

SD Aluminium **CANOPY SYSTEMS** PRODUCT CATALOGUE

*Smart Shelter Solutions
Strength, Style, and All season Performance*

2026-2027 Edition

Our Story ...

At SD Aluminium, we build outdoor spaces that go beyond shelter — creating year-round comfort with adaptable canopy systems. From robust structures to insulated roofing and smart enclosures, our canopy solutions transform open areas into usable, protected living zones.

Whether you're extending a patio, enclosing a deck, or designing a freestanding cover, our modular systems provide strength, style, and peace of mind for worry-free outdoor living.

Transform Outdoor Spaces, Seamlessly

Every element of our canopy range is designed to work together — combining strength, insulation, and customisation for all-season performance. Choose from integrated blinds, doors, or windows to complete the space and create a functional outdoor room tailored to your lifestyle.

Aluminium Canopy System

<i>Project Gallery</i>	_____	1 - 3
<i>A3 Canopy System</i>	_____	4 - 6
<i>A5 Canopy System</i>	_____	7 - 8
<i>A8 Canopy System</i>	_____	9 - 10
<i>Aluminium Insulated Roofing System</i>	_____	11 - 13
<i>Canopy Blind System</i>	_____	14
<i>Canopy Window & Door System</i>	_____	15
<i>Canopy System Accessories</i>	_____	16 - 17
<i>Colour Options</i>	_____	18



Shade. Shelter. Style. _____

**DESIGNED FOR
THE WAY YOU LIVE.**

A3 CANOPY System

- Sleek, modern shelter for patios, decks, or driveways.
- Protects from sun and rain while enhancing outdoor living.
- Ideal for both residential homes and small commercial spaces.



A5 CANOPY System

- Built for NZ conditions with proven all-weather performance.
- Modular design allows flexible sizing and configurations.
- Add side blinds or insulated roofing for comfort and privacy.



A8 CANOPY System

- Clean, low-maintenance structure with lasting durability.
- Integrates easily with existing architecture or landscaping.
- Installation-friendly design for efficient on-site assembly.



A3 Canopy System Straight Edge System

Cross Section Instruction

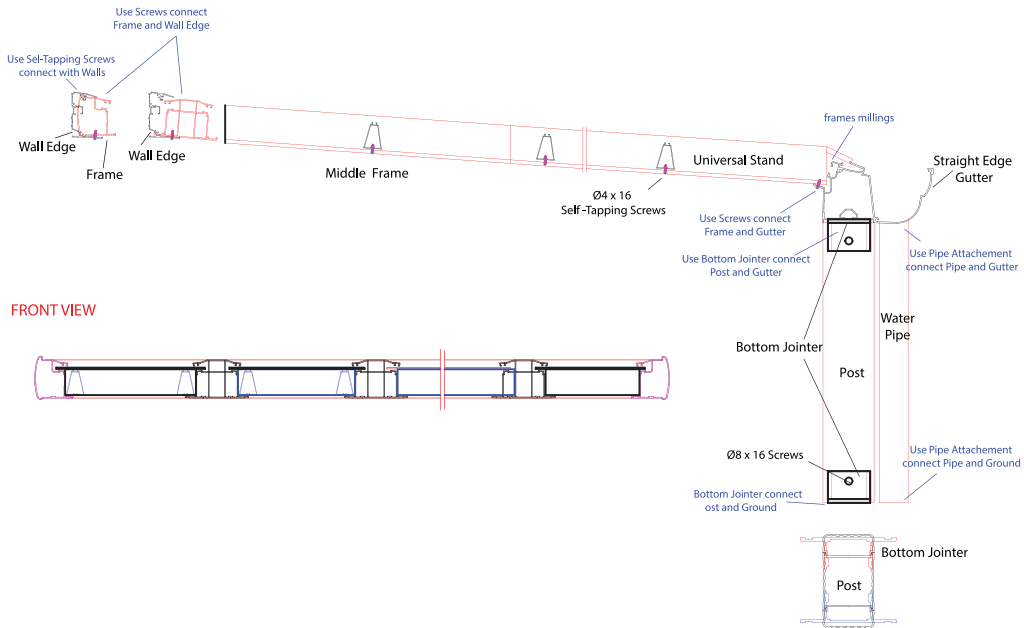

A3 Canopy System Radius Edge System

Cross Section Instruction

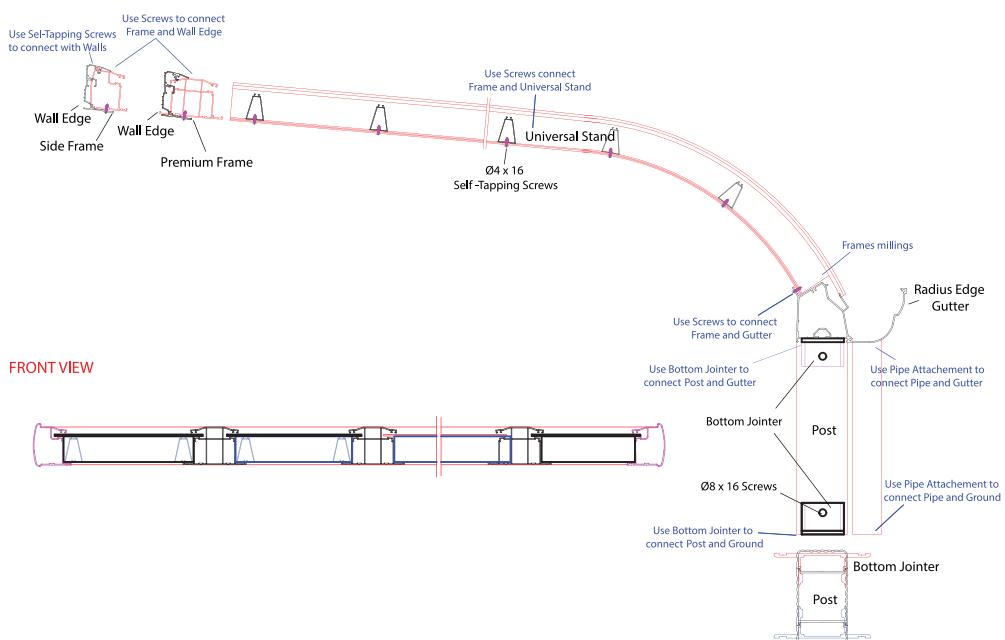

A3 Canopy Carport System

Cross Section Instruction

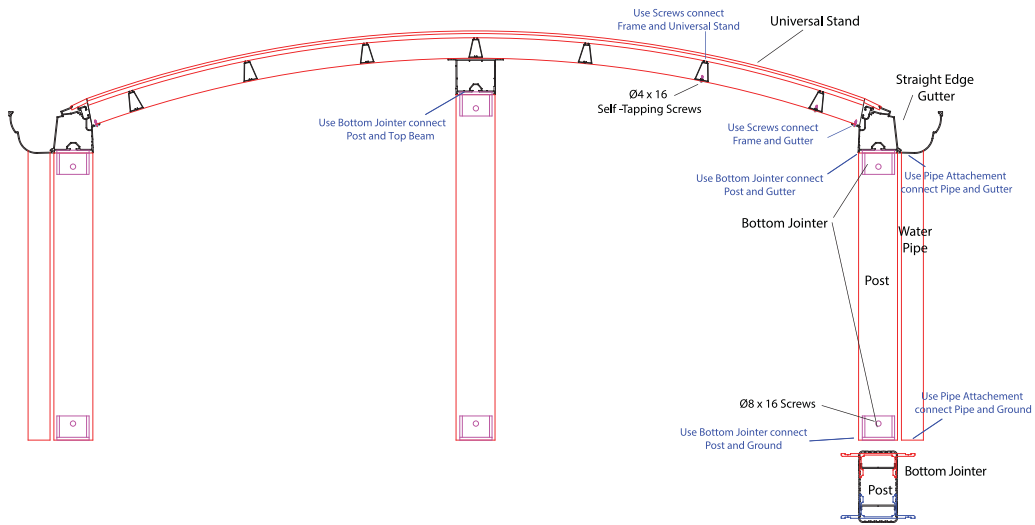

A3 Canopy Cantilever System - Radius Edge

Cross Section Instruction

SIDE VIEW

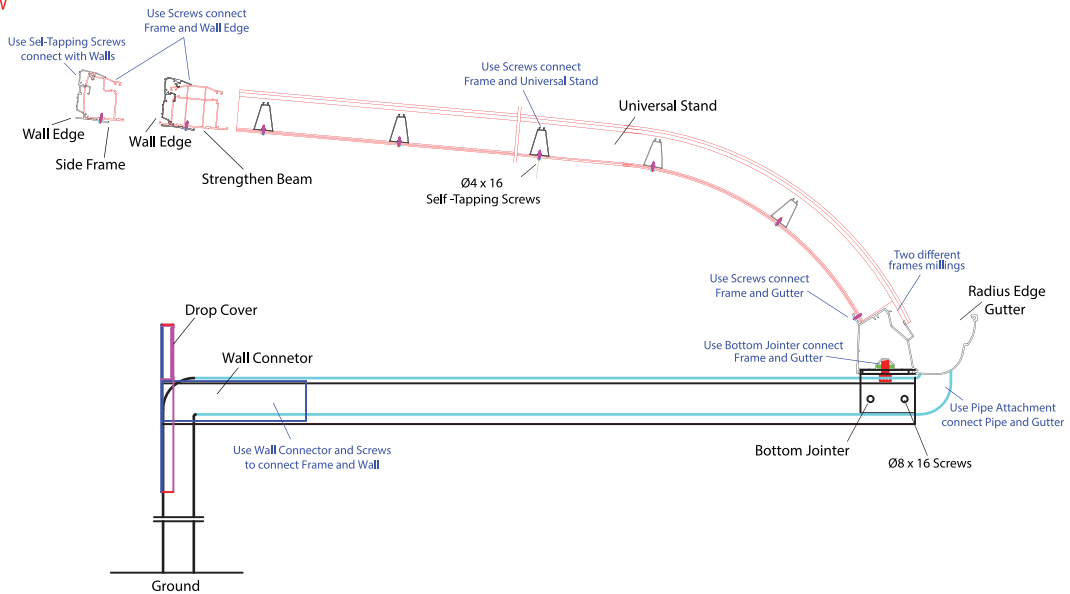

FRONT VIEW

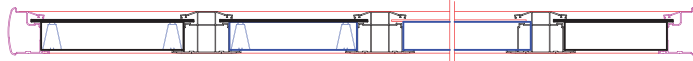

A3 System Profiles

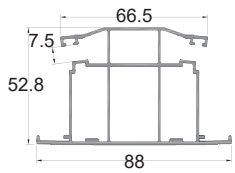

GM-NEWZ-Y13005
A3 - Premium Frame

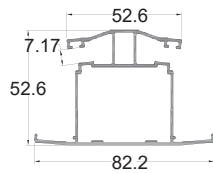

GM-NEWZ-Y13006
A3 - Standard Frame

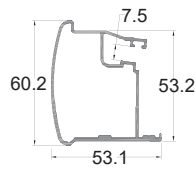

GM-NEWZ-Y13008
A3 - Side Frame

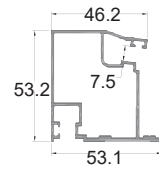

GM-NEWZ-Y13065
A3 - 2-Way Slot Frame

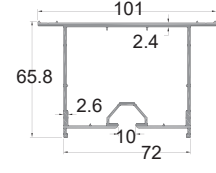

GM-NEWZ-Y13003
A3 - Flat Top Beam

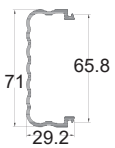

GM-NEWZ-Y13002
A3 - Pillar Cap

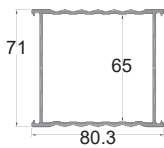

GM-NEWZ-Y13002
A3 - Pillar

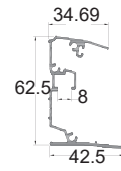

GM-NEWZ-Y13007
A3 - Wall Edge



GM-NEWZ-95x3.5LB
A3 - Wall Edge Cap



GM-NEWZ-Y13072
A3 - Wall Edge with Slot

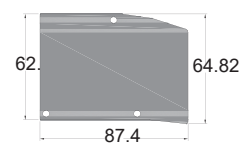

SL-449
A3 - Wall Edge Cap

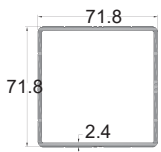

GM-NEWZ-Y13026
A3 - Pillar (New Style)

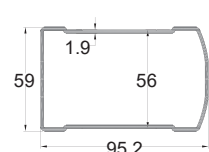

GM-NEWZ-Y13038
A3 - Window Shed Main Beam



GM-NEWZ-Y13039
A3 - Drop Cover

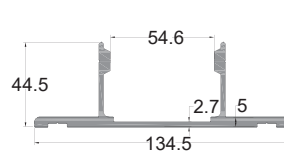

GM-NEWZ-Y13004
A3 - Bottom Joints (Style #1)

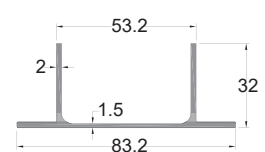

GM-NEWZ-Y13025
A3 - Bottom Joints (Style #2)

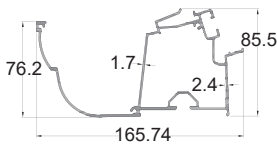

GM-NEWZ-Y13011
A3 - Straight Edge Gutter



GM-NEWZ-Y13012
A3 - Radius Edge Gutter

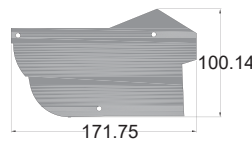

A3 Gutter End Cap

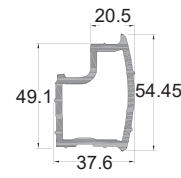

GM-NEWZ-Y13024
A3 - Frame Extend Ferrule

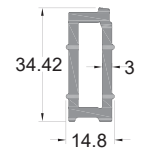

GM-NEWZ-Y13022
A3 - Frame Extend Pillar

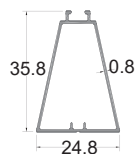

GM-NEWZ-Y13009
A3 - Frame Support Bar

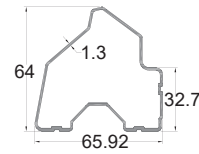

GM-NEWZ-Y13010
A3 - Gutter Extend Ferrule



SL-122
A3 - Gutter Corner Joints

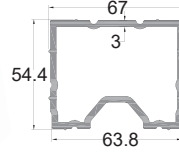

GM-NEWZ-Y13023
A3 - Top Beam Extend Ferrule

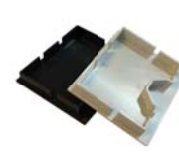

SL-145
A3 - Top Beam Cap



SL-120
A3 - Flat Joints
130x20x3mm



SL-148
A3 - Cantilever
Wall Mount Cover



SL-149
A3 - Cantilever



SL-134
A3 / A5 - 90°
Joints



Mounting Screw
Ø9.4x106mm



Mounting Screw
Wall Plug



Mounting Screw
Hex Hole Cap

A5 Canopy Straight Edge System

Cross Section Instruction

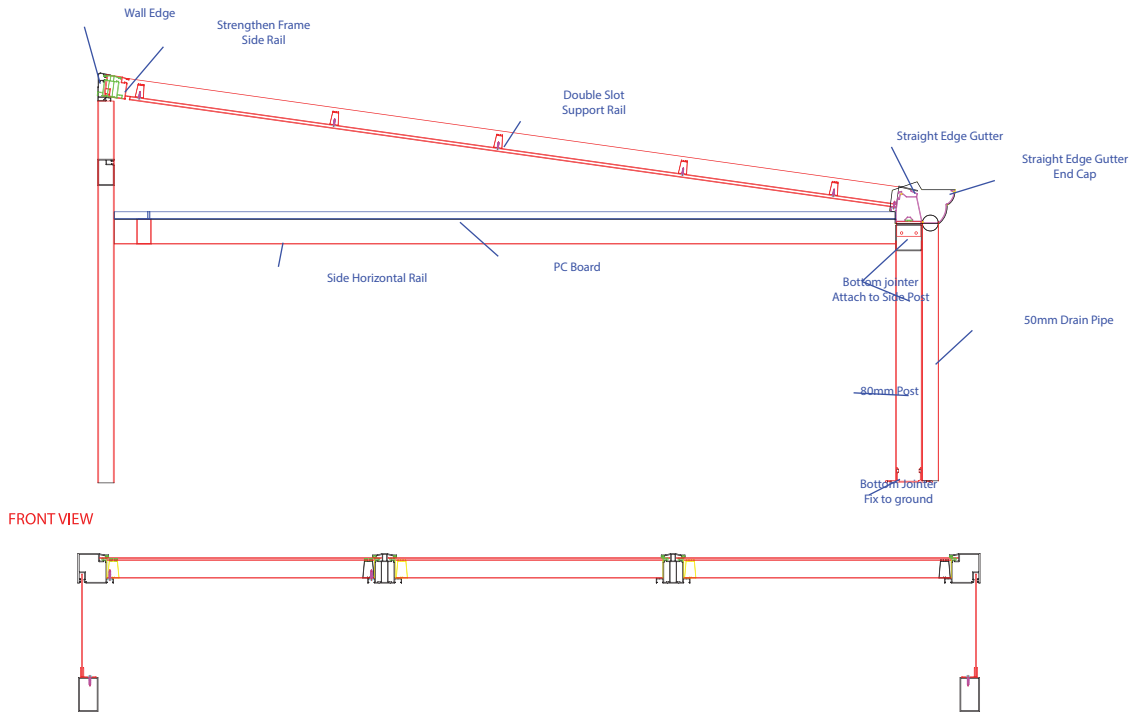

A5 Canopy Radius Edge System

Cross Section Instruction

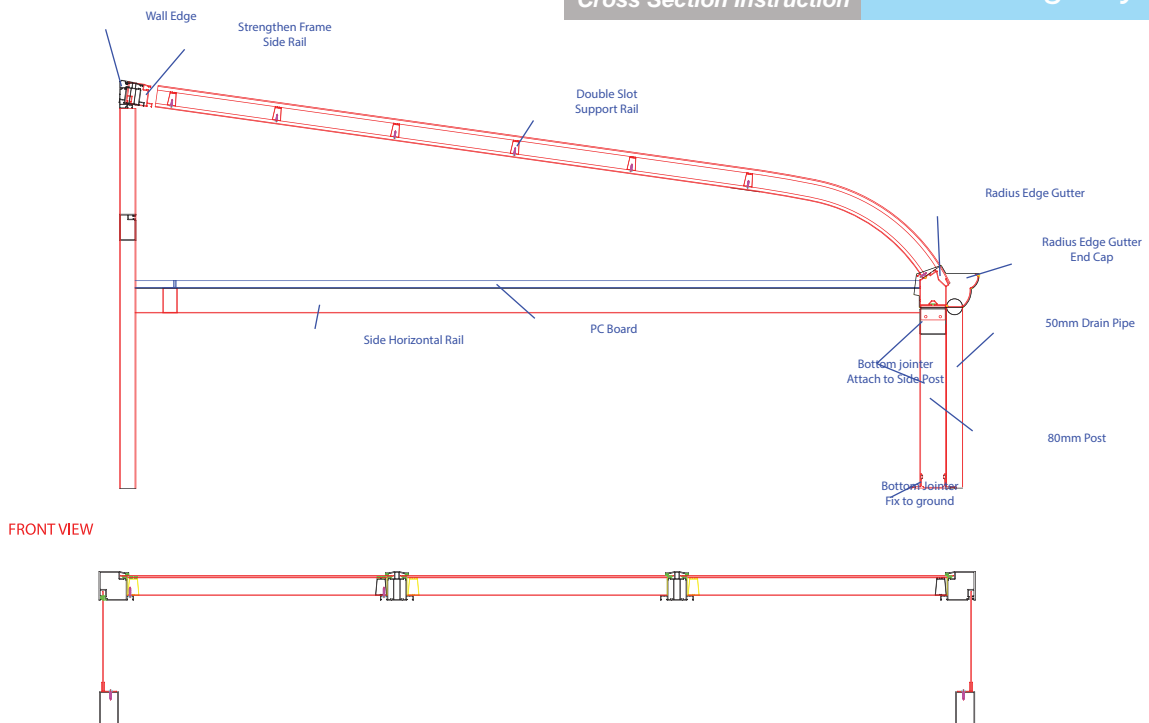

A5 Canopy Carport System

Cross Section Instruction

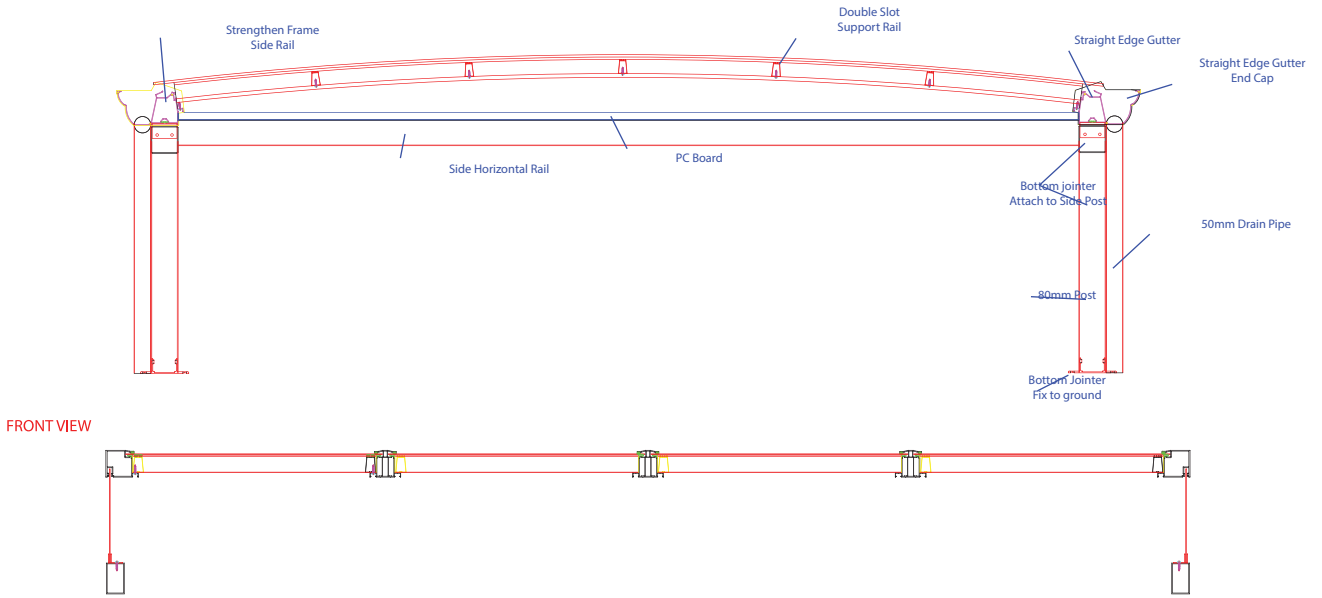

A5 System Profiles

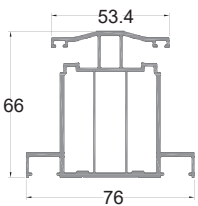

GM-NEWZ-Y13060
A5 - Strengthen Frame

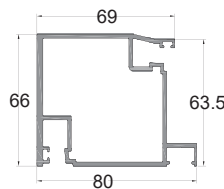

GM-NEWZ-Y13062
A5 - Side Frame

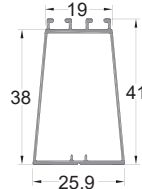

GM-NEWZ-Y13061
A5 - Frame Support Bar Double Slots

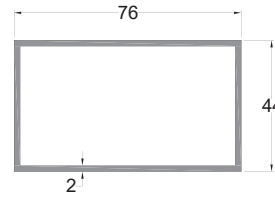

GM-76x44x2.0
A5 - Side Horizontal Rail

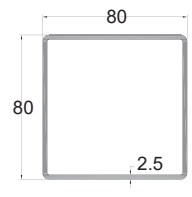

GM-80x80x2.5R
A5 - 80mm Post

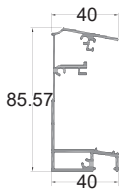

GM-NEWZ-Y13059
A5 - Wall Edge

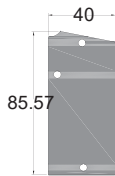

GM-NEWZ-95x3.5LBA5
A5 - Wall Edge Cap

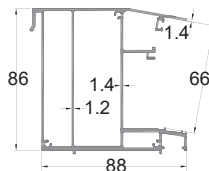

GM-NEWZ-Y13071
A5 - Wall Edge with Slot

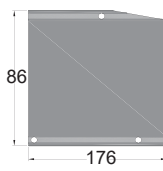

SL-448
A5 - Wall Edge Cap

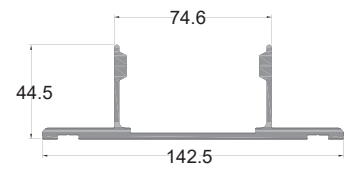

GM-NEWZ-Y13058
A5 - Post Flange Plate

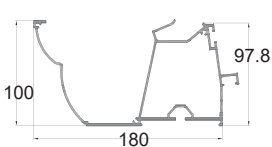

GM-NEWZ-Y13063
A5 - Straight Edge Gutter



GM-NEWZ-Y13064
A5 - Radius Edge Gutter

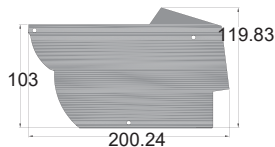

GM-JZMB-71A5
A5 - Gutter End Cap



SL-261
A5 - Flat Joints
140x20x3mm



SL-134
A3 / A5 - 90° Joints

A8 Canopy Straight Edge System

Cross Section Instruction

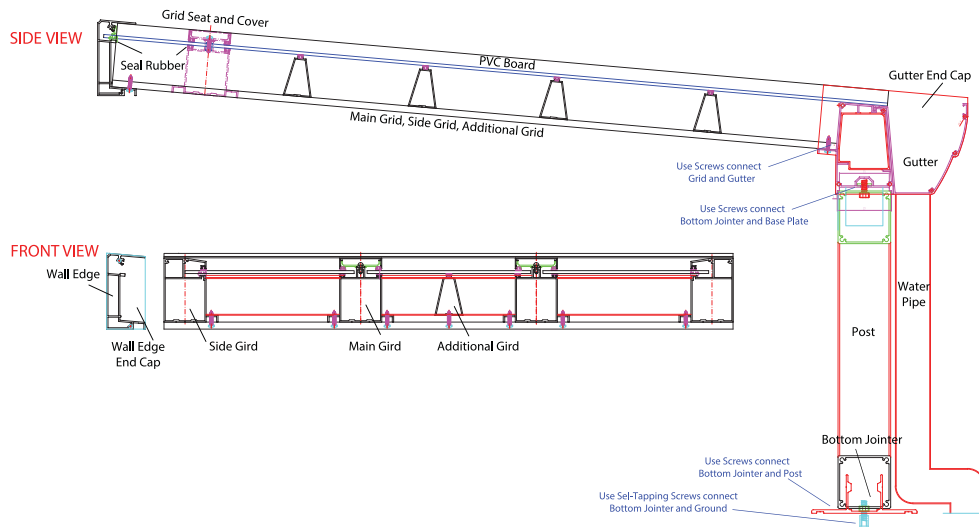

A8 Canopy Cantilever System - Radius Edge

Cross Section Instruction

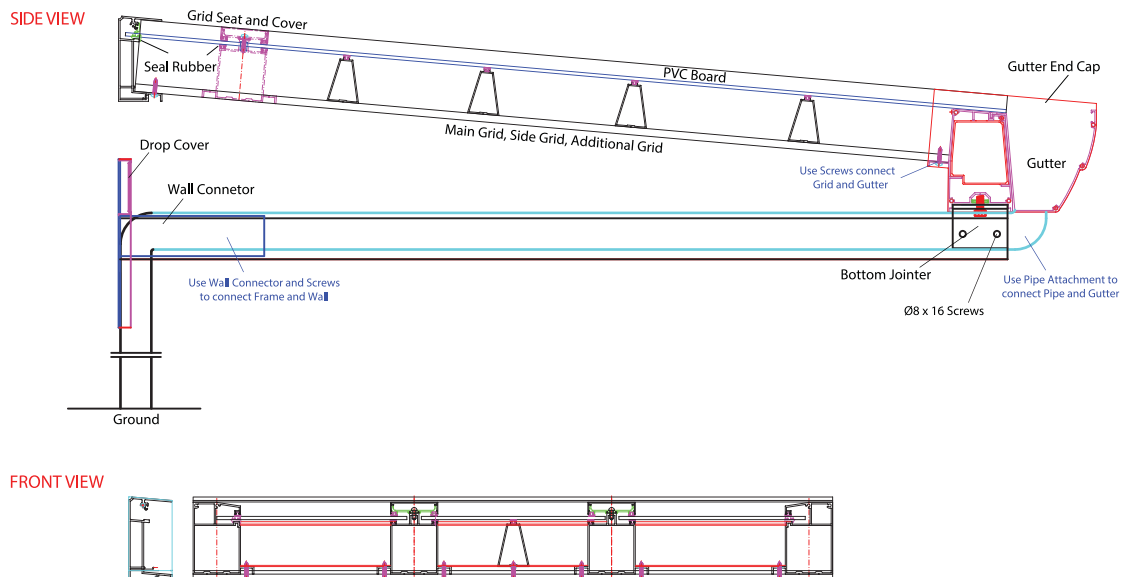

A8 System Profiles

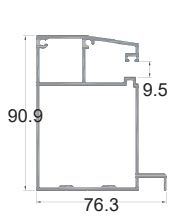

GM-NEWZ-Y13032
A8 - Side Girder

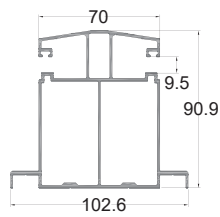

GM-NEWZ-Y13066
A8 - Strengthen One-piece Girder

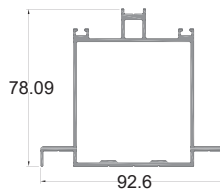

GM-NEWZ-Y13028
A8 - Strengthen Girder

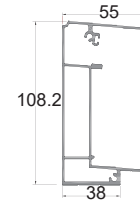

GM-NEWZ-Y13031
A8 - Fixed Wall Eaves

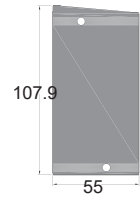

SL-185
Wall Eaves Cap

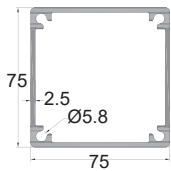

GM-NEWZ-48
A8 - 75mm Strengthen Post

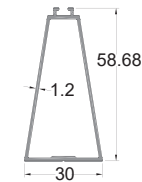

GM-NEWZ-Y13033
A8 - Strengthen Support Bar

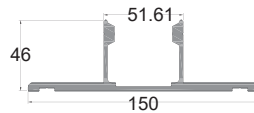

GM-NEWZ-Y13036
A8 - Bottom Joister (Style #3)

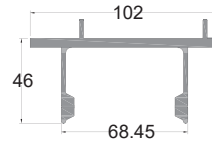

GM-NEWZ-Y13040
A8 - Bottom Joister for 100mm

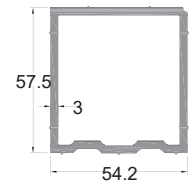

GM-NEWZ-Y13027
A8 - Main Girder Ferrule

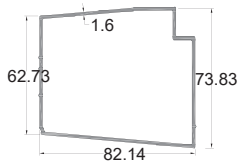

GM-NEWZ-Y13040
A8 - Bottom Joister for 100mm

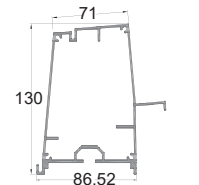

GM-NEWZ-Y13034
A8 - Strengthen Front Girder

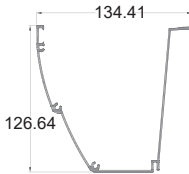

GM-NEWZ-Y13035
A8 - Strengthen Gutter

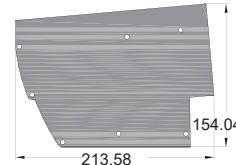

GM-JL-70
A8 - Gutter End Cap



SL-146
A8 - Flat Joister
146x20x3mm



GM-NEWZ-Y13030
A8 - Strengthen Girder Cap

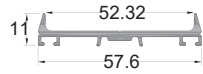

GM-NEWZ-Y13029
A8 - Strengthen Girder Seat

Canopy Universal Accessories & Components

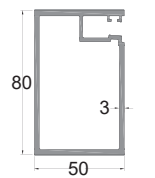

GM-NEWZ-Y13056
Universal - Side Post

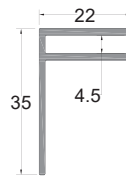

GM-NEWZ-Y13057
Universal - Board Holder

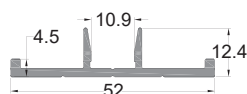

GM-NEWZ-117
4.2mm PC Board Base

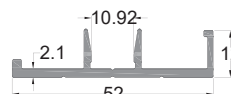

GM-NEWZ-191
4.2mm PC Board Side Base



GM-NEWZ-118
4.2mm PC Board Clip

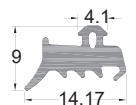

R19
Cap Strip
For 117/118

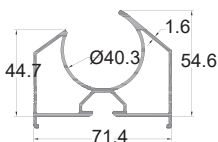

GM-NEWZ-Y13069
Universal - Top Beam
Pivot Slot

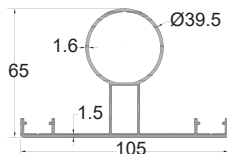

GM-NEWZ-Y13070
Universal - Top Beam
Pivot Pin

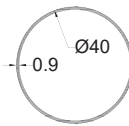

RTD40T0.9
Universal - Ø40mm
Drain Pipe



RTD49.5T0.8
Universal - Ø49.5mm
Drain Pipe

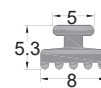

RS1
Universal Strip
Profile #1

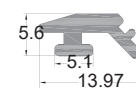

RS2
Universal Strip
Profile #2

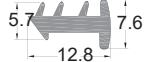

RS3
Universal Strip
Profile #3



PC Endurance Board
2.0mm / 3.0mm



SL-114
Ø40mm Pipe
Corner Jointer



SL-116
Ø40mm Pipe
Clamp



SL-115
Ø40mm Pipe
Flange



SL-254
Ø50mm Pipe
Corner Jointer



SL-256
Ø50mm Pipe
Clamp



SL-255
Ø50mm Pipe
Flange

Insulated Roofing Canopy System

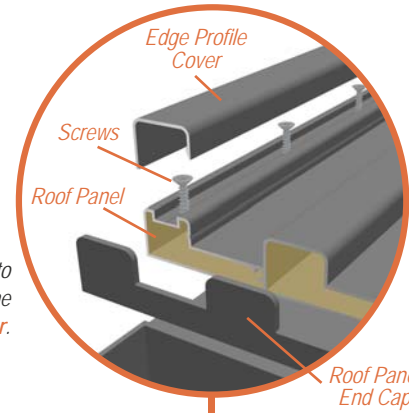
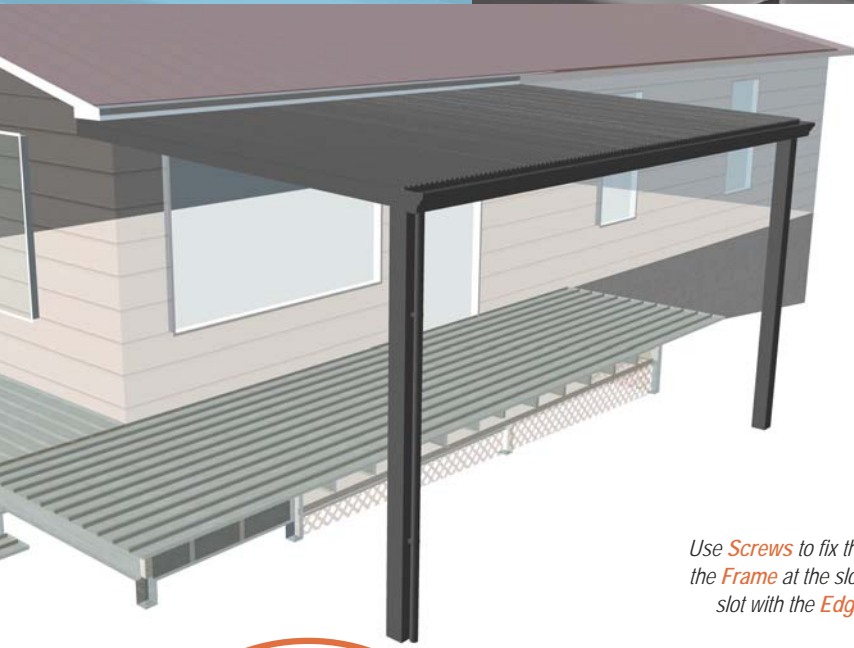

Use **Screws** to fix the **Roof Panel** to the **Frame** at the slot, then cover the slot with the **Edge Profile Cover**.

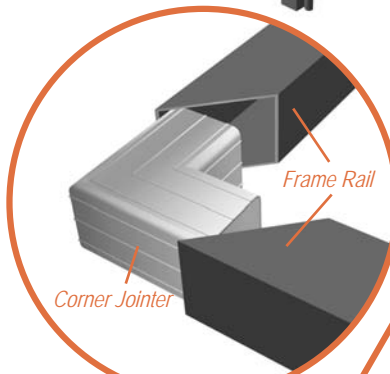

Cut the **Rails** to **45°** and insert the **Corner Jointer** when setting corners. Then, use the **Post Bracket** to connect to the **Post**.

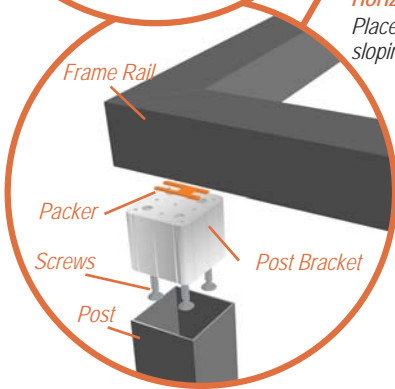

Use the **Post Bracket** to connect the **Horizontal Frame Rail** to the **Post**. Place **Packers** if needed to adjust the sloping angle.

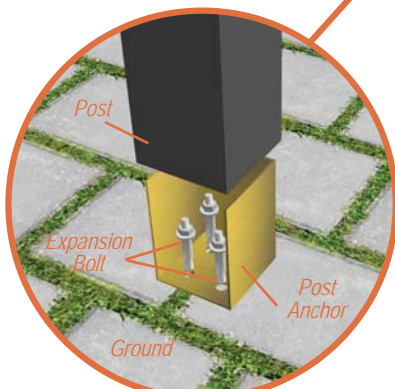

To set the **Post**, place the **Post Anchor** and fix it with **4 X Expansion Bolts**, then slid the **Post** over the **Anchor**.

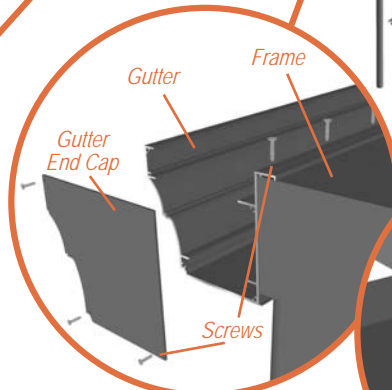
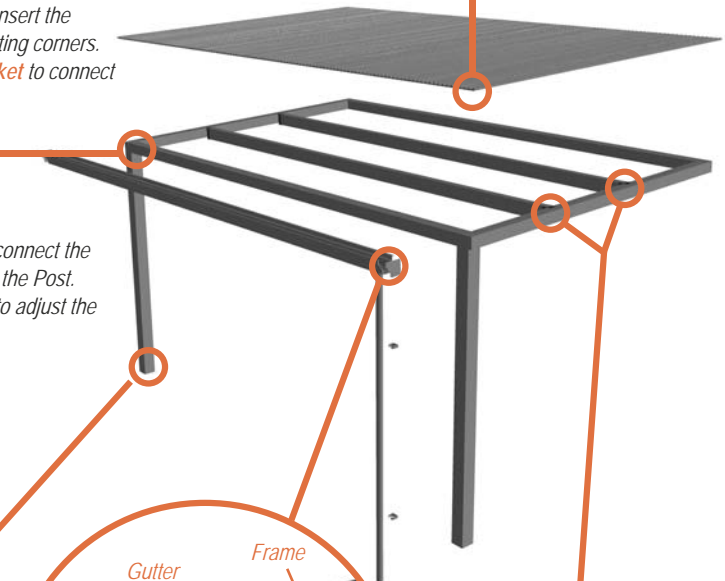

Set the **Gutter** on the edge of the **frame**, then use **Screws** to fix it to the **frame**.

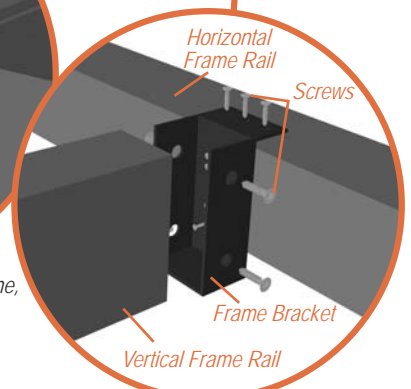

To install **Cross Rail**, Mount the **Frame Bracket** to the **Horizontal Rail**, then fix the **Vertical Rails** to the **bracket**.

Insulated Roofing Kennel System

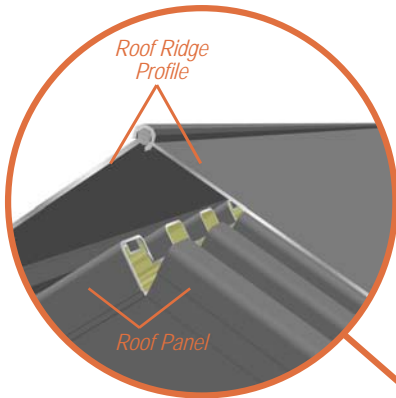

Our innovative **Ridge System** uses a two-piece design where one profile slides into another, creating an **Interlocking, Waterproof System**.

The ridge profile is securely fastened to the roof panel using **Screws** at designated ports. Finally, a **Cover plate** is applied to conceal the screw ports, resulting in a sleek appearance.

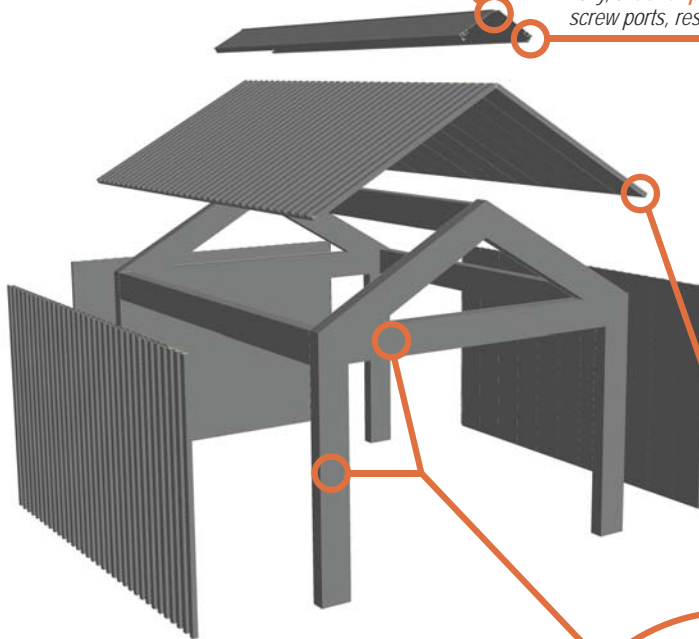
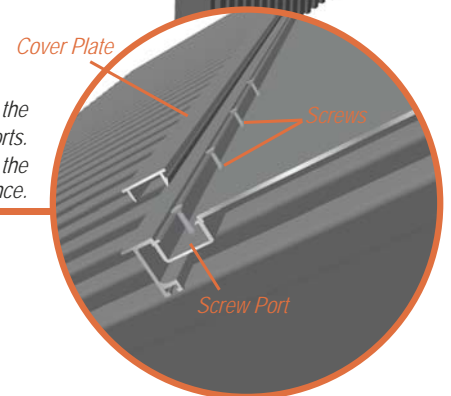

Use **Screws** to fix the **Roof Panel** to the **Frame** at the slot, then cover the slot with the **Edge Profile Cover**.

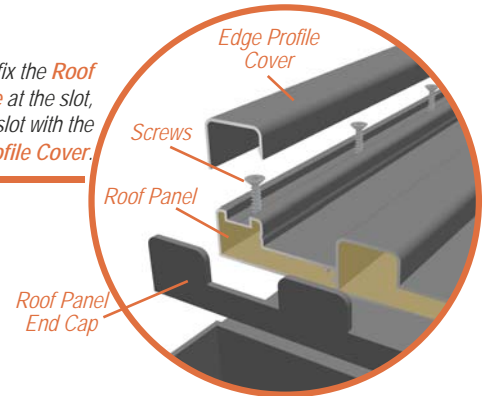

The **Frame** of this system can be **Fully Customized** to suit your preferences, whether you desire a steep sloped roof or a nearly flat one. The **Rail** profiles are also adjustable, allowing you to tailor the design to perfectly match your project requirements.

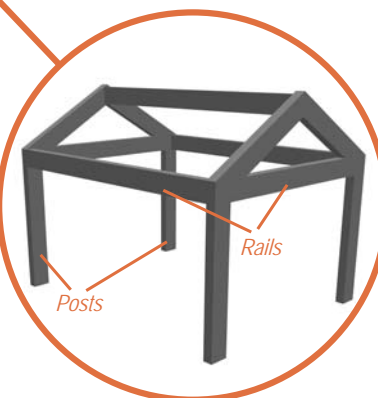

Insulated Roofing Profiles

Cross Section Instruction

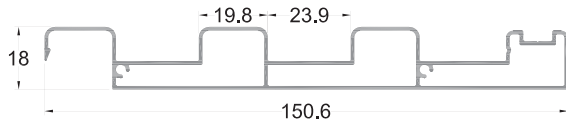

GM-NEWZ-CCB01
Great Wall Roofing Tile

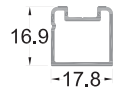

GM-NEWZ-CCB02
Size Edge Profile



GM-NEWZ-CCB03
Side Edge Profile Cover

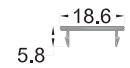

GM-NEWZ-CCB06
Cover Plate

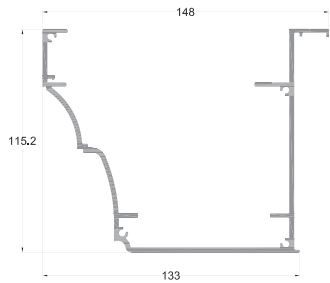

GM-LT-27
Roofing Gutter



SL-322
Roofing Gutter End Cap



GM-NEWZ-CCB04
Ridge Profile 1



GM-NEWZ-CCB05
Ridge Profile 2

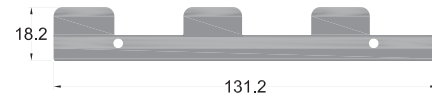

SL-223
Roofing Tile End Cap



SL-262
Roof Panel Connector

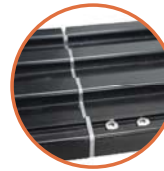
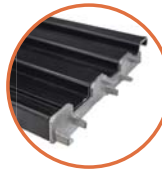

Roof Panel Connector
Application

Great Wall Roofing Canopy Posts & Rails

Post Options

Product Code	Dimension	Length
GM-NEWZ-75x75x3R	75x75x3.0mm	5.95m
GM-NEWZ-80x80x2.5R	80x80x2.5mm	5.95m
GM-NEWZ-100x100x3	100x100x3.0mm	5.95m
GM-NEWZ-120x120x3	120x120x3.0mm	5.95m

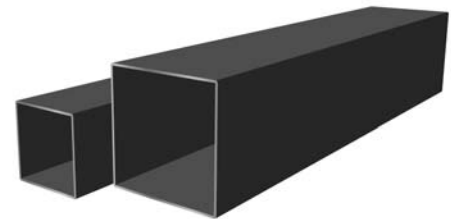

Rail Options

Product Code	Dimension	Length
GM-NEWZ-80x80x2.5R	80x80x2.5mm	5.95m
GM-100x44x3.0	100x44x3.0mm	5.95m
GM-NEWZ-100x50x3	100x50x3.0mm	5.95m
GM-120x60x3	120x60x3.0mm	5.95m

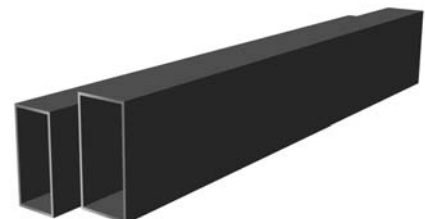

Canopy Blind Extrusion Profiles

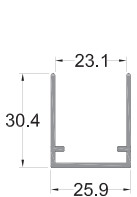

GM-NEWZ-175
0.357kg/m

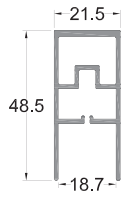

GM-NEWZ-174
0.679kg/m

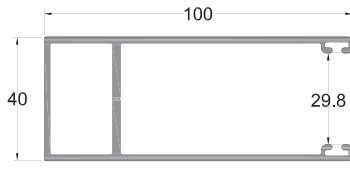

GM-NEWZ-173
1.680kg/m

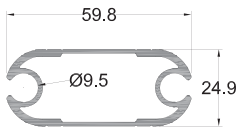

GM-NEWZ-172
0.901kg/m

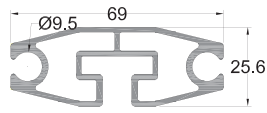

GM-NEWZ-171
1.360kg/m

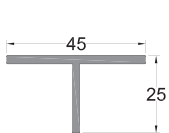

GM-NEWZ-45x25x2.5T
0.480kg/m



GM-NEWZ-130x30x1.8JL
0.811kg/m



Sliding Door System

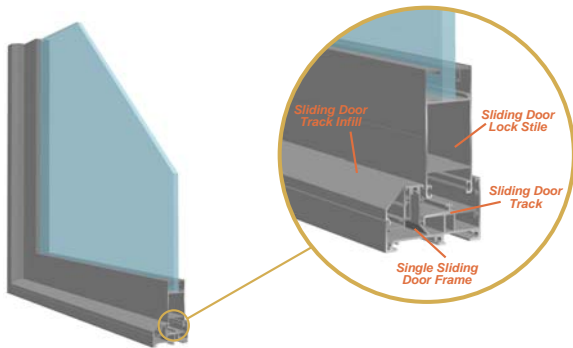

Our **Sliding Door** system offers a sleek and functional solution for modern spaces.

Featuring a **Lock Stile** around the glass door panel, the design ensures security and elegance. The **Sliding track** is seamlessly integrated into the door frame, while the **Castor Wheel** is securely fixed to the door panel.

This allows the door to glide smoothly along the track, providing effortless operation and a stylish aesthetic for any room.

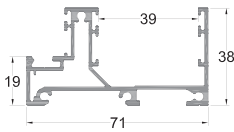

GM-NEWZ-W66
Single Sliding Door Frame

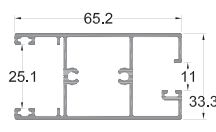

GM-NEWZ-W67
Sliding Door Top Bottom Stile

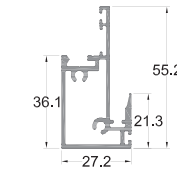

GM-NEWZ-W69
Sliding Door Interlock Mullion



GM-NEWZ-W49
Sliding Door Track

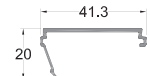

GM-NEWZ-W48
Sliding Door Track Infill - Large

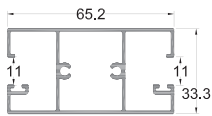

GM-NEWZ-W68
Sliding Door Mid Horizontal Stile

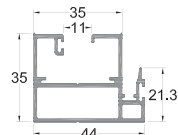

GM-NEWZ-W70
Sliding Door Interlock Stile

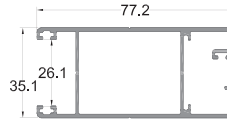

GM-NEWZ-W71
Sliding Door Vertical Stile



GM-NEWZ-W03
Double Glaze Bead

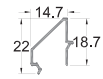

GM-NEWZ-W72
Sliding Door Track Infill - Small

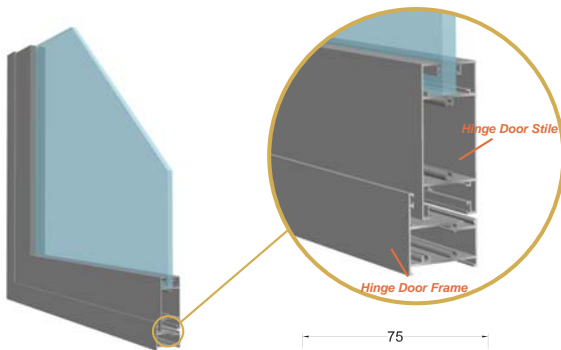

Hinge Door System

Our **Hinge Door** system is designed for simplicity and durability. The glass panel is inserted directly into the **Hinge Door Stile**, creating a clean and contemporary look. The door panel is then securely attached to the **Hinge Door Frame**, ensuring stability and ease of use.

This straightforward system is perfect for those seeking a classic door solution with reliable performance.

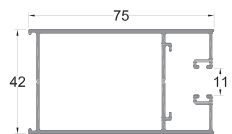

GM-NEWZ-W63
Hinge Door Vertical Stile

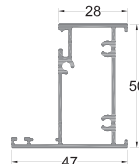

GM-NEWZ-W62
Hinge Door Frame

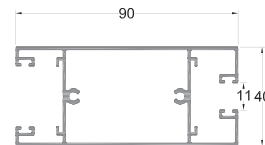

GM-NEWZ-W64
Hinge Door Horizontal Stile

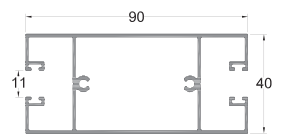

GM-NEWZ-W65
Hinge Door Middle Stile

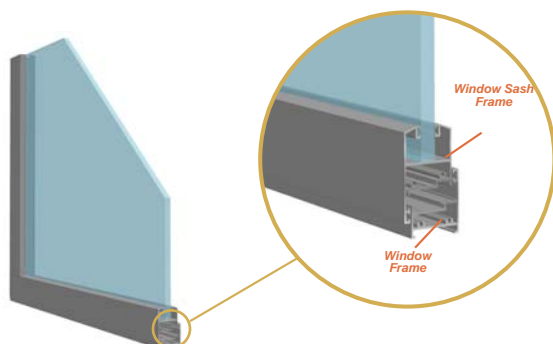

Window System

Our **Window System** combines functionality and ease of assembly. The **Window Sash** is meticulously constructed and then effortlessly sealed into the **Window Frame**. This design not only ensures a snug fit but also enhances the overall aesthetic of the window.

Ideal for a variety of applications, this system provides a reliable and visually appealing window solution.

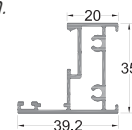

GM-NEWZ-W60
Window Frame

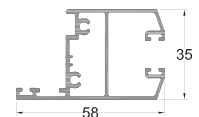

GM-NEWZ-W61
Window Sash

Frame Brackets & Anchors



SL-212
Aluminium
Corner Jointer
for 100mm



SL-207
Aluminium
Corner Jointer
for 120mm



SL-209
Aluminium
Straight Jointer
for 100mm



SL-210
Aluminium
Straight Jointer
for 120mm



SL-211
Aluminium
Frame Anchor
for 100mm



SL-208
Aluminium
Frame Anchor
for 120mm



SL-198
Galvanized Steel
Post Anchor
for 100mm

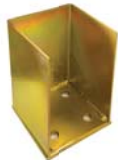

SL-199
Galvanized Steel
Post Anchor
for 120mm



SL-200
Galvanized Steel
Post Anchor
for 150mm



SL-206
304 Stainless Steel
Frame Bracket
for 80x80mm



SL-203
304 Stainless Steel
Frame Bracket
for 100x44mm



SL-205
304 Stainless Steel
Frame Bracket
for 100x50mm

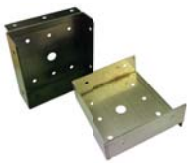

SL-202
304 Stainless Steel
Frame Bracket
for 100x100mm



SL-204
304 Stainless Steel
Frame Bracket
for 120x60mm



SL-201
304 Stainless Steel
Frame Bracket
for 120x120mm

Other Accessories



Fixing Screw
304 Stainless Steel
M4x16mm



Fixing Bolt
304 Stainless Steel
Hex Head Bolt



HD-108
Kitchen & Bathroom
Sealant



HD-101
General Purpose
Sealant



SS-850
Window & Door
Sealant



SS-511B
Silicone Sealant



JS-8611
Silicone Drip-less
Caulking Gun



JS-8613-B
Silicone Sealant
Caulking Gun

Extrusion Powder Coating

Our powder coating aluminium provides an attractive, durable, and cost-effective solution that is environmentally friendly and customisable to suit a wide range of design needs.

Durability: Powder coated aluminium is extremely durable and can withstand harsh weather conditions, including extreme heat, cold, and humidity. The powder coating also provides protection against scratches, chipping, and fading, which makes it an ideal choice for outdoor applications.

Aesthetics: It provides a smooth, even finish that is available in a wide range of colours and textures. This allows for customisation and flexibility in design choices, making it an attractive option for architectural, automotive, and consumer applications.

Environmental Sustainability: Powder coating is an environmentally friendly alternative to liquid paint. It produces very little waste, and the overspray can be collected and reused, reducing waste and saving on material costs. Additionally, powder coating does not emit any volatile organic compounds (VOCs) into the air, making it a safer option for the environment.

Stocked Colours

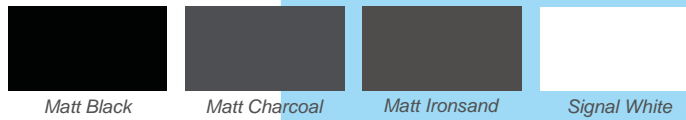

Matt Black

Matt Charcoal

Matt Ironsand

Signal White

*** NOTE:** Custom colours are available upon request, additional costs and lead times may apply.

PC Sheet Options

Using PC boards for canopy construction provides a durable, versatile, and cost-effective solution that can enhance the aesthetics of any residential spaces.

Durability: PC boards are resistant to impact, weathering, and UV radiation, making them an excellent choice for outdoor canopy.

Light Transmission: PC boards have excellent light transmission properties, allowing natural light to filter through the canopy while protecting against UV radiation.

Lightweight: PC boards are lightweight, making them easy to handle and install.

Cost-effective: A cost-effective alternative to glass or acrylic for canopy construction, offering similar benefits at a lower price point.

Stocked Colours

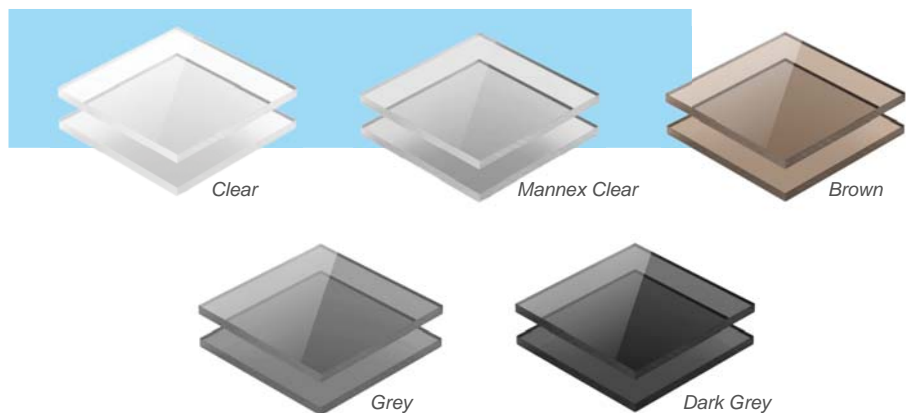

Clear

Mannex Clear

Brown

Grey

Dark Grey



ALUMINIUM

Contact Us Now!

Auckland Rosedale Branch

Address: *6 John Glenn Ave, Rosedale,
Auckland 0632*

Email: *info.albany@sdalu.co.nz*

Phone: *09 - 218 2188
09 - 218 2111*

Auckland Manukau Branch

Address: *28 Ryan Pl, Manukau City,
Auckland 2104*

Email: *info.manukau@sdalu.co.nz*

Phone: *09 - 217 8666*

Christchurch Wigram Branch

Address: *67 Vickerys Rd, Wigram,
Christchurch 8042*

Email: *info.chch@sdalu.co.nz*

Phone: *03 - 366 6669*

Follow Us on Social Media

