

SD Aluminium CONSTRUCTION & LANDSCAPING PRODUCT CATALOGUE

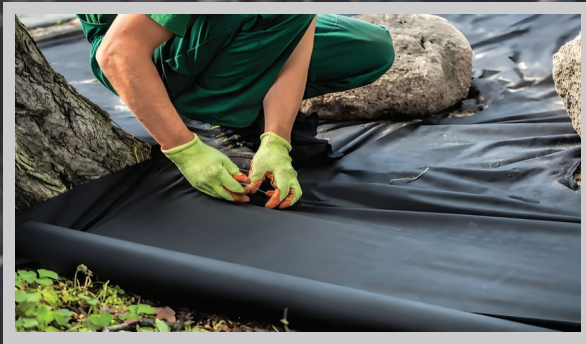

2026-2027 Edition

CONSTRUCTION & LANDSCAPING SOLUTIONS



Site Damp Control

| | | |
|------------------------------|-------|---|
| <i>DPM</i> | _____ | 1 |
| <i>Drainage Board</i> | _____ | 1 |
| <i>Silt Fence & Clip</i> | _____ | 2 |

Surface Protection Solutions

| | | |
|--------------------------|-------|---|
| <i>Floor Protection</i> | _____ | 3 |
| <i>Carpet Protection</i> | _____ | 3 |

Garden Essential Range

| | | |
|--|-------|-------|
| <i>Weed Mat</i> | _____ | 4 |
| <i>Geotextile Fabric</i> | _____ | 5 |
| <i>Garden Edge System</i> | _____ | 6 |
| <i>Artificial Turf & Lawn Solution</i> | _____ | 7 - 8 |

Safety Mesh

| | | |
|--|-------|---|
| <i>Commercial & Residential Roof Fall Mesh</i> | _____ | 9 |
|--|-------|---|

Fence Mesh Solutions

| | | |
|---|-------|----|
| <i>Chain Link Fence Mesh</i> | _____ | 10 |
| <i>Sheep Fence Mesh</i> | _____ | 11 |
| <i>Hex Fence Mesh</i> | _____ | 11 |
| <i>Square Welded Fence Mesh</i> | _____ | 12 |
| <i>Euro Fence Mesh</i> | _____ | 12 |
| <i>Orange Safety Fence Mesh & Cable Tie</i> | _____ | 13 |

Fence Wire Solutions

| | | |
|--|-------|----|
| <i>High Tensile & Standard Fence Wire</i> | _____ | 14 |
| <i>Razor Fence Wire</i> | _____ | 15 |
| <i>Barbed Fence Wire</i> | _____ | 16 |
| <i>Galvanised Steel Post Range</i> | _____ | 17 |
| <i>Y-Post & Accessories</i> | _____ | 18 |
| <i>Tie Wire Range</i> | _____ | 19 |
| <i>Fence Mesh Range Toll & Accessories</i> | _____ | 20 |

Temporary Fencing System

| | | |
|------------------------------------|-------|----|
| <i>Temporary Fence Panel</i> | _____ | 21 |
| <i>Temporary Fence Accessories</i> | _____ | 21 |

A wide-angle landscape photograph showing rolling hills, green fields, and a range of blue mountains in the distance. In the foreground, a fence line runs across the field, and a person is visible near a piece of machinery.

Complete range of construction and landscaping materials for residential, commercial, and outdoor projects.

Site Damp Control Solutions

DPM - Damp Proof Membrane (Concrete Underlay)

Thickness: 200um (0.2mm)
Material: PE - Polythene



| Code | Width | Roll Length | Color | Weight |
|-----------|-------|-------------|-------|--------|
| DPMW1L50 | 1m | 50m | Black | 13.8kg |
| DPMW4L25 | 4m | 25m | Black | 27.6kg |
| DPMW4L25W | 4m | 25m | White | 27.6kg |



Our polythene Damp Proof Membrane, available in black and white, provides essential moisture protection for concrete foundations and flooring. With a thickness of 200µm, it's designed to prevent rising damp and protect against moisture infiltration in residential and commercial projects. Ideal for use under concrete slabs and walls.

*This product is conveniently folded and rolled into a 1m-wide roll for easy handling and installation.

Drainage Board - Dimpled Sheet

Thickness: 600um (0.6mm)
Dimple Height: 8.0mm
Material: Composite plastic polymer
Max Load: 250KN/m²

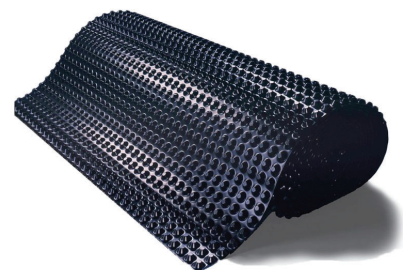

| Code | Width | Length | Color | Weight |
|------------|-------|--------|-------|--------|
| DBW1.2L2.1 | 1.2m | 2.1m | Black | 1.51kg |



Our 0.6mm Drainage Board, or dimpled sheet, is designed for efficient water management. It prevents hydrostatic pressure buildup and directs water away from foundations. Suitable for various applications, including basements and foundation walls, this durable board ensures long-lasting moisture protection and structural stability.

Site Damp Control Solutions

Silt Fence

Material: Woven Geotextile Fabric

Feature: UV Stabilised
High Water Flow Rate



| Code | Height | Length | Color | Weight |
|---------|--------|--------|-------|--------|
| SFH1L50 | 1.0m | 50m | Green | 5.0kg |



Our silt fence is crafted from UV-stabilized woven geotextile fabric, providing effective sediment control with a high water flow rate to prevent soil erosion without blocking drainage. Available in black or green. It's ideal for construction sites, landscaping, and soil management applications.

Silt Fence Clip

Material: UV Stabilised
PP - Polypropylene



| Code | Diameter | Weight |
|-------|----------|--------|
| SL370 | Ø38mm | 7.2g |

The silt fence clip, also known as a butterfly clip, securely fastens silt fencing to wire, providing a quick and stable hold. Perfect for use in construction, landscaping, and erosion control setups, this clip ensures reliable attachment to withstand environmental conditions.

Surface Protection Solutions

Floor Protection - with Build-in cushion

Material: **PP - Polypropylene**
 Feature: **Slip Resistant Patten**

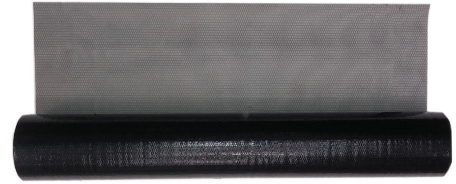
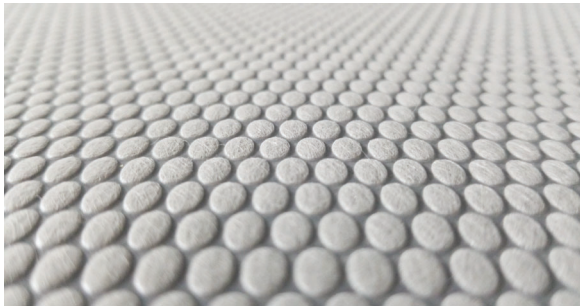

| Code | Width | Roll Length | Weight |
|-------------|-------|-------------|--------|
| FPFH0.5L100 | 0.5m | 100m | 4.5kg |
| FPFH1L100 | 1.0m | 100m | 9.8kg |
| FPFH1.2L100 | 1.2m | 100m | 10.7kg |



This premium floor protector combines a soft cushion layer with a slip-resistant pattern for enhanced durability and safety. Designed to absorb spills quickly, it protects against scratches, stains, and impact, making it ideal for renovations, events, and high-traffic areas. Keep floors in pristine condition with reliable, all-around protection.

Carpet Protection - Self-Adhering Transparent Film

Material: **PE - Polyethylene**
 Thickness: **80um (0.08mm)**



| Code | Width | Roll Length | Weight |
|-------------|-------|-------------|--------|
| CPFH0.5L100 | 0.5m | 100m | 3.5kg |
| CPFH1L100 | 1.0m | 100m | 7.0kg |
| CPFH1.2L100 | 1.2m | 100m | 8.4kg |



Our heavy-duty clear carpet film is a durable, transparent shield against dirt, spills, and stains. It adheres securely to carpeted surfaces, providing temporary protection without leaving residue. Perfect for construction, moving, or event setups, this film keeps carpets clean and protected from damage, while being easy to apply and remove.

Garden Essential Range

Weed Mat - Woven Fabric

Material: **PP - Polypropylene**

Weight: **100g/m²**

Feature: **UV Stabilised**



| Code | Width | Roll Length | Coverage | Weight |
|-----------|-------|-------------|-------------------|--------|
| WWH1L20 | 1.0m | 20m | 20m ² | 2.0kg |
| WWH1L100 | 1.0m | 100m | 100m ² | 10.0kg |
| WWH1.5L20 | 1.5m | 20m | 30m ² | 3.0kg |
| WWH1.5L50 | 1.5m | 50m | 75m ² | 7.5kg |
| WWH2L20 | 2.0m | 20m | 40m ² | 4.0kg |
| WWH2L50 | 2.0m | 50m | 100m ² | 10.0kg |



Our woven weed mat is crafted from interlaced fibers, creating a highly durable, tear-resistant barrier against weeds. UV-stabilized to withstand extended sun exposure, this mat allows water and nutrients to penetrate the soil while blocking weeds. It's ideal for high-traffic garden beds, walkways, and larger landscaping projects requiring strong weed control.

Weed Mat - Non-woven Fabric

Weight: **60g/m², 80g/m²**

Feature: **UV Stabilised**



| Code | Width | Roll Length | Coverage | Weight |
|-------------|-------|-------------|-------------------|--------------------|
| NWWH1L50-60 | 1.0m | 50m | 50m ² | 60g/m ² |
| NWWH2L50-60 | 2.0m | 50m | 100m ² | 60g/m ² |
| NWWH1L10-80 | 1.0m | 10m | 10m ² | 80g/m ² |
| NWWH1L25-80 | 1.0m | 25m | 25m ² | 80g/m ² |
| NWWH1L50-80 | 1.0m | 50m | 50m ² | 80g/m ² |
| NWWH2L25-80 | 2.0m | 25m | 50m ² | 80g/m ² |
| NWWH2L50-80 | 2.0m | 50m | 100m ² | 80g/m ² |



Made from a soft, breathable fabric, the non-woven weed mat is lightweight yet effective for lasting weed prevention. This UV-stabilized mat lets water and air reach the soil more freely, promoting plant health while deterring weeds. It's perfect for flower beds, vegetable gardens, and smaller landscaped areas where flexibility is essential.

Garden Essential Range

Geotextile Fabric - Non-woven Fabric

Material: **Polypropylene (PP)**

Feature: **UV Stabilised**

**Ideal for Civil, Drainage,
Landscaping Use**



| Code | Width | Roll Length | Coverage | Weight | Colour |
|----------|-------|-------------|-------------------|---------------------|--------|
| GFH2L50B | 2.0m | 50m | 100m ² | 145g/m ² | Black |
| GFH4L50B | 4.0m | 50m | 200m ² | 145g/m ² | Black |
| GFH2L50W | 2.0m | 50m | 100m ² | 145g/m ² | White |
| GFH4L50W | 4.0m | 50m | 200m ² | 145g/m ² | White |



The non-woven Geotextile fabric is a durable, needle-punched polypropylene layer designed for drainage and soil separation. It allows water to pass freely while preventing soil movement, making it ideal for driveways, retaining walls, and erosion-control areas. Suitable for both civil and landscaping projects requiring strong ground stabilisation.

Weed Mat Pin

Material: **Galvanised Steel**



| Code | Width | Length | Diameter |
|-----------|-------|--------|----------|
| SL363-130 | 30mm | 130mm | Ø2.8mm |
| SL363-230 | 30mm | 230mm | Ø2.8mm |

Our sturdy weed mat pins secure both woven and non-woven mats, keeping them in place even in windy conditions. Durable and easy to install, these pins ensure a stable, protected environment for garden and landscape applications.

Garden Edge System

Garden Edge Strip Profile

Material: **6063-T5 Aluminium**
 Feature: **Durable, Flexible**



GES80
80mm Height



GES100
100mm Height

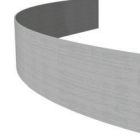

GES125
125mm Height

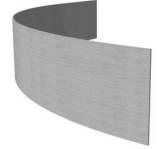

GES150
150mm Height



| Code | Height | Length | Weight |
|--------|--------|--------|----------|
| GES80 | 80mm | 5.97m | 0.68kg/m |
| GES100 | 100mm | 5.97m | 0.86kg/m |
| GES125 | 125mm | 5.97m | 1.07kg/m |
| GES150 | 150mm | 5.97m | 1.28kg/m |

Our Garden Edge Strips are made from premium-grade aluminium flat bars, offering outstanding strength and long-term durability. The material is both strong and flexible, allowing smooth forming into curves for clean, modern garden designs. Perfect for separating lawn, paths, and garden beds while maintaining a professional, crisp edge.

Garden Edge Clips & Pegs



GEC25
25mm Fixing Peg

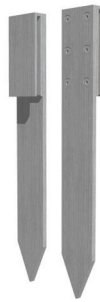

GEC40
40mm Joining Peg

Material: **6061-T6 Aluminium**
 Feature: **Durable, Easy Installation**

| Code | Width | Length |
|-------|-------|--------|
| GEC25 | 25mm | 300mm |
| GEC40 | 40mm | 300mm |



Our Garden Edge Clips and Pegs are made from high-strength 6061-T6 aluminium, providing excellent durability and long-term weather resistance. They allow quick and secure installation of edging strips, keeping them firmly in place even on uneven ground, and ensuring a clean, professional, and continuous edge finish for garden beds, lawns, and pathways.

Artificial Turf & Lawn Solutions

Golf Putting Turf

Material: **Polypropylene & Polythene**
 Sand Fill: **8-10kg/m²**



| Code | Pile Height | Width | Roll Length | Stitch Rate | Color |
|----------|-------------|-------|-------------|----------------|---------|
| AT12GOLF | 13mm | 3.7m | 20m | 230 Stitches/m | Emerald |



Our Golf Putting Turf provides a smooth, consistent surface ideal for golf practice and residential putting greens. The 13 mm short-pile design delivers excellent ball roll and natural response while maintaining durability and low maintenance. Suitable for both indoor and outdoor installations, it performs well under all weather conditions and resists fading under UV exposure.

Artificial Lawn Turf

Material: **Polypropylene & Polythene**
 Sand Fill: **8-10kg/m²**



AT30 - 30mm



AT35 - 35mm



AT40 - 40mm

| Code | Pile Height | Width | Roll Length | Stitch Rate | Color |
|------|-------------|-------|-------------|----------------|------------------------------------|
| AT30 | 30mm | 3.7m | 20m | 150 Stitches/m | Vine Cyan & Vine Green |
| AT35 | 35mm | 3.7m | 20m | 160 Stitches/m | Mint Green & Matt Olive |
| AT40 | 40mm | 3.7m | 20m | 130 Stitches/m | Amerson Olive & Dark Mineral Green |



Our Artificial Lawn Turf offers a lush, natural appearance with realistic texture and colour variation. Designed for gardens, playgrounds, and landscaping, it combines resilience with softness for everyday comfort. The UV-stabilised fibres ensure long-lasting colour, while the strong backing and drainage design allow easy installation on a variety of bases.

Artificial Turf & Lawn Solutions

Artificial Turf Accessories



SL436
Seaming Tape



SL434
Ground Fixing Nails



SL438
Turf Adhesive Part A



SL438
Turf Adhesive Part B

| Code | Product | Detail Spec | Package |
|---------|--------------------|---------------|-------------|
| SL-434 | Ground Fixing Nail | Ø4.5X125mm | 50 pcs |
| SL-435 | Ground Fixing Nail | Ø4.5X125mm | 100 pcs |
| SL-436 | Seaming Tape | 150mm Width | 5m Roll |
| SL-437 | Seaming Tape | 150mm Width | 10m Roll |
| SL-438A | Adhesive - Part A | Base Compound | Weight: 9kg |
| SL-438B | Adhesive - Part B | Hardener | Weight: 1kg |

Installation Guide

1. Clear existing grass and debris from the area.
2. Compact the ground and prepare a stable base using crushed gravel or sand.
3. Roll out the turf and allow it to relax for 30–60 minutes before cutting.
4. Trim edges and ensure all turf rolls face the same direction.
5. Join seams with Seaming Tape and Turf Adhesive (Part A + Part B, 9:1 mix).
6. Secure turf with Fixing Nails Ø4.5 × 125 mm, spaced 150–200 mm apart.
7. Evenly spread silica sand infill (8 – 10 kg/m²) across the surface.
8. Brush the fibres upright for a natural look and smooth finish.



Roof Fall Safety Mesh Range

Commercial Roof Safety Mesh Roof Underlay Support

Material: **HT Galvanised Steel Wire**
Wire Dia.: **Ø2.0mm**
Aperture: **300x150mm**

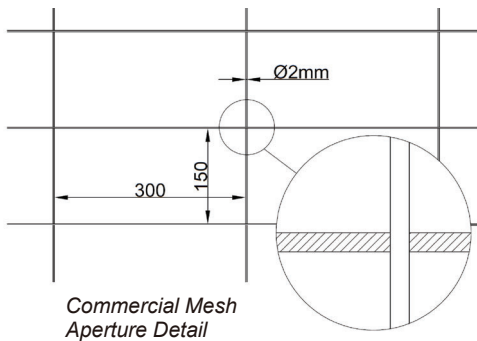
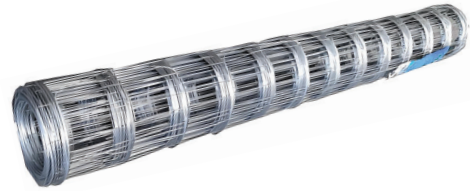

| Code | Width | Roll Length | Coverage | Weight |
|--------------|-------|-------------|---------------------|--------|
| CRSMW1.8L50 | 1.8m | 50m | 90m ² | 23.5kg |
| CRSMW2.25L50 | 2.25m | 50m | 112.5m ² | 29.0kg |



Our Commercial Roof Safety Mesh is made from 2.0mm high-tensile galvanized steel wire with a 300x150mm mesh aperture, this heavy-duty mesh provides strong fall protection for commercial and industrial roofing applications, ensuring safety and compliance.

Residential Roof Safety Mesh Roof Underlay Support

Material: **High Tensile Galvanised Wire**
Wire Dia.: **Ø1.0mm**
Aperture: **50mm / 75mm**

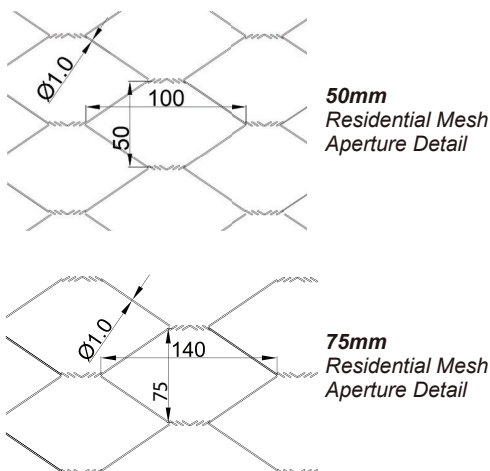

| Code | Width | Roll Length | Aperture | Weight |
|--------------|-------|-------------|----------|--------|
| RRSMW2L50-50 | 2.0m | 50m | 50mm | 30.2kg |
| RRSMW2L50-75 | 2.0m | 50m | 75mm | 21.2kg |

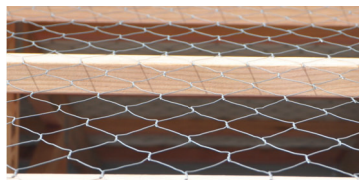

Our Residential Roof Safety Mesh is designed for home installations, this mesh features 1.0mm high-tensile galvanized wire with 50mm or 75mm hexagonal mesh options, offering lightweight yet durable support for residential roofing safety and insulation retention.

Fence Mesh Solutions

Chainlink Fence Mesh

Material: **Galvanised Steel**
 Wire Diameter: **Ø2.5mm**
 Mesh Aperture: **50x50mm**

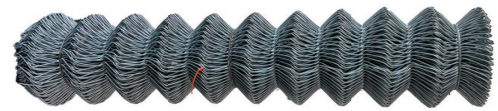

| Code | Height | Length | Color | Weight |
|-----------|--------|--------|------------|--------|
| CFH0.9L10 | 0.9m | 10m | Galv Steel | 14.0kg |
| CFH0.9L20 | 0.9m | 20m | Galv Steel | 30.0kg |
| CFH1.2L10 | 1.2m | 10m | Galv Steel | 18.7kg |
| CFH1.5L10 | 1.5m | 10m | Galv Steel | 23.5kg |
| CFH1.8L10 | 1.8m | 10m | Galv Steel | 28.0kg |
| CFH1.8L20 | 1.8m | 20m | Galv Steel | 56.0kg |
| CFH2.1L20 | 2.1m | 20m | Galv Steel | 65.5kg |
| CFH2.4L20 | 2.4m | 20m | Galv Steel | 75.0kg |



Our chainlink fence mesh is a versatile and durable option for securing property boundaries, made from galvanized steel to resist rust and withstand harsh conditions. Available in a range of heights, this mesh is ideal for residential, commercial, and industrial applications, offering strong and reliable perimeter protection with easy installation.

Chainlink Fence Mesh

Material: **Green PVC Coated**
 Wire Diameter: **Ø3.0mm**
 Mesh Aperture: **50x50mm**

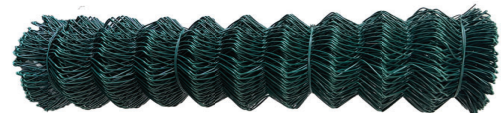

| Code | Height | Length | Color | Weight |
|--------------|--------|--------|-----------|--------|
| CFH0.9L20PVC | 0.9m | 20m | Green PVC | 25.0kg |
| CFH1.2L20PVC | 1.2m | 20m | Green PVC | 33.0kg |
| CFH1.5L20PVC | 1.5m | 20m | Green PVC | 41.7kg |
| CFH1.8L20PVC | 1.8m | 20m | Green PVC | 50.0kg |



Our chainlink fence mesh is a versatile and durable option for securing property boundaries, made from galvanized steel to resist rust and withstand harsh conditions. Available in a range of heights, this mesh is ideal for residential, commercial, and industrial applications, offering strong and reliable perimeter protection with easy installation.

Fence Mesh Solutions

Sheep Fence Mesh

Material: **Galvanised Steel**
 Wire Diameter: Vertical - **Ø1.8**
 Horizontal - **Ø2.0mm**
 Aperture: **300x150mm**



| Code | Height | Length | Weight |
|------------|--------|--------|--------|
| FSFH0.9L50 | 0.9m | 50m | 15.4kg |
| FSFH1.2L50 | 1.2m | 50m | 23.5kg |
| FSFH1.5L50 | 1.5m | 50m | 26.0kg |
| FSFH1.9L50 | 1.9m | 50m | 31.0kg |



Designed specifically for livestock enclosures, our sheep fence mesh provides a safe and sturdy barrier, with a close-knit design that prevents animal escapes. Available in various heights, this galvanized mesh is built to endure rugged environments and resist rust, making it an excellent choice for farms and rural properties needing secure, long-lasting fencing.

Hex Fence Mesh

Material: **Galvanised Steel**
 Wire Diameter: **Ø0.9mm**
 Aperture: **50x50mm**

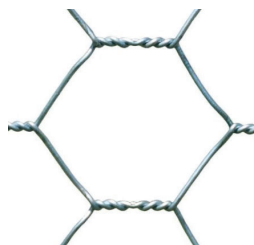
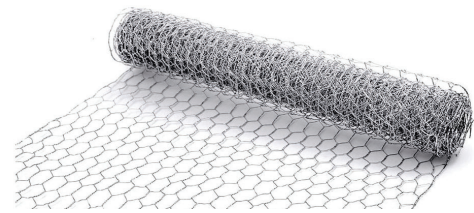

| Code | Height | Length | Weight |
|-----------|--------|--------|--------|
| HFH0.9L50 | 0.9m | 50m | 11.5kg |
| HFH1.2L50 | 1.2m | 50m | 15.5kg |
| HFH1.5L50 | 1.5m | 50m | 19.5kg |
| HFH1.8L50 | 1.8m | 50m | 23.0kg |
| HFH2L50 | 2.0m | 50m | 25.5kg |

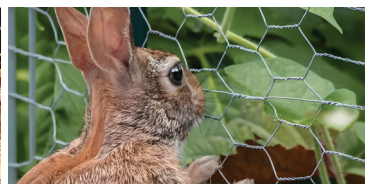

Our hex wire fence mesh, crafted from galvanized steel, provides durable, rust-resistant containment for gardens, chicken coops, and animal enclosures. With a strong, flexible hexagonal design, it's available in a range of heights, ensuring easy installation, reliable strength, and lasting outdoor protection for various projects and settings.

Fence Mesh Solutions

Square Welded Fence Mesh

Material: **Galvanised Steel**
 Wire Diameter: **Ø0.9mm**
 Aperture: **25x25mm**

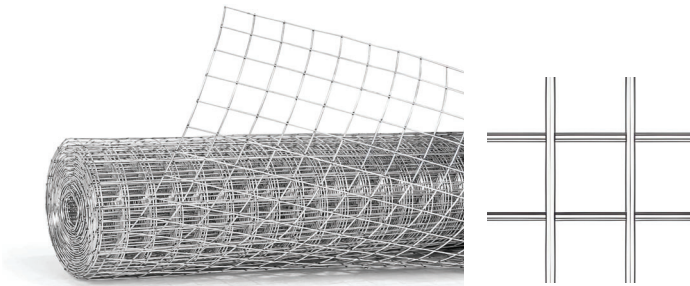
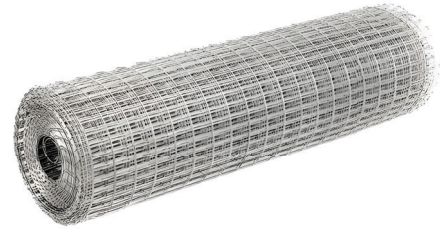

| Code | Height | Length | Weight |
|-------------|--------|--------|--------|
| SWWFH0.9L10 | 0.9m | 10m | 18.5kg |
| SWWFH1.2L10 | 1.2m | 10m | 24.5kg |



Our square welded fence mesh, crafted from galvanized steel, offers durable, rust-resistant protection ideal for gardens, property boundaries, and animal enclosures. With a strong, welded square design, this mesh provides resilience in outdoor settings. Available in various heights, it's easy to install, ensuring secure, long-lasting containment for a range of applications.

Euro Fence Mesh

Material: **PVC Coated Galvanised Steel**
 Wire Diameter: **Ø2.4mm**
 Aperture: **60x60mm**

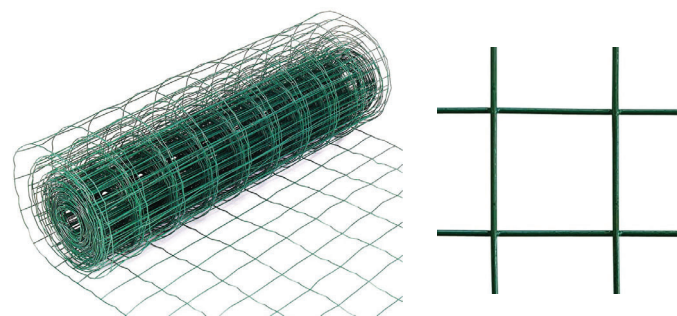
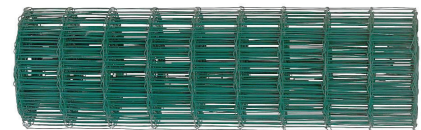

| Code | Height | Length | Weight |
|------------|--------|--------|--------|
| EHFH1.2L30 | 1.2m | 30m | 13.5kg |
| EHFH1.5L30 | 1.5m | 30m | 14.5kg |
| EHFH1.8L30 | 1.8m | 30m | 17.5kg |

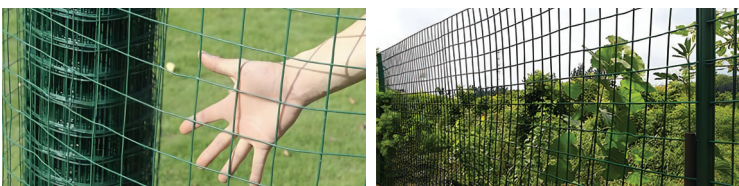

Our Euro fence mesh, also known as Holland fence mesh, is made from galvanized steel for strength and rust resistance. Ideal for various applications, it provides reliable security for gardens, livestock, and commercial properties. Available in multiple heights, this mesh offers easy installation and an attractive look, making it a popular choice for durable fencing.

Fence Mesh Solutions

Orange Safety Fence Mesh

Material: **HDPE - High Density Polyethylene**

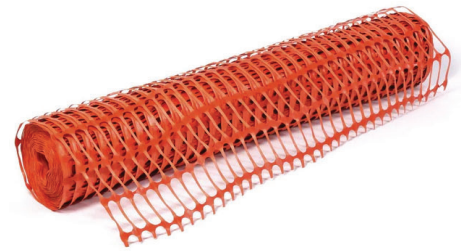

| Code | Height | Length | Aperture | Weight |
|---------------|--------|--------|----------|--------|
| SMW1L50RED4.5 | 1m | 50m | 65x35mm | 4.5kg |
| SMW1L50RED | 1m | 50m | 75x40mm | 8.0kg |



Our orange safety fence mesh is a durable, high-visibility barrier ideal for construction sites, events, and hazard areas. Made from weather-resistant plastic, it's lightweight, strong, easy to install, and reusable. The bright orange color ensures visibility for effective safety and crowd control in temporary or long-term use.

Orange Cable Tie

Material: **Nylon 6/6**

Feature: **UV Stabilised**

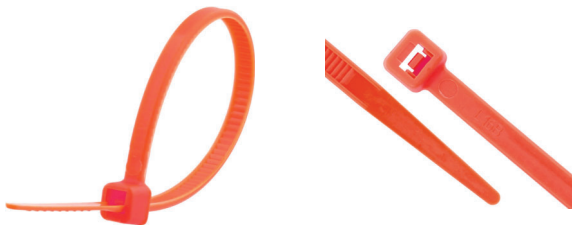

| Code | Width | Length | Package | Weight |
|------|-------|--------|---------|--------|
| OPCT | 3.6mm | 200mm | 100pcs | 4.5kg |



Our durable cable ties are made from UV-resistant nylon, ideal for securing safety fence mesh outdoors. With strong tensile strength, they hold the mesh securely in place, ensuring a reliable, easy-to-use solution for fastening. Available in various lengths to simplify fence installation.

Fence Wire Solutions

Fence Wire - High Tensile

Material: Galvanised Steel



| Code | Wire Dia. | Length | Breaking Load | Weight |
|--------------|-----------|--------|---------------|--------|
| FW1.6L100HT | Ø1.6mm | 100m | 220kg | 1.6kg |
| FW2L100HT | Ø2.0mm | 100m | 395kg | 2.5kg |
| FW2.5L100HT | Ø2.5mm | 100m | 620kg | 4.0kg |
| FW2.5L650HT | Ø2.5mm | 650m | 620kg | 25.0kg |
| FW3.15L100HT | Ø3.15mm | 100m | 835kg | 6.3kg |
| FW3.15L400HT | Ø3.15mm | 400m | 835kg | 25.0kg |



Constructed from high-tensile galvanised steel wire, designed for superior strength and durability in fencing applications. Its enhanced tensile properties maintain tension over long distances, reducing sagging and ensuring reliable performance. Ideal for agricultural fencing and boundary lines.

Fence Wire - Standard

Material: Galvanised Steel



| Code | Wire Dia. | Length | Weight |
|----------------|-----------|--------|--------|
| FWGALV1.6 | Ø1.6mm | 63m | 1.0kg |
| FW1.6L100GALV | Ø1.6mm | 100m | 2.0kg |
| FWGALV2 | Ø2.0mm | 40m | 1.0kg |
| FW2.0L100GALV | Ø2.0mm | 100m | 2.5kg |
| FW2.5L100GALV | Ø2.5mm | 100m | 4.0kg |
| FW2.5L650GALV | Ø2.5mm | 650m | 25.0kg |
| FW3.15L400GALV | Ø3.15mm | 400m | 25.0kg |



Constructed from galvanised steel wire, offering reliable strength and corrosion resistance for general fencing applications. Its balanced flexibility allows for easy handling and installation while maintaining consistent performance. Ideal for residential fencing, garden use, and light-duty boundary applications.

Fence Wire Solutions

Razor Fence Wire - Concertina Coiled

Material: **Galvanised Steel**
 Razor Size: **22x15mm**
 Razor Distance: **34mm**

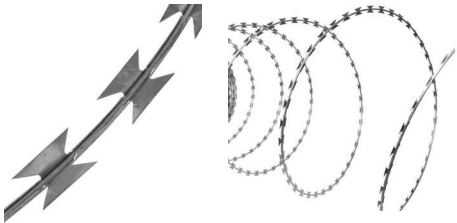

| Code | Coil Dia. | Wire Dia. | Stretched Length | Coiled Length | Weight |
|---------------|-----------|-----------|------------------|---------------|--------|
| BFWGALV30L60 | Ø30cm | Ø1.6mm | 60m | 17-20m | 5.5kg |
| BFGALV45L5 | Ø45cm | Ø1.6mm | 5m | 1-2m | 5.0kg |
| BFWGALV45L100 | Ø45cm | Ø1.6mm | 100m | 25-30m | 9.0kg |
| BFWGALV70L150 | Ø70cm | Ø1.6mm | 150m | 17-20m | 12.0kg |



Constructed from galvanized steel with sharp 22x15mm blades at 34mm intervals, our pre-coiled razor wire attaches easily to fence tops. Its helical shape enhances perimeter security, making it perfect for strong, visible deterrence. Available in multiple lengths for convenient, durable installation.

Razor Fence Wire - Flat Wrap

Material: **Galvanised Steel**
 Razor Size: **22x15mm**
 Razor Distance: **34mm**

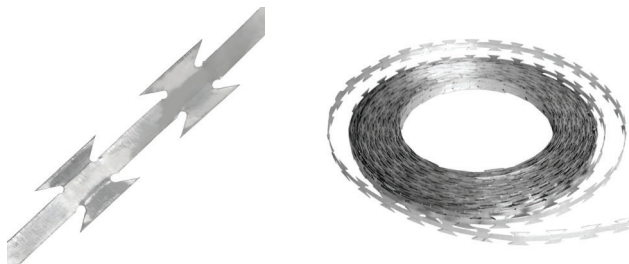
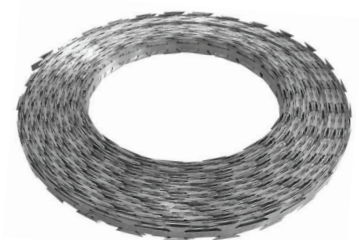

| Code | Coil Dia. | Length | Weight |
|---------------|-----------|--------|--------|
| BFWGALV35L11F | Ø35cm | 11m | 10.0kg |
| BFWGALV50L10F | Ø50cm | 10m | 10.0kg |



Our flat wrap razor wire, made of durable galvanized steel, has 22x15mm blades spaced 34mm apart. Flexible and easy to shape, it fits a variety of fencing projects, providing discreet yet high-level security. Available in various lengths, it's ideal for adaptable perimeter protection.

Fence Wire Solutions

Barbed Fence Wire

Material: **Galvanised Steel**
Sting Distance: **100mm**

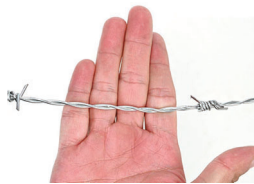

| Code | Wire Dia. | Length | Weight |
|-----------------|-----------|--------|--------|
| SBFWGALV1.6 | Ø1.6mm | 100m | 5.0kg |
| SBFWGALV1.6L400 | Ø1.6mm | 100m | 5.0kg |
| SBFWGALV2.2 | Ø2.2mm | 50m | 5.0kg |
| SBFWGALV2.5 | Ø2.5mm | 250m | 31.5kg |

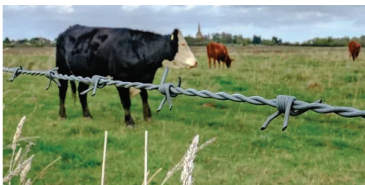

Our barbed fence wire, crafted from rust-resistant galvanized steel, offers reliable, long-lasting security with barbs spaced every 100mm for enhanced deterrence. Available in lengths of 50m, 100m, and 250m, it's ideal for securing farms, property boundaries, and livestock enclosures, providing both strength and easy installation.

Galvanised Steel Post Range

Round Hollow Post - In-ground

Material: Galvanised Steel

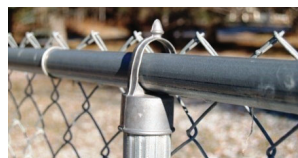
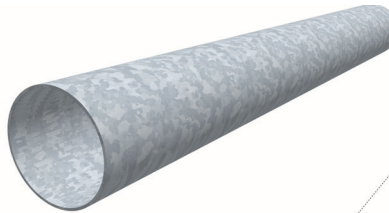

Our round galvanised posts are durable, versatile, and available in multiple sizes and lengths to suit diverse fencing needs. Designed for in-ground installation, they're ideal for rural and commercial applications. The galvanised coating offers strong rust resistance, ensuring a reliable, long-lasting fence solution.

| Code | Diameter | Thickness | Length |
|-----------------|----------|-----------|--------|
| GSB50T3L1.5 | Ø50mm | 3.00mm | 1.5m |
| GSB50T3L2 | Ø50mm | 3.00mm | 2.0m |
| GSB50T3L2.5 | Ø50mm | 3.00mm | 2.5m |
| GSB50T3L3 | Ø50mm | 3.00mm | 3.0m |
| GSB60T3.5L1.5 | Ø60mm | 3.50mm | 1.5m |
| GSB60T3.5L2 | Ø60mm | 3.50mm | 2.0m |
| GSB60T3.5L2.5 | Ø60mm | 3.50mm | 2.5m |
| GSB60T3.5L3 | Ø60mm | 3.50mm | 3.0m |
| GSB76T3.5L1.5 | Ø76mm | 3.50mm | 1.5m |
| GSB76T3.5L2 | Ø76mm | 3.50mm | 2.0m |
| GSB76T3.5L2.5 | Ø76mm | 3.50mm | 2.5m |
| GSB76T3.5L3 | Ø76mm | 3.50mm | 3.0m |
| GSB114T3.25L1.5 | Ø114mm | 3.25mm | 1.5m |
| GSB114T3.25L2 | Ø114mm | 3.25mm | 2.0m |
| GSB114T3.25L2.5 | Ø114mm | 3.25mm | 2.5m |
| GSB114T3.25L3 | Ø114mm | 3.25mm | 3.0m |
| GSB165T3.5L1.5 | Ø165mm | 3.50mm | 1.5m |
| GSB165T3.5L2 | Ø165mm | 3.50mm | 2.0m |
| GSB165T3.5L2.5 | Ø165mm | 3.50mm | 2.5m |
| GSB165T3.5L3 | Ø165mm | 3.50mm | 3.0m |

Square Hollow Post - In-ground

Material: Galvanised Steel

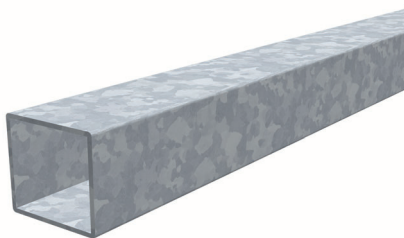

Square galvanised posts offer strength and a modern look for fencing. Available in various sizes and lengths, they are ideal for rural and commercial, in-ground use. The galvanised finish adds durability, resisting corrosion and wear over time. These posts provide a stable, lasting framework for any fencing style.

| Code | Size | Thickness | Length |
|---------------|-----------|-----------|--------|
| FF50T2L1.5 | 50x50mm | 2.00mm | 1.5m |
| FF50T2L2 | 50x50mm | 2.00mm | 2.0m |
| FF50T2L2.5 | 50x50mm | 2.00mm | 2.5m |
| FF65T2.75L1.5 | 65x65mm | 2.75mm | 1.5m |
| FF65T2.75L2 | 65x65mm | 2.75mm | 2.0m |
| FF65T2.75L2.5 | 65x65mm | 2.75mm | 2.5m |
| FF65T2.75L3 | 65x65mm | 2.75mm | 3.0m |
| FF75T3L1.5 | 75x75mm | 3.00mm | 1.5m |
| FF75T3L2 | 75x75mm | 3.00mm | 2.0m |
| FF75T3L2.5 | 75x75mm | 3.00mm | 2.5m |
| FF75T3L3 | 75x75mm | 3.00mm | 3.0m |
| FF100T3L1.5 | 100x100mm | 3.00mm | 1.5m |
| FF100T3L2 | 100x100mm | 3.00mm | 2.0m |
| FF100T3L2.5 | 100x100mm | 3.00mm | 2.5m |
| FF100T3L3 | 100x100mm | 3.00mm | 3.0m |

Y-Post & Accessory Range

Y-Post - Waratah Post

Material: **Black Tar Coated Steel**

Weight: **1.80kg/m approx.**

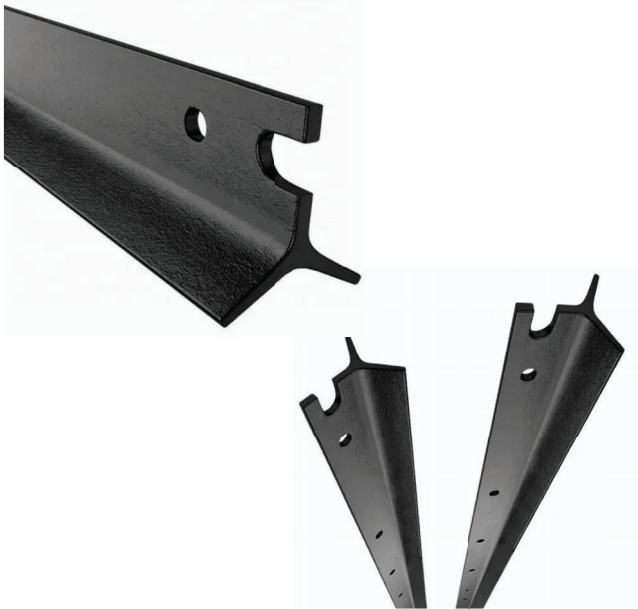

| Code | Length | Holes | Weight |
|----------|--------|-------|--------|
| SYP0.45M | 0.45m | 2 | 0.81kg |
| SYP0.6M | 0.6m | 3 | 1.08kg |
| SYP0.8M | 0.8m | 5 | 1.44kg |
| SYP0.9M | 0.9m | 5 | 1.62kg |
| SYP1.2M | 1.2m | 11 | 2.16kg |
| SYP1.35M | 1.35m | 11 | 2.43kg |
| SYP1.5M | 1.5m | 14 | 2.70kg |
| SYP1.65M | 1.65m | 14 | 2.97kg |
| SYP1.8M | 1.8m | 14 | 3.24kg |
| SYP2.4M | 2.4m | 17 | 4.32kg |
| SYP2.7M | 2.7m | 17 | 4.86kg |
| SYP3M | 3.0m | 17 | 5.40kg |



Our Y-post, known as a Waratah post, is designed for strength and stability in fencing. Made from galvanized steel, this post resists rust and corrosion, ensuring durability. Its Y-shaped design provides support and easy installation for wire or mesh fencing, making it ideal for agricultural use. Available in multiple heights to meet fencing needs.

Y-Post End Cap

Material: **HDPE - High Density Polyethylene**

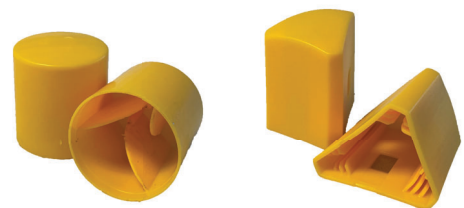

| Code | Shape | Weight |
|-------|----------|--------|
| SL-20 | Round | 24.3g |
| SL-21 | Triangle | 17.6g |

Our Y-post yellow safety cap enhances visibility and safety for Y-posts. Made from durable plastic, this cap fits onto the post, providing bright yellow color that helps prevent injury. This addition protects the post from debris while ensuring the installation is noticeable, promoting safety in agricultural settings.

Tie Wire Range

Tie Wire

Material: **Galvanised Steel Wire**



| Code | Wire Dia. | Length | Color | Weight |
|-----------------|-----------|--------|------------|--------|
| FTW0.7L50GALV | Ø0.7mm | 50m | Galv Steel | 0.20kg |
| FTW0.7L100GALV | Ø0.7mm | 100m | Galv Steel | 0.40kg |
| FTW0.9L50GALV | Ø0.9mm | 50m | Galv Steel | 0.25kg |
| FTW0.9L100GALV | Ø0.9mm | 100m | Galv Steel | 0.50kg |
| FTW1.25L50GALV | Ø1.25mm | 50m | Galv Steel | 0.55kg |
| FTW1.25L100GALV | Ø1.25mm | 100m | Galv Steel | 1.10kg |
| FTW1.6L50GALV | Ø1.6mm | 50m | Galv Steel | 1.00kg |
| FTW1.6L100GALV | Ø1.6mm | 100m | Galv Steel | 2.00kg |

Tie Wire - PVC Coated

Material: **PVC Coated Galvanised Steel Wire**

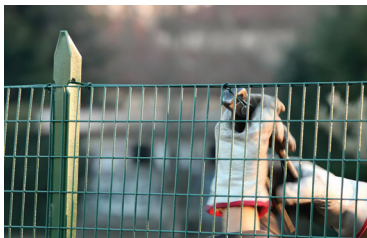

| Code | Wire Dia. | Length | Color | Weight |
|-----------|---------------------------|--------|-----------|--------|
| FTW2L50G | Wire Ø1.6mm Coated Ø2.0mm | 50m | Green PVC | 1.0kg |
| FTW2L100G | Wire Ø1.6mm Coated Ø2.0mm | 100m | Green PVC | 2.0kg |
| FTW2L50B | Wire Ø1.6mm Coated Ø2.0mm | 50m | Black PVC | 1.0kg |
| FTW2L100B | Wire Ø1.6mm Coated Ø2.0mm | 100m | Black PVC | 2.0kg |

Our Y-post yellow safety cap enhances visibility and safety for Y-posts. Made from durable plastic, this cap fits onto the post, providing bright yellow color that helps prevent injury. This addition protects the post from debris while ensuring the installation is noticeable, promoting safety in agricultural settings.

Fence & Mesh Range Tools & Accessories

Accessories & Tools



SL-368
Single Clip-lock
Wire Strainer



SL-367
Double Clip-lock
Wire Strainer



SL-369
Standard
Wire Strainer



SL-413
Clip-lock Wire Strainer
Ratchet Handle



SL-46
Chain-drive
Mesh Strainer



SL-45
Post Rammer

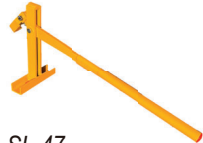

SL-47
Post Lifter



SL-410
Mesh & Cage Plier



SL-411
Plier Nail
(600pcs)

| Code | Description | Weight |
|--------|--------------------------------|--------|
| SL-368 | Single Clip-lock Wire Strainer | 1.35kg |
| SL-367 | Double Clip-lock Wire Strainer | 1.38kg |
| SL-369 | Standard Wire Strainer | 1.38kg |
| SL-413 | Wire Strainer Ratchet Handle | 0.50kg |
| SL-410 | Cage & Mesh Plier | 0.33kg |
| SL-411 | Plier Nails (600pcs/pack) | 0.31kg |
| SL-46 | Chain Mesh Strainer | 3.41kg |
| SL-45 | Post Rammer | 6.50kg |
| SL-47 | Post Lifter | 6.03kg |



Our Rural Fence Accessories make fencing easy and efficient. From wire strainers and ratchet handles for secure tensioning to pliers, post rammers, and lifters for hassle-free installation and repairs, we've got the tools you need for a durable, well-maintained fence.

Temporary Fencing System

Temporary Fence Panel

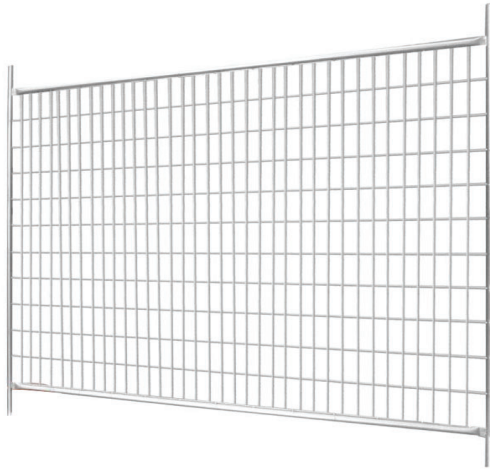

Finish: 14 Micron galvanized steel finish
 Mesh: 150mm X 60mm mesh spacing
 2.5mm thickness wire mesh

| Product Code | Panel Size |
|--------------|---------------------|
| TFSH2.1L2.4 | 2.4m (W) X 2.1m (H) |

Hot-dip galvanisation for maximum corrosion protection in harsh environments.
 Primarily used for Civil Construction Projects, Sport Events and Environmental Protection applications.

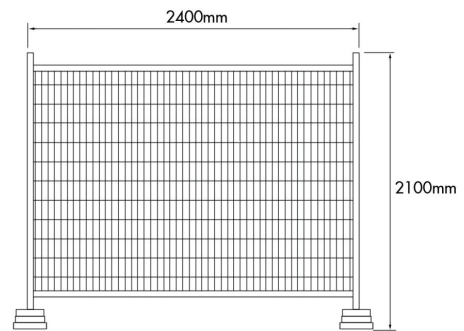

Temporary Fence Accessories



SL-71
Concrete Filled Foot



SL-72
Panel Clamp

| Product Code | Description |
|--------------|----------------------|
| SL-71 | Concrete Filled Foot |
| SL-72 | Panel Clamp |
| TFBH2.1L1.8 | Panel Bracing |



TFBH2.1L1.8
1.8m Height Panel Bracing





ALUMINIUM

Contact Us Now!

Auckland Rosedale Branch

Address: 6 John Glenn Ave, Rosedale,
Auckland 0632

Email: info.albany@sdalu.co.nz

Phone: 09 - 218 2188
09 - 218 2111

Auckland Manukau Branch

Address: 28 Ryan Pl, Manukau City,
Auckland 2104

Email: info.manukau@sdalu.co.nz

Phone: 09 - 217 8666

Christchurch Wigram Branch

Address: 67 Vickers Rd, Wigram,
Christchurch 8042

Email: info.chch@sdalu.co.nz

Phone: 03 - 366 6669

Follow Us on Social Media

