



SD Aluminium Comprehensive Product Catalogue



*A wide range of selections and high-quality materials
All supported by extensive local stock.*

May 2024 Edition



Your premier source for
top-quality standard aluminium extrusions & sheets
with expertise in tailor-made custom extrusions as well

Auckland Rosedale Branch

Address: 6 John Glenn Ave, Rosedale, Auckland 0632

Phone: 09-218 2188, 09-218 2111

Email: info@sdalu.co.nz

Auckland Manukau Branch

Address: 26 Lambie Dr, Papatoetoe, Auckland 2104

Phone: 09-218 2188, 09-218 2111

Email: info@sdalu.co.nz



About Us ...

SD Aluminium Ltd is a 100% New Zealand owned company. Founded in Albany, Auckland, with over 20 years' experiences in manufacturing and trading, SD Aluminium manufactures, produces and distributes premium aluminium extrusions, aluminium doors as well as customized aluminium extrusions, finishes, and fabrication coatings.

Their highly-skilled team has worked on a range of projects in many different industries, covering everything from aluminium extrusions for windows, doors, gates and fences, through to greenhouses, glass support, scaffolding and industrial assembly lines.

With their sophisticated production equipment, strong technical forces, advanced production management system and commitment to perfect customer service, you can trust them to deliver the highest quality solutions at competitive prices.

Business Advantage

01 Locally Based

SD Aluminium LTD is based right here in Auckland, New Zealand. They know the local market inside out and are only a phone call away.

02 Specialist design support

SD Aluminium's team of highly experienced engineers can assist with every stage of your project, from design and prototyping, through to production and installation.

03 Extensive Inventory

SD Aluminium provide a wide range of aluminium products, resulting in a large inventory with hundreds of different kinds suited for projects in the construction, marine and transport industries and more.

04 Fast Delivery

With our own delivery team, we can quick respond for your order request. From choosing and packaging you just need to call us and we will deliver your shipment as soon as possible.

Aluminium

Geometric Shape & Standard Profiles



| | | |
|---------------------------------------|-------|----------|
| <i>Square Hollows</i> | _____ | 1 - 4 |
| <i>Rectangular Hollows</i> | _____ | 5 - 10 |
| <i>Round Tubes</i> | _____ | 11 - 25 |
| <i>Equal Angles</i> | _____ | 26 - 27 |
| <i>Unequal Angles</i> | _____ | 28 - 30 |
| <i>U Channels</i> | _____ | 31 - 34 |
| <i>Flat Bars</i> | _____ | 35 - 39 |
| <i>Tee Bars</i> | _____ | 40 |
| <i>Solid Rod</i> | _____ | 41 - 42 |
| <i>Solid Square</i> | _____ | 43 |
| <i>Flat Sheet</i> | _____ | 44 - 45 |
| <i>Plate & Panel</i> | _____ | 46 |
| <i>Powdercoated Profiles</i> | _____ | 47 - 49 |
| <i>Fence Systems</i> | _____ | 50 - 54 |
| <i>Pre-punched Extrusions</i> | _____ | 55 - 59 |
| <i>Louvre Systems</i> | _____ | 60 - 62 |
| <i>Canopy Systems</i> | _____ | 63 - 68 |
| <i>Wardrobe & Kitchen Systems</i> | _____ | 69 - 70 |
| <i>Security Systems</i> | _____ | 71 - 72 |
| <i>Window & Door Systems</i> | _____ | 73 - 76 |
| <i>T-Slot Systems</i> | _____ | 77 - 80 |
| <i>Mouldings & Tracks</i> | _____ | 81 |
| <i>Y-Posts & Farm Fences</i> | _____ | 82 |
| <i>Temporary Fence Systems</i> | _____ | 83 |
| <i>Accessories</i> | _____ | 84 |
| <i>Screws</i> | _____ | 85 - 87 |
| <i>Galvanised Steel Extrusions</i> | _____ | 88 - 92 |
| <i>Technical Data Sheet</i> | _____ | 93 - 100 |



"✓" Stocked Item
 "✱" Pre-order Only Item
 (30-40 working days delivery)



Square Hollow

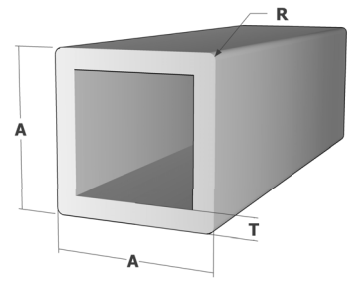

| Product Code | Ex Stock | A (mm) | T (mm) | R (mm) | Mass (kg/m) | Perimeter (mm) | Area (mm ²) |
|-----------------|----------|--------|--------|--------|-------------|----------------|-------------------------|
| SHA10T1 | ✱ | 10.0 | 1.0 | | 0.103 | 40.00 | 36.00 |
| SHA12T1 | ✓ | 12.0 | 1.0 | | 0.125 | 48.00 | 44.00 |
| SHA15T1 | ✱ | 15.0 | 1.0 | | 0.160 | 60.00 | 56.00 |
| SHRA15T1R1.5 | ✱ | 15.0 | 1.0 | 1.5 | 0.150 | 55.83 | 52.49 |
| SHA15T1.2 | ✱ | 15.0 | 1.2 | | 0.189 | 60.00 | 66.24 |
| SHA15T1.5 | ✓ | 15.0 | 1.5 | | 0.231 | 60.00 | 81.14 |
| SHA16T1.3 | ✓ | 16.0 | 1.3 | | 0.218 | 64.00 | 76.44 |
| SHRA16T1.8R2.8 | ✱ | 16.0 | 1.8 | 2.8 | 0.314 | 58.85 | 110.00 |
| SHA18T1.2 | ✱ | 18.0 | 1.2 | | 0.230 | 72.00 | 80.64 |
| SHA18T2.2 | ✓ | 18.0 | 2.2 | | 0.396 | 72.00 | 139.00 |
| SHRA18.7T1.3R6 | ✱ | 18.7 | 1.3 | 6.0 | 0.224 | 64.50 | 78.54 |
| SHRA18.8T1.35R6 | ✱ | 18.8 | 1.35 | 6.0 | 0.233 | 64.90 | 81.89 |
| SHA19T0.8 | ✱ | 19.0 | 0.8 | | 0.166 | 76.00 | 58.40 |
| SHA19T1 | ✱ | 19.0 | 1.0 | | 0.205 | 76.00 | 72.00 |
| SHA19T1.2 | ✓ | 19.0 | 1.2 | | 0.244 | 76.00 | 85.44 |
| SHRA19T1.2R2 | ✓ | 19.0 | 1.2 | 2.0 | 0.235 | 72.57 | 82.56 |
| SHA19T1.6 | ✓ | 19.0 | 1.6 | | 0.317 | 75.14 | 113.36 |
| SHRA19T1.6R2 | ✓ | 19.0 | 1.6 | 2.0 | 0.317 | 72.60 | 108.14 |
| SHRA19T2R2 | ✓ | 19.0 | 2.0 | 2.0 | 0.378 | 72.60 | 132.64 |
| SHA20T0.55 | ✱ | 20.0 | 0.55 | | 0.122 | 80.00 | 42.79 |
| SHA20T0.7 | ✱ | 20.0 | 0.7 | | 0.154 | 80.00 | 54.00 |
| SHA20T1.2 | ✓ | 20.0 | 1.2 | | 0.257 | 80.00 | 90.24 |
| SHRA20T1.6R2 | ✱ | 20.0 | 1.6 | 2.0 | 0.326 | 76.57 | 114.46 |
| SHRA20T1.8R2 | ✱ | 20.0 | 1.8 | 2.0 | 0.364 | 76.57 | 127.70 |
| SHRA20T1.9R1 | ✱ | 20.0 | 1.9 | 1.0 | 0.390 | 78.28 | 136.80 |
| SHA20T2 | ✓ | 20.0 | 2.0 | | 0.410 | 80.00 | 144.00 |
| SHA20T3 | ✓ | 20.0 | 3.0 | | 0.581 | 79.49 | 204.00 |
| SHRA21T1.8R2.8 | ✱ | 21.0 | 1.8 | 2.8 | 0.418 | 79.30 | 146.52 |
| SHA22T0.75 | ✱ | 22.0 | 0.75 | | 0.182 | 87.00 | 63.75 |
| SHRA22T1.1 | ✱ | 22.0 | 1.1 | | 0.262 | 87.50 | 91.96 |
| SHRA23T2R2.5 | ✱ | 23.0 | 2.0 | 2.5 | 0.464 | 87.70 | 162.71 |
| SHRA23.8T10.9R1 | ✱ | 23.8 | 10.9 | 1.0 | 0.186 | 6.54 | 65.40 |
| SHA24.8T1.5 | ✱ | 24.8 | 1.5 | | 0.398 | 98.69 | 139.80 |
| SHA24.8T1.8 | ✱ | 24.8 | 1.8 | | 0.472 | 98.68 | 165.60 |
| SHA25T0.6 | ✱ | 25.0 | 0.6 | | 0.167 | 99.49 | 58.56 |
| SHA25T0.8 | ✱ | 25.0 | 0.8 | | 0.207 | 99.49 | 72.67 |
| SHA25T1 | ✱ | 25.0 | 1.0 | | 0.274 | 99.50 | 96.00 |
| SHA25T1.2 | ✓ | 25.0 | 1.2 | | 0.326 | 100.00 | 114.24 |
| SHRA25T1.2R2 | ✓ | 25.0 | 1.2 | 2.0 | 0.317 | 96.57 | 111.36 |
| SHA25T1.5 | ✱ | 25.0 | 1.5 | | 0.402 | 100.00 | 141.00 |

"✓" Stocked Item
 "✱" Pre-order Only Item
 (30-40 working days delivery)



Square Hollow

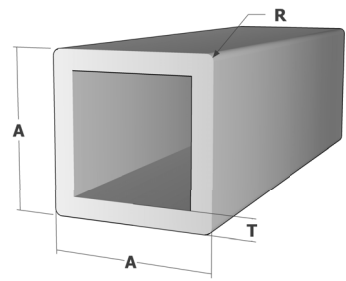

| Product Code | Ex Stock | A (mm) | T (mm) | R (mm) | Mass (kg/m) | Perimeter (mm) | Area (mm ²) |
|------------------|----------|--------|--------|--------|-------------|----------------|-------------------------|
| SHRA25T1.5R2 | ✓ | 25.0 | 1.5 | 2.0 | 0.393 | 96.60 | 137.80 |
| SHRA25T1.8R2 | ✱ | 25.0 | 1.8 | 2.0 | 0.463 | 95.80 | 162.30 |
| SHA25T2 | ✓ | 25.0 | 2.0 | | 0.524 | 100.00 | 184.00 |
| SHRA25T2R2 | ✱ | 25.0 | 2.0 | 2.0 | 0.510 | 95.76 | 179.00 |
| SHRA25T2R3 | ✓ | 25.0 | 2.0 | 3.0 | 0.505 | 94.85 | 177.13 |
| SHRA25T2.5R2 | ✱ | 25.0 | 2.5 | 2.0 | 0.626 | 95.76 | 219.60 |
| SHRA25T3R3 | ✓ | 25.0 | 3.0 | 3.0 | 0.731 | 94.85 | 256.35 |
| SHA25T3 | ✓ | 25.0 | 3.0 | | 0.752 | 100.00 | 264.00 |
| SHA25.4T0.9 | ✱ | 25.4 | 0.9 | | 0.251 | 101.10 | 88.20 |
| SHA28T2 | ✱ | 28.0 | 2.0 | | 0.593 | 111.50 | 207.92 |
| SHRA28.5T1.8R2.5 | ✱ | 28.5 | 1.8 | 2.5 | 0.533 | 109.70 | 187.10 |
| SHA29.5T0.65 | ✱ | 29.5 | 0.65 | | 0.214 | 118.00 | 75.00 |
| SHA29.5T1.75 | ✱ | 29.5 | 1.75 | | 0.554 | 119.14 | 194.25 |
| SHA30T0.8 | ✱ | 30.0 | 0.8 | | 0.299 | 120.00 | 104.76 |
| SHRA30T1.5R1.5 | ✓ | 30.0 | 1.5 | 1.5 | 0.482 | 117.42 | 169.14 |
| SHA30T1.9 | ✱ | 30.0 | 1.9 | | 0.609 | 119.50 | 213.56 |
| SHRA30T2R2 | ✱ | 30.0 | 2.0 | 2.0 | 0.629 | 116.57 | 220.64 |
| SHRA30T2R3 | ✓ | 30.0 | 2.0 | 3.0 | 0.619 | 114.85 | 217.13 |
| SHA30T3 | ✓ | 30.0 | 3.0 | | 0.923 | 119.50 | 324.00 |
| SHA31.8T0.9 | ✱ | 31.8 | 0.9 | | 0.317 | 126.50 | 111.10 |
| SHRA32T1.2R3 | ✓ | 32.0 | 1.2 | 3.0 | 0.407 | 122.85 | 142.90 |
| SHRA32T2.3R3.5 | ✱ | 32.0 | 2.3 | 3.5 | 0.759 | 121.99 | 266.16 |
| SHA32T3 | ✓ | 32.0 | 3.0 | | 0.992 | 128.00 | 348.00 |
| SHRA32.1T1.45R3 | ✱ | 32.1 | 1.45 | 3.0 | 0.491 | 123.34 | 172.23 |
| SHRA33T3R5 | ✱ | 33.0 | 3.0 | 5.0 | 0.975 | 123.42 | 341.97 |
| SHRA34T1.6R3 | ✓ | 34.0 | 1.6 | 3.0 | 0.574 | 130.85 | 201.32 |
| SHA35T1 | ✱ | 35.0 | 1.0 | | 0.388 | 140.00 | 136.00 |
| SHRA35T1.6R1.5 | ✱ | 35.0 | 1.6 | 1.5 | 0.605 | 137.40 | 212.30 |
| SHA35T1.75 | ✱ | 35.0 | 1.75 | | 0.663 | 139.14 | 232.75 |
| SHRA35T2R2 | ✱ | 35.0 | 2.0 | 2.0 | 0.743 | 136.57 | 260.64 |
| SHA35T2 | ✱ | 35.0 | 3.0 | | 0.752 | 140.00 | 264.00 |
| SHA35T3 | ✱ | 35.0 | 3.0 | | 1.094 | 140.00 | 384.00 |
| SHRA36T1.5R1 | ✱ | 36.0 | 1.5 | 1.0 | 0.588 | 142.30 | 206.40 |
| SHA38T0.6 | ✱ | 38.0 | 0.6 | | 0.256 | 152.00 | 89.80 |
| SHA38T1 | ✱ | 38.0 | 1.0 | | 0.422 | 151.50 | 148.00 |
| SHA38T0.9 | ✱ | 38.0 | 0.9 | | 0.382 | 151.90 | 133.92 |
| SHA38T1.3 | ✱ | 38.0 | 1.3 | | 0.544 | 151.50 | 190.84 |
| SHA39T0.8 | ✱ | 39.0 | 0.8 | | 0.348 | 156.00 | 122.24 |
| SHA39.5T0.8 | ✱ | 39.5 | 0.8 | | 0.353 | 157.50 | 123.90 |
| SHA40T0.8 | ✱ | 40.0 | 0.8 | | 0.358 | 160.00 | 125.44 |

"✓" Stocked Item
 "✱" Pre-order Only Item
 (30-40 working days delivery)



Square Hollow

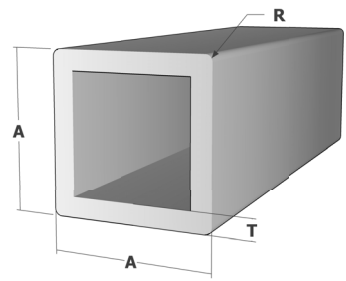

| Product Code | Ex Stock | A (mm) | T (mm) | R (mm) | Mass (kg/m) | Perimeter (mm) | Area (mm ²) |
|----------------|----------|--------|--------|--------|-------------|----------------|-------------------------|
| SHA40T1.2 | ✱ | 40.0 | 1.2 | | 0.531 | 160.00 | 186.24 |
| SHA40T1.5 | ✱ | 40.0 | 1.5 | | 0.658 | 160.00 | 230.92 |
| GM-PF-23 | ✱ | 40.0 | 2.0 | 3.5 | 0.842 | 154.00 | 295.40 |
| SHA40T2 | ✓ | 40.0 | 2.0 | | 0.866 | 160.00 | 304.00 |
| SHRA40T2R3 | ✓ | 40.0 | 2.0 | 3.0 | 0.847 | 154.85 | 297.13 |
| SHRA40T2.5R3.5 | ✱ | 40.0 | 2.5 | 3.5 | 1.041 | 154.00 | 365.30 |
| SHA40T3 | ✓ | 40.0 | 3.0 | | 1.265 | 160.00 | 444.00 |
| SHRA40T3R3 | ✓ | 40.0 | 3.0 | 3.0 | 1.243 | 154.85 | 436.27 |
| SHA40T4 | ✓ | 40.0 | 4.0 | | 1.642 | 160.00 | 576.00 |
| SHA44.5T0.9 | ✱ | 44.5 | 0.9 | | 0.447 | 117.30 | 156.78 |
| SHA45T0.6 | ✱ | 45.0 | 0.6 | | 0.304 | 180.00 | 106.56 |
| SHA45T0.8 | ✱ | 45.0 | 0.8 | | 0.378 | 179.49 | 132.67 |
| SHRA45T1.6R2 | ✱ | 45.0 | 1.6 | 2.0 | 0.783 | 176.60 | 274.60 |
| SHRA45T2R3.5 | ✱ | 45.0 | 2.0 | 3.5 | 0.960 | 174.00 | 335.42 |
| SHA50T0.8 | ✱ | 50.0 | 0.8 | | 0.449 | 199.50 | 157.44 |
| SHA50T1.0 | ✱ | 50.0 | 1.0 | | 0.559 | 199.50 | 196.00 |
| SHA50T1.2 | ✓ | 50.0 | 1.2 | | 0.667 | 199.50 | 234.20 |
| SHA50T1.4 | ✱ | 50.0 | 1.4 | | 0.776 | 200.00 | 272.16 |
| SHA50T2.0 | ✓ | 50.0 | 2.0 | | 1.094 | 200.00 | 384.00 |
| SHRA50T2.0R3 | ✓ | 50.0 | 2.0 | 3.0 | 1.075 | 194.85 | 377.13 |
| SHA50T2.5 | ✱ | 50.0 | 2.5 | | 1.356 | 200.00 | 475.86 |
| SHA50T3 | ✓ | 50.0 | 3.0 | | 1.607 | 200.00 | 564.00 |
| SHRA50T3R3 | ✓ | 50.0 | 3.0 | 3.0 | 1.585 | 194.85 | 556.28 |
| SHA50T3.5 | ✱ | 50.0 | 3.5 | | 1.855 | 200.00 | 650.86 |
| SHA50T4 | ✓ | 50.0 | 4.0 | | 2.098 | 200.00 | 736.00 |
| SHA50T5 | ✓ | 50.0 | 5.0 | | 2.565 | 200.00 | 900.00 |
| SHA60T1.5 | ✱ | 60.0 | 1.5 | | 1.000 | 239.50 | 351.00 |
| SHA60T2 | ✱ | 60.0 | 2.0 | | 1.322 | 240.00 | 464.00 |
| SHRA60T2R3.5 | ✱ | 60.0 | 2.0 | 3.5 | 1.298 | 221.43 | 455.42 |
| SHA60T2.5 | ✓ | 60.0 | 2.5 | | 1.639 | 240.00 | 575.00 |
| SHRA60T2.7R3.5 | ✱ | 60.0 | 2.7 | 3.5 | 1.735 | 234.00 | 608.90 |
| SHA60T6 | ✱ | 60.0 | 6.0 | | 3.694 | 240.00 | 1296.00 |
| SHRA65T2.5R3 | ✓ | 65.0 | 2.5 | 3.0 | 1.760 | 254.85 | 617.49 |
| SHRA70T4 | ✱ | 70.0 | 4.0 | | 3.010 | 280.00 | 1056.00 |
| SHA75T1.6 | ✓ | 75.0 | 1.6 | | 1.339 | 299.20 | 469.80 |
| SHA75T3.0 | ✓ | 75.0 | 3.0 | | 2.462 | 299.50 | 864.00 |
| SHRA75T3R3 | ✓ | 75.0 | 3.0 | 3.0 | 2.440 | 294.85 | 856.27 |
| SHA75T4 | ✓ | 75.0 | 4.0 | | 3.238 | 299.50 | 1136.00 |
| SHA80T1.5 | ✱ | 80.0 | 1.5 | | 1.342 | 320.00 | 471.00 |
| SHA80T1.8 | ✓ | 80.0 | 1.8 | | 1.605 | 320.00 | 563.04 |

"✓" Stocked Item
 "✱" Pre-order Only Item
 (30-40 working days delivery)



Square Hollow

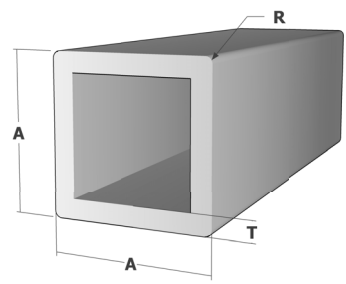

| Product Code | Ex Stock | A (mm) | T (mm) | R (mm) | Mass (kg/m) | Perimeter (mm) | Area (mm ²) |
|----------------|----------|--------|--------|--------|-------------|----------------|-------------------------|
| SHRA80T2.5R3.5 | ✱ | 80.0 | 2.5 | 3.5 | 2.181 | 314.00 | 765.34 |
| SHRA80T5R10 | ✱ | 80.0 | 5.0 | 10.0 | 4.092 | 302.80 | 1435.62 |
| SHRA90T1.6R8 | ✱ | 90.0 | 1.6 | 8.0 | 1.556 | 346.27 | 545.98 |
| SHA90T1.8 | ✱ | 90.0 | 1.8 | | 1.810 | 360.00 | 635.10 |
| SHA90T1.9 | ✱ | 90.0 | 1.9 | | 1.908 | 360.00 | 669.59 |
| SHA90T3 | ✓ | 90.0 | 3.0 | | 2.975 | 359.14 | 1043.86 |
| SHA90T6 | ✓ | 90.0 | 6.0 | | 5.746 | 360.00 | 2016.00 |
| SHA100T1 | ✱ | 100.0 | 1.0 | | 1.129 | 400.00 | 396.00 |
| SHA100T1.3 | ✱ | 100.0 | 1.3 | | 1.463 | 400.00 | 513.27 |
| SHA100T2 | ✱ | 100.0 | 2.0 | | 2.234 | 400.00 | 784.00 |
| SHRA100T3R3 | ✓ | 100.0 | 3.0 | 3.0 | 3.296 | 394.85 | 1156.50 |
| SHA100T3 | ✓ | 100.0 | 3.0 | | 3.317 | 400.00 | 1164.00 |
| SHA100T4 | ✓ | 100.0 | 4.0 | | 4.378 | 400.00 | 1536.00 |
| SHA100T5 | ✓ | 100.0 | 5.0 | | 5.415 | 400.00 | 1900.00 |
| SHA120T3R1 | ✓ | 120.0 | 3.0 | 1 | 4.000 | 478.30 | 1403.40 |
| SHA150T3 | ✓ | 150.0 | 3.0 | | 5.027 | 600.00 | 1764.00 |
| SHA150T10 | ✓ | 150.0 | 10.0 | | 15.960 | 600.00 | 5600.00 |
| SHA200T10 | ✓ | 200.0 | 10.0 | | 21.660 | 800.00 | 7600.00 |

“✓” Stocked Item
 “*” Pre-order Only Item
 (30-40 working days delivery)



Rectangular Hollow

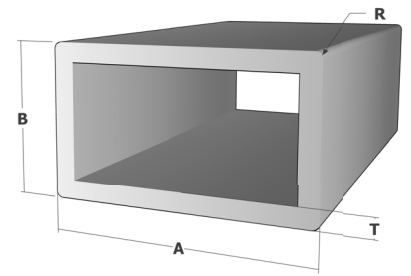

| Product Code | Ex Stock | A (mm) | B (mm) | T (mm) | R (mm) | Mass (kg/m) | Perimeter (mm) | Area (mm ²) |
|---------------------|----------|--------|--------|--------|--------|-------------|----------------|-------------------------|
| RHA15B10T1 | * | 15.0 | 10.0 | 1.0 | | 0.131 | 50.00 | 46.00 |
| RHA15B12T1.2 | * | 15.0 | 12.0 | 1.2 | | 0.168 | 54.00 | 59.04 |
| RHRA17.8B13.8T1.4R2 | * | 17.8 | 13.8 | 1.4 | 2.0 | 0.226 | 59.80 | 79.14 |
| RHRA18B14T2R1.5 | * | 18.0 | 14.0 | 2.0 | 1.5 | 0.314 | 61.43 | 110.10 |
| RHA18.1B7.2T1.5 | * | 18.1 | 7.2 | 1.5 | | 0.191 | 50.09 | 66.90 |
| RHRA18.5B13T1R1.3 | * | 18.5 | 13.0 | 1.0 | 1.3 | 0.165 | 60.86 | 57.87 |
| RHA20B10T1.2 | ✓ | 20.0 | 10.0 | 1.2 | | 0.189 | 59.50 | 66.24 |
| RHA20B12T1.2 | ✓ | 20.0 | 12.0 | 1.2 | | 0.202 | 64.00 | 71.00 |
| RHRA20B15T1.4R1 | * | 20.0 | 15.0 | 1.4 | 1.0 | 0.255 | 69.50 | 89.38 |
| RHA20B15T2 | ✓ | 20.0 | 15.0 | 2.0 | | 0.353 | 70.00 | 124.00 |
| RHA21B12.5T1 | * | 21.0 | 12.5 | 1.0 | | 0.180 | 66.50 | 63.00 |
| RHA22B10T2 | * | 22.0 | 10.0 | 2.0 | | 0.319 | 64.00 | 112.00 |
| RHRA22.3B18.3T0.8R1 | * | 22.3 | 18.3 | 0.8 | 1.0 | 0.175 | 80.68 | 61.56 |
| RHRA23B17T1.2R3 | * | 23.0 | 17.0 | 1.2 | 3.0 | 0.243 | 74.90 | 85.30 |
| RHA23.8B10.9T1 | * | 23.8 | 10.9 | 1.0 | | 0.186 | 68.54 | 65.4 |
| RHA24B8T2 | * | 24.0 | 8.0 | 2.0 | | 0.319 | 64.00 | 112.00 |
| RHRA25B9T1.2R2 | * | 25.0 | 9.0 | 1.2 | 2.0 | 0.208 | 64.60 | 73.00 |
| RHA25B15T0.45 | * | 25.0 | 15.0 | 0.45 | | 0.100 | 79.70 | 35.20 |
| RHA25B15T1 | * | 25.0 | 15.0 | 1.0 | | 0.217 | 79.50 | 76.00 |
| RHRA25B15T2.5R2 | * | 25.0 | 15.0 | 2.5 | 2.0 | 0.496 | 76.60 | 174.20 |
| RHA25B20T1 | * | 25.0 | 20.0 | 1.0 | | 0.245 | 89.50 | 86.00 |
| RHA25.1B10.1T0.8 | * | 25.1 | 10.1 | 0.8 | | 0.153 | 70.00 | 53.76 |
| RHA25.4B12.7T0.9 | * | 25.4 | 12.7 | 0.9 | | 0.186 | 75.69 | 65.34 |
| RHA26.1B16.5T0.52 | * | 26.1 | 16.5 | 0.52 | | 0.123 | 85.20 | 43.22 |
| RHA28B15T1 | * | 28.0 | 15.0 | 1.0 | | 0.234 | 85.50 | 82.00 |
| RHRA28B18T0.7R4 | * | 28.0 | 18.0 | 0.7 | 4.0 | 0.165 | 85.10 | 58.05 |
| RHA29.2B10T0.65 | * | 29.2 | 10.0 | 0.65 | | 0.171 | 77.59 | 59.84 |
| RHRA29.9B19.9T1R1.5 | * | 29.9 | 19.9 | 1.0 | 1.5 | 0.267 | 98.86 | 93.70 |
| RHRA30B10T1.5R1.5 | * | 30.0 | 10.0 | 1.5 | 1.5 | 0.311 | 77.40 | 109.20 |
| RHA30B10T2 | ✓ | 30.0 | 10.0 | 2.0 | | 0.405 | 79.00 | 142.00 |
| RHA30B15T1 | * | 30.0 | 15.0 | 1.0 | | 0.245 | 90.00 | 86.00 |
| RHA30B15T1.2 | * | 30.0 | 15.0 | 1.2 | | 0.291 | 89.50 | 102.20 |
| RHRA30B15T2R2.5 | * | 30.0 | 15.0 | 2.0 | 2.5 | 0.453 | 85.70 | 158.90 |
| RHRA30B15T2.2R2 | * | 30.0 | 15.0 | 2.2 | 2.0 | 0.500 | 86.60 | 175.40 |
| RHA30B18T1 | * | 30.0 | 18.0 | 1.0 | | 0.262 | 95.50 | 92.00 |
| RHRA30B18T1.5R2 | * | 30.0 | 18.0 | 1.5 | 2.0 | 0.375 | 92.56 | 131.58 |
| RHA30B20T0.8 | ✓ | 30.0 | 20.0 | 0.8 | | 0.221 | 100.00 | 77.50 |
| RHRA30B20T1R1.5 | * | 30.0 | 20.0 | 1.0 | 1.5 | 0.269 | 97.40 | 94.30 |
| RHA30B20T1.2 | * | 30.0 | 20.0 | 1.2 | | 0.325 | 99.50 | 114.20 |
| RHRA30B20T1.5R1.5 | * | 30.0 | 20.0 | 1.5 | 1.5 | 0.397 | 97.42 | 139.14 |

“✓” Stocked Item
 “✳” Pre-order Only Item
 (30-40 working days delivery)



Rectangular Hollow

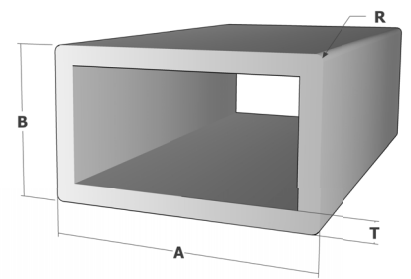

| Product Code | Ex Stock | A (mm) | B (mm) | T (mm) | R (mm) | Mass (kg/m) | Perimeter (mm) | Area (mm ²) |
|----------------------|----------|--------|--------|--------|--------|-------------|----------------|-------------------------|
| RHRA30B20T1.6R1.5 | * | 30.0 | 20.0 | 1.6 | 1.5 | 0.422 | 97.40 | 147.90 |
| RHA30B20T1.8 | ✓ | 30.0 | 20.0 | 1.8 | | 0.476 | 100.00 | 167.00 |
| RHRA32B16T1.5R2.2 | * | 32.0 | 16.0 | 1.5 | 2.2 | 0.385 | 92.22 | 135.00 |
| RHRA32B27T1.8R1 | * | 32.0 | 27.0 | 1.8 | 1.0 | 0.566 | 116.28 | 198.66 |
| RHRA34.5B12T1.2R1 | * | 34.5 | 12.0 | 1.2 | 1.0 | 0.300 | 91.50 | 105.20 |
| RHRA34.8B24.8T0.65R2 | * | 34.8 | 24.8 | 0.65 | 2.0 | 0.211 | 116.00 | 73.92 |
| RHA35B20T0.4 | * | 35.0 | 20.0 | 0.4 | | 0.123 | 109.49 | 43.28 |
| RHA35B20T0.5 | * | 35.0 | 20.0 | 0.5 | | 0.154 | 109.50 | 54.00 |
| RHRA35B25T1.5R3 | * | 35.0 | 25.0 | 1.5 | 3.0 | 0.471 | 114.85 | 165.20 |
| RHA36B23T0.5 | * | 36.0 | 23.0 | 0.5 | | 0.165 | 117.50 | 58.00 |
| RHA37.2B24.2T1.1 | * | 37.2 | 24.2 | 1.1 | | 0.371 | 122.30 | 130.24 |
| RHRA38B7T1.2R1 | * | 38.0 | 7.0 | 1.2 | 1.0 | 0.289 | 88.30 | 101.50 |
| RHA38B13T2.5 | * | 38.0 | 13.0 | 2.5 | | 0.654 | 102.50 | 229.64 |
| RHA38B25T0.5 | * | 38.0 | 25.0 | 0.5 | | 0.177 | 125.50 | 62.00 |
| RHA38B25T0.6 | * | 38.0 | 25.0 | 0.6 | | 0.211 | 126.00 | 74.16 |
| RHA38B25T0.9 | * | 38.0 | 25.0 | 0.9 | | 0.314 | 125.50 | 110.20 |
| RHA38B25T1 | * | 38.0 | 25.0 | 1.0 | | 0.348 | 126.00 | 122.00 |
| RHA38B25T1.2 | * | 38.0 | 25.0 | 1.2 | | 0.415 | 126.00 | 145.44 |
| RHRA38B25T1.5R3 | ✓ | 38.0 | 25.0 | 1.5 | 3.0 | 0.496 | 120.85 | 174.21 |
| RHA38B25T2 | ✓ | 38.0 | 25.0 | 2.0 | | 0.672 | 125.14 | 235.86 |
| RHRA38B25T2.5R3 | ✓ | 38.0 | 25.0 | 2.5 | 3.0 | 0.805 | 120.85 | 282.49 |
| RHA38B25T3 | * | 38.0 | 25.0 | 3.0 | | 0.975 | 126.00 | 342.00 |
| RHA38B25.4T0.9 | * | 38.0 | 25.4 | 0.9 | | 0.317 | 126.50 | 111.10 |
| RHA40B20T0.75 | * | 40.0 | 20.0 | 0.75 | | 0.250 | 120.00 | 87.75 |
| RHA40B20T0.9 | * | 40.0 | 20.0 | 0.9 | | 0.298 | 119.49 | 104.68 |
| RHA40B20T1 | * | 40.0 | 20.0 | 1.0 | | 0.329 | 119.49 | 115.41 |
| RHA40B20T1.2 | ✓ | 40.0 | 20.0 | 1.2 | | 0.394 | 119.50 | 138.20 |
| RHRA40B20T1.6R2 | ✓ | 40.0 | 20.0 | 1.6 | 2.0 | 0.509 | 116.60 | 178.54 |
| RHRA40B20T2R2 | * | 40.0 | 20.0 | 2.0 | 2.0 | 0.629 | 116.57 | 220.64 |
| RHA40B20T2.5 | * | 40.0 | 20.0 | 2.5 | | 0.784 | 120.00 | 275.00 |
| RHA40B20T3 | ✓ | 40.0 | 20.0 | 3.0 | | 0.923 | 120.00 | 324.00 |
| RHA40B25T2 | ✓ | 40.0 | 25.0 | 2.0 | | 0.695 | 130.00 | 244.00 |
| RHRA40B25T2.5R3 | * | 40.0 | 25.0 | 2.5 | 3.0 | 0.834 | 124.85 | 292.49 |
| RHA40B30T0.7 | * | 40.0 | 30.0 | 0.7 | | 0.274 | 139.49 | 96.04 |
| RHA40B30T2 | * | 40.0 | 30.0 | 2.0 | | 0.750 | 138.28 | 263.22 |
| RHA40.6B23.6T0.8 | * | 40.6 | 23.6 | 0.8 | | 0.286 | 128.40 | 100.20 |
| RHA42.4B35T2 | * | 42.4 | 35.0 | 2.0 | | 0.832 | 154.00 | 292.00 |
| RHA45B20T1.5 | * | 45.0 | 20.0 | 1.5 | | 0.530 | 129.66 | 186.00 |
| RHA45B25T0.6 | * | 45.0 | 25.0 | 0.6 | | 0.235 | 140.00 | 82.56 |
| RHRA45B35T1R2 | * | 45.0 | 35.0 | 1.0 | 2.0 | 0.437 | 156.57 | 153.43 |

“✓” Stocked Item
 “*” Pre-order Only Item
 (30-40 working days delivery)



Rectangular Hollow

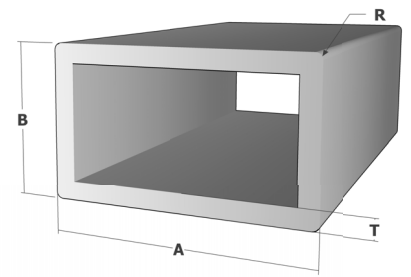

| Product Code | Ex Stock | A (mm) | B (mm) | T (mm) | R (mm) | Mass (kg/m) | Perimeter (mm) | Area (mm ²) |
|-----------------------|----------|--------|--------|--------|--------|-------------|----------------|-------------------------|
| RHA45B40T3 | * | 45.0 | 40.0 | 3.0 | | 1.351 | 170.00 | 474.00 |
| RHRA50B20T0.8R3 | * | 50.0 | 20.0 | 0.8 | 3.0 | 0.305 | 135.00 | 107.00 |
| RHA50B25T0.6 | * | 50.0 | 25.0 | 0.6 | | 0.252 | 149.50 | 88.56 |
| RHA50B25T0.8 | * | 50.0 | 25.0 | 0.8 | | 0.314 | 149.49 | 110.17 |
| RHA50B25T1.2 | ✓ | 50.0 | 25.0 | 1.2 | | 0.496 | 150.00 | 174.20 |
| RHA50B25T1.6 | ✓ | 50.0 | 25.0 | 1.6 | | 0.654 | 149.00 | 229.60 |
| RHA50B25T2.5 | * | 50.0 | 25.0 | 2.5 | | 0.998 | 150.00 | 350.00 |
| RHA50B25T3 | ✓ | 50.0 | 25.0 | 3.0 | | 1.180 | 150.00 | 414.00 |
| RHRA50B25T3R3 | ✓ | 50.0 | 25.0 | 3.0 | 3.0 | 1.158 | 144.85 | 406.27 |
| RHA50B30T1.2 | * | 50.0 | 30.0 | 1.2 | | 0.531 | 160.00 | 186.20 |
| RHA50B30T1.5 | * | 50.0 | 30.0 | 1.5 | | 0.658 | 160.00 | 231.00 |
| RHA50B30T2 | * | 50.0 | 30.0 | 2.0 | | 0.866 | 160.00 | 304.00 |
| RHA50B34T1.5 | * | 50.0 | 34.0 | 1.5 | | 0.693 | 168.00 | 243.00 |
| RHRA50B34T2R3.5 | * | 50.0 | 34.0 | 2.0 | 3.5 | 0.887 | 162.00 | 311.40 |
| RHA50B35T3 | * | 50.0 | 35.0 | 3.0 | | 1.351 | 170.00 | 474.00 |
| RHA50B38.5T2 | * | 50.0 | 38.5 | 2.0 | | 0.963 | 176.14 | 338.00 |
| RHA50B40T2 | ✓ | 50.0 | 40.0 | 2.0 | | 0.980 | 180.00 | 344.00 |
| RHRA50B40T2R3 | ✓ | 50.0 | 40.0 | 2.0 | 3.0 | 0.961 | 174.85 | 337.13 |
| RHRA50B40T3R5 | * | 50.0 | 40.0 | 3.0 | 5.0 | 1.385 | 171.42 | 485.97 |
| RHA50.2B25.4T0.9 | * | 50.2 | 25.4 | 0.9 | | 0.378 | 150.70 | 132.80 |
| RHA50.8B38.1T0.9 | * | 50.8 | 38.1 | 0.9 | | 0.447 | 177.30 | 156.80 |
| RHRA51B39T1.8R1.5 | * | 51.0 | 39.0 | 1.8 | 1.5 | 0.881 | 177.43 | 309.11 |
| RHA53B30T1 | * | 53.0 | 30.0 | 1.0 | | 0.462 | 165.49 | 162.00 |
| RHA54.7B11T0.7 | * | 54.7 | 11.0 | 0.7 | | 0.257 | 131.40 | 90.00 |
| RHA55B9T1.3 | * | 55.0 | 9.0 | 1.3 | | 0.455 | 127.50 | 159.56 |
| RHA55B15T0.7 | * | 55.0 | 15.0 | 0.7 | | 0.324 | 139.49 | 113.72 |
| RHA55B22T0.7 | ✓ | 55.0 | 22.0 | 0.7 | | 0.302 | 153.49 | 105.84 |
| RHA55B30T1 | * | 55.0 | 30.0 | 1.0 | | 0.473 | 170.00 | 166.00 |
| RHA55B40T3 | * | 55.0 | 40.0 | 4.0 | 3.0 | 1.522 | 190.00 | 534.00 |
| RHRA55B40T4R2 | * | 55.0 | 40.0 | 4.0 | 2.0 | 1.984 | 186.70 | 696.00 |
| RHRA55.5B11.2T0.8R1.5 | * | 55.5 | 11.2 | 0.8 | 1.5 | 0.297 | 130.82 | 104.16 |
| RHA59B18T1.5 | * | 59.0 | 18.0 | 1.5 | | 0.633 | 154.00 | 222.00 |
| RHA60B20T1.2 | * | 60.0 | 20.0 | 1.2 | | 0.531 | 159.50 | 186.20 |
| RHRA60B25T1.3R3 | * | 60.0 | 25.0 | 1.3 | 3.0 | 0.596 | 164.85 | 209.00 |
| RHRA60B25T1.5R3 | * | 60.0 | 25.0 | 1.5 | 3.0 | 0.701 | 164.90 | 246.00 |
| RHRA60B25T1.5R5.5 | * | 60.0 | 25.0 | 1.5 | 5.5 | 0.672 | 160.56 | 235.91 |
| RHRA60B26T2R5 | * | 60.0 | 26.0 | 2.0 | 5.0 | 0.896 | 163.42 | 314.27 |
| RHA60B40T2 | ✓ | 60.0 | 40.0 | 2.0 | | 1.094 | 200.00 | 384.00 |
| RHRA60B40T2R3 | ✓ | 60.0 | 40.0 | 2.0 | 3.0 | 1.075 | 195.0 | 377.13 |
| RHA60B40T2.5 | * | 60.0 | 40.0 | 2.5 | | 1.354 | 199.50 | 475.00 |

"✓" Stocked Item
 "✱" Pre-order Only Item
 (30-40 working days delivery)



Rectangular Hollow

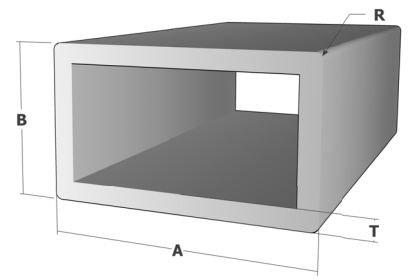

| Product Code | Ex Stock | A (mm) | B (mm) | T (mm) | R (mm) | Mass (kg/m) | Perimeter (mm) | Area (mm ²) |
|---------------------|----------|--------|--------|--------|--------|-------------|----------------|-------------------------|
| RHA60B40T3 | ✓ | 60.0 | 40.0 | 3.0 | | 1.607 | 199.20 | 563.90 |
| RHRA60B40T3R6 | ✱ | 60.0 | 40.0 | 3.0 | 6.0 | 1.600 | 196.57 | 561.42 |
| RHA60B40T3.8 | ✱ | 60.0 | 40.0 | 3.8 | | 2.001 | 200.00 | 702.24 |
| RHA60B40T4 | ✓ | 60.0 | 40.0 | 4.0 | | 2.098 | 200.00 | 736.00 |
| RHRA60B40T5R2 | ✱ | 60.0 | 40.0 | 5.0 | 2.0 | 2.555 | 196.57 | 896.57 |
| RHRA62.8B17.6T0.8R4 | ✱ | 62.8 | 17.6 | 0.8 | 4.0 | 0.345 | 153.93 | 121.14 |
| RHA64B25T0.9 | ✱ | 64.0 | 25.0 | 0.9 | | 0.447 | 178.00 | 156.96 |
| RHRA65B16T1.2R2 | ✓ | 65.0 | 16.0 | 1.2 | 2.0 | 0.568 | 161.50 | 199.30 |
| RHA65B16T1.2 | ✱ | 65.0 | 16.0 | 1.2 | | 0.529 | 158.57 | 185.76 |
| RHA65B50T3 | ✓ | 65.0 | 50.0 | 3.0 | | 1.864 | 229.14 | 653.86 |
| RHA69.9B19.9T0.9 | ✱ | 69.9 | 19.9 | 0.9 | | 0.451 | 179.00 | 158.31 |
| RHA70B20T1 | ✱ | 70.0 | 20.0 | 1.0 | | 0.500 | 179.49 | 175.41 |
| RHRA70B25T4R2 | ✱ | 70.0 | 25.0 | 4.0 | 2.0 | 1.984 | 190.00 | 696.00 |
| RHRA70B25.5T0.9R3.5 | ✱ | 70.0 | 25.5 | 0.9 | 3.5 | 0.447 | 184.99 | 156.83 |
| RHA70B30.2T1 | ✱ | 70.0 | 30.2 | 1.0 | | 0.450 | 199.89 | 157.76 |
| RHA70B40T3 | ✓ | 70.0 | 40.0 | 3.0 | | 1.778 | 219.14 | 623.86 |
| RHA71.6B21.3T1 | ✱ | 71.6 | 21.3 | 1.0 | | 0.518 | 185.29 | 181.80 |
| RHRA74B25T1.8R3 | ✱ | 74.0 | 25.0 | 1.8 | 3.0 | 1.052 | 192.85 | 369.11 |
| RHA75B25T2.2 | ✓ | 75.0 | 25.0 | 2.2 | | 1.199 | 199.20 | 420.70 |
| RHA75B40T2 | ✓ | 75.0 | 40.0 | 2.0 | | 1.265 | 230.00 | 444.00 |
| RHA75B45T0.8 | ✱ | 75.0 | 45.0 | 0.8 | | 0.507 | 239.50 | 177.80 |
| RHA75B45T3 | ✓ | 75.0 | 45.0 | 3.0 | | 1.949 | 239.14 | 683.86 |
| RHA75B50T3 | ✓ | 75.0 | 50.0 | 3.0 | | 2.035 | 249.50 | 714.00 |
| RHA76B25T1.2 | ✱ | 76.0 | 25.0 | 1.2 | | 0.674 | 201.50 | 236.60 |
| RHA76B25T1.5 | ✱ | 76.0 | 25.0 | 1.5 | | 0.838 | 201.50 | 294.00 |
| RHA76B44T0.7 | ✱ | 76.0 | 44.0 | 0.7 | | 0.473 | 240.00 | 166.00 |
| RHA76B44T1 | ✱ | 76.0 | 44.0 | 1.0 | | 0.673 | 240.00 | 236.00 |
| RHA76B44T1.2 | ✱ | 76.0 | 44.0 | 1.2 | | 0.804 | 240.00 | 282.20 |
| RHA76B44T1.4 | ✱ | 76.0 | 44.0 | 1.4 | | 0.935 | 240.00 | 328.00 |
| RHA76B44T1.5 | ✱ | 76.0 | 44.0 | 1.5 | | 1.000 | 240.00 | 351.00 |
| RHA76B44T2.0 | ✓ | 76.0 | 44.0 | 2.0 | | 1.322 | 240.00 | 464.00 |
| RHA76B25.4T0.9 | ✓ | 76.0 | 25.4 | 0.9 | | 0.512 | 202.70 | 179.60 |
| RHA76B44.5T0.9 | ✱ | 76.0 | 44.5 | 0.9 | | 0.610 | 240.80 | 214.00 |
| RHRA77B32T2.7R3 | ✓ | 77.0 | 32.0 | 2.7 | 3.0 | 1.573 | 212.85 | 551.80 |
| RHRA78.6B35.4T2R3 | ✱ | 78.6 | 35.4 | 2.0 | 3.0 | 1.234 | 222.85 | 433.13 |
| RHRA79.5B19.9T0.85 | ✱ | 79.5 | 19.9 | 0.85 | | 0.473 | 198.00 | 166.10 |
| RHRA80B16T1.1R2 | ✓ | 80.0 | 16.0 | 1.1 | 2.0 | 0.580 | 188.57 | 203.62 |
| RHA80B20T0.7 | ✓ | 80.0 | 20.0 | 0.7 | | 0.449 | 199.50 | 157.50 |
| RHA80B25T1 | ✱ | 80.0 | 25.0 | 1.0 | | 0.587 | 209.50 | 206.00 |
| RHA80B40T0.9 | ✱ | 80.0 | 40.0 | 0.9 | | 0.573 | 240.00 | 201.11 |

“✓” Stocked Item
 “*” Pre-order Only Item
 (30-40 working days delivery)



Rectangular Hollow

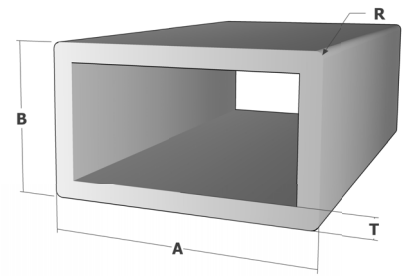

| Product Code | Ex Stock | A (mm) | B (mm) | T (mm) | R (mm) | Mass (kg/m) | Perimeter (mm) | Area (mm ²) |
|--------------------|----------|--------|--------|--------|--------|-------------|----------------|-------------------------|
| RHA80B40T1.5 | * | 80.0 | 40.0 | 1.5 | | 1.000 | 240.00 | 350.90 |
| RHA80B40T1.8 | ✓ | 80.0 | 40.0 | 1.8 | | 1.194 | 240.00 | 419.00 |
| RHRA80B40T2R3 | ✓ | 80.0 | 40.0 | 2.0 | 3.0 | 1.303 | 243.85 | 457.13 |
| RHRA80B40T3.5R3 | * | 80.0 | 40.0 | 3.5 | 3.0 | 2.254 | 234.80 | 791.00 |
| RHA80B50T3 | ✓ | 80.0 | 50.0 | 3.0 | | 2.120 | 260.00 | 744.00 |
| RHRA80B50T3R3 | ✓ | 80.0 | 50.0 | 3.0 | 3.0 | 2.098 | 254.85 | 736.28 |
| RHA80B60T6 | * | 80.0 | 60.0 | 6.0 | | 4.378 | 280.00 | 1536.00 |
| RHA90B25T4 | * | 90.0 | 25.0 | 4.0 | | 2.440 | 229.50 | 856.00 |
| RHA90B50T2 | ✓ | 90.0 | 50.0 | 2.0 | | 1.550 | 279.14 | 543.86 |
| RHA90B50T6 | ✓ | 90.0 | 50.0 | 6.0 | | 4.378 | 280.00 | 1536.00 |
| RHA90B60T3 | * | 90.0 | 60.0 | 3.0 | | 2.384 | 300.00 | 836.50 |
| RHRA90B60T5R5 | * | 90.0 | 60.0 | 5.0 | 5.0 | 4.051 | 300.00 | 1421.46 |
| RHA100B15T1.2 | * | 100.0 | 15.0 | 1.2 | | 0.770 | 229.50 | 270.20 |
| RHA100B15T1.3 | * | 100.0 | 15.0 | 1.3 | | 0.833 | 230.00 | 292.24 |
| RHRA100B18T2.3R2 | * | 100.0 | 18.0 | 2.3 | 2.0 | 1.388 | 236.00 | 486.91 |
| RHA100B19.7T1.4 | ✓ | 100.0 | 19.7 | 1.4 | | 0.933 | 238.50 | 372.20 |
| RHA100B19.7T1.4 | * | 100.0 | 19.7 | 1.4 | | 0.949 | 238.50 | 333.10 |
| RHA100B20T0.8 | * | 100.0 | 20.0 | 0.8 | | 0.540 | 240.00 | 189.44 |
| RHA100B20T1.2 | * | 100.0 | 20.0 | 1.2 | | 0.804 | 239.49 | 282.24 |
| RHA100B25T1.5 | * | 100.0 | 25.0 | 1.5 | | 1.043 | 250.00 | 366.00 |
| RHA100B25T2.5 | ✓ | 100.0 | 25.0 | 2.5 | | 1.710 | 249.20 | 600.00 |
| RHA100B30T1.5 | * | 100.0 | 30.0 | 1.5 | | 1.086 | 260.00 | 381.00 |
| RHA100B40T2 | ✓ | 100.0 | 40.0 | 2.0 | | 1.550 | 280.00 | 544.00 |
| RHA100B44T1.4 | ✓ | 100.0 | 44.0 | 1.4 | | 1.127 | 288.00 | 395.40 |
| RHA100B44T2 | * | 100.0 | 44.0 | 2.0 | | 1.596 | 288.00 | 560.10 |
| RHA100B44T3 | * | 100.0 | 44.0 | 3.0 | | 2.360 | 288.00 | 828.00 |
| RHA100B45T0.8 | * | 100.0 | 45.0 | 0.8 | | 0.613 | 289.49 | 215.17 |
| RHA100B45T3 | * | 100.0 | 45.0 | 3.0 | | 2.377 | 290.00 | 834.00 |
| RHA100B45T4 | * | 100.0 | 45.0 | 4.0 | | 3.124 | 290.00 | 1096.00 |
| RHA100B50T1.5 | * | 100.0 | 50.0 | 1.5 | | 1.257 | 300.00 | 441.00 |
| RHA100B50T2.5 | * | 100.0 | 50.0 | 2.5 | | 2.066 | 300.00 | 725.00 |
| RHA100B50T3 | ✓ | 100.0 | 50.0 | 3.0 | | 2.462 | 300.00 | 864.00 |
| RHRA100B50T3R3 | ✓ | 100.0 | 50.0 | 3.0 | 3.0 | 2.440 | 294.85 | 856.28 |
| RHA100B50T6 | ✓ | 100.0 | 50.0 | 6.0 | | 4.719 | 299.20 | 1655.90 |
| RHRA100B55T2.5R1.5 | * | 100.0 | 55.0 | 2.5 | 1.5 | 2.135 | 307.00 | 749.00 |
| RHA100B60T2 | * | 100.0 | 60.0 | 2.0 | | 1.778 | 320.00 | 624.00 |
| RHRA100B60T5R1 | * | 100.0 | 60.0 | 5.0 | 1.0 | 4.273 | 318.28 | 1499.22 |
| RHA100B80T1.8 | * | 100.0 | 80.0 | 1.8 | | 1.810 | 360.00 | 635.00 |
| RHA100B80T2 | ✓ | 100.0 | 80.0 | 2.0 | | 2.006 | 360.00 | 704.00 |
| RHRA101.6B25.4T0.9 | * | 101.6 | 25.4 | 0.9 | | 0.642 | 253.50 | 225.40 |

“✓” Stocked Item
 “*” Pre-order Only Item
 (30-40 working days delivery)



Rectangular Hollow

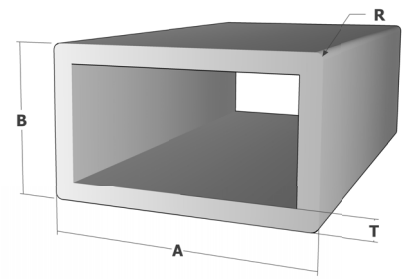

| Product Code | Ex Stock | A (mm) | B (mm) | T (mm) | R (mm) | Mass (kg/m) | Perimeter (mm) | Area (mm ²) |
|-----------------------|----------|--------|--------|--------|--------|-------------|----------------|-------------------------|
| RHA101.6B44.5T1 | * | 101.6 | 44.5 | 1.0 | | 0.659 | 291.60 | 231.12 |
| RHRA102B75T2.5R7.5 | * | 102.0 | 75.0 | 2.5 | 7.5 | 2.375 | 341.12 | 833.18 |
| RHA120B25T4 | ✓ | 120.0 | 25.0 | 4.0 | | 3.124 | 290.00 | 1096.00 |
| RHA120B60T2 | * | 120.0 | 60.0 | 2.0 | | 2.006 | 360.00 | 704.00 |
| RHA120B60T2.9 | ✓ | 120.0 | 60.0 | 2.9 | | 2.880 | 360.00 | 1010.40 |
| RHA120B60T5 | ✓ | 120.0 | 60.0 | 5.0 | | 4.845 | 360.00 | 1700.00 |
| RHA120B60T6 | ✓ | 120.0 | 60.0 | 6.0 | | 5.746 | 360.00 | 2016.00 |
| RHRA120B66T3.9R2 | * | 120.0 | 66.0 | 3.9 | 2.0 | 3.962 | 369.00 | 1390.00 |
| RHA120B80T6 | * | 120.0 | 80.0 | 6.0 | | 6.430 | 400.00 | 2256.0 |
| RHA125B30T2.5 | ✓ | 125.0 | 30.0 | 2.5 | | 2.138 | 310.00 | 750.00 |
| RHA125B40T3 | ✓ | 125.0 | 40.0 | 3.0 | | 2.719 | 329.20 | 954.00 |
| RHA125B50T3 | ✓ | 125.0 | 50.0 | 3.0 | | 2.890 | 349.14 | 1013.86 |
| RHA150B30T2.5 | ✓ | 150.0 | 30.0 | 2.5 | | 2.494 | 360.00 | 875.00 |
| RHA150B50T2.5 | * | 150.0 | 50.0 | 2.5 | | 2.779 | 400.00 | 975.00 |
| RHA150B50T3 | ✓ | 150.0 | 50.0 | 3.0 | | 3.317 | 400.00 | 1164.00 |
| RHA150B76T2.5 | * | 150.0 | 76.0 | 2.5 | | 3.149 | 452.00 | 1105.00 |
| RHA150B100T2.5 | ✓ | 150.0 | 100.0 | 2.5 | | 3.445 | 500.00 | 1208.92 |
| RHRA154.9B79.7T6R14.6 | * | 154.9 | 79.7 | 6.0 | 14.6 | 7.358 | 444.24 | 2581.72 |
| RHA160B60T4 | ✓ | 160.0 | 60.0 | 4.0 | | 4.834 | 440.00 | 1696.00 |
| RHA160B60T5 | * | 160.0 | 60.0 | 5.0 | | 5.985 | 440.00 | 2100.00 |
| RHRA160B148.5T6R10 | * | 160.0 | 148.5 | 6.0 | 10.0 | 9.935 | 599.83 | 3485.90 |
| RHRA160B150T6R10 | * | 160.0 | 150.0 | 6.0 | 10.0 | 9.986 | 602.83 | 3503.90 |
| RHRA169B86.2T6R15.1 | * | 169.0 | 86.2 | 6.0 | 15.1 | 8.026 | 484.57 | 2816.07 |
| RHA171B93T10 | * | 171.0 | 93.0 | 10.0 | | 13.959 | 527.14 | 4897.79 |
| RHA173B73T5 | * | 173.0 | 73.0 | 5.0 | | 6.726 | 492.00 | 2360.00 |
| RHRA174B86.6T7.5R5 | * | 174.0 | 86.6 | 7.5 | 5.0 | 10.450 | 512.62 | 3666.69 |
| RHA180B80T3 | ✓ | 180.0 | 80.0 | 3.0 | | 4.344 | 520.00 | 1524.10 |
| RHA200B30T2.8 | * | 200.0 | 30.0 | 2.8 | | 3.519 | 460.00 | 1234.75 |
| RHA200B50T3 | ✓ | 200.0 | 50.0 | 3.0 | | 4.172 | 500.00 | 1464.00 |
| RHA200B60T2 | * | 200.0 | 60.0 | 2.0 | | 2.918 | 520.00 | 1024.00 |
| RHA200B75T3 | ✓ | 200.0 | 75.0 | 3.0 | | 4.600 | 549.50 | 1614.00 |
| RHA200B100T3 | ✓ | 200.0 | 100.0 | 3.0 | | 5.027 | 600.00 | 1764.00 |
| RHA200B100T8 | ✓ | 200.0 | 100.0 | 8.0 | | 12.950 | 600.00 | 4544.00 |
| RHRA232B74T10R4 | * | 232.0 | 74.0 | 10.0 | 4.0 | 16.393 | 611.14 | 5751.79 |
| RHA250B50T3 | ✓ | 250.0 | 50.0 | 3.0 | | 5.027 | 600.00 | 1764.00 |
| RHA300B50T3 | ✓ | 300.0 | 50.0 | 3.0 | | 6.047 | 699.00 | 2121.87 |
| RHA317B220T16 | * | 317.0 | 220.0 | 16.0 | | 46.117 | 1074.00 | 16181.46 |

"✓" Stocked Item
 "✱" Pre-order Only Item
 (30-40 working days delivery)



Round Tubes

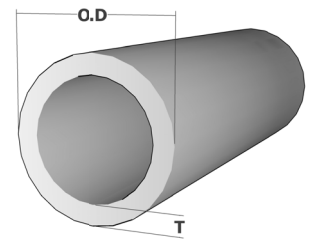

| Product Code | Ex Stock | O.D (mm) | T (mm) | Mass (kg/m) | Perimeter (mm) | Area (mm ²) |
|--------------|----------|----------|--------|-------------|----------------|-------------------------|
| RTD8T1.2 | ✱ | 8.0 | 1.2 | 0.073 | 25.13 | 25.65 |
| RTD8T1.5 | ✱ | 8.0 | 1.5 | 0.087 | 25.13 | 30.63 |
| RTD8.9T1.8 | ✱ | 8.9 | 1.8 | 0.114 | 27.95 | 40.15 |
| RTD8.9T1.55 | ✱ | 8.9 | 1.55 | 0.102 | 27.95 | 35.79 |
| RTD9T1.4 | ✱ | 9.0 | 1.4 | 0.095 | 28.27 | 33.43 |
| RTD9T2 | ✓ | 9.0 | 2.0 | 0.125 | 28.26 | 43.98 |
| RTD9.53T1.42 | ✱ | 9.5 | 0.9 | 0.069 | 29.85 | 24.32 |
| RTD9.53T1.42 | ✓ | 9.53 | 1.42 | 0.103 | 29.92 | 36.18 |
| RTD10T1 | ✱ | 10.0 | 1.0 | 0.081 | 31.40 | 28.27 |
| RTD10T1.2 | ✓ | 10.0 | 1.2 | 0.095 | 31.40 | 33.18 |
| RTD10T1.5 | ✱ | 10.0 | 1.5 | 0.114 | 31.42 | 40.01 |
| RTD10T2 | ✱ | 10.0 | 2.0 | 0.143 | 31.42 | 50.27 |
| RTD10.6T1.6 | ✱ | 10.6 | 1.6 | 0.129 | 33.28 | 45.21 |
| RTD11T0.7 | ✱ | 11.0 | 0.7 | 0.065 | 34.60 | 22.65 |
| RTD11T2 | ✱ | 11.0 | 2.0 | 0.161 | 34.56 | 56.55 |
| RTD11T3 | ✱ | 11.0 | 3.0 | 0.215 | 34.56 | 75.40 |
| RTD11.5T0.8 | ✱ | 11.5 | 0.8 | 0.077 | 36.11 | 26.88 |
| RTD11.8T0.55 | ✱ | 11.8 | 0.55 | 0.080 | 37.05 | 19.43 |
| RTD11.8T0.95 | ✱ | 11.8 | 0.95 | 0.092 | 37.07 | 32.38 |
| RTD12T0.8 | ✱ | 12.0 | 0.8 | 0.080 | 37.68 | 28.13 |
| RTD12T0.9 | ✱ | 12.0 | 0.9 | 0.089 | 37.68 | 31.37 |
| RTD12T1 | ✱ | 12.0 | 1.0 | 0.098 | 37.68 | 34.56 |
| RTD12T1.2 | ✱ | 12.0 | 1.2 | 0.116 | 37.68 | 40.69 |
| RTD12T2 | ✱ | 12.0 | 2.0 | 0.179 | 37.70 | 62.83 |
| RTD12T2.6 | ✱ | 12.0 | 2.6 | 0.219 | 37.70 | 76.78 |
| RTD12T2.6 | ✱ | 12.0 | 2.6 | 0.219 | 37.70 | 76.78 |
| RTD12T3.9 | ✱ | 12.0 | 3.9 | 0.283 | 37.70 | 99.24 |
| RTD12.4T0.8 | ✱ | 12.4 | 0.8 | 0.083 | 38.96 | 29.15 |
| RTD12.5T2 | ✱ | 12.5 | 2.0 | 0.188 | 39.27 | 65.97 |
| RTD12.7T1.4 | ✓ | 12.7 | 1.4 | 0.142 | 39.88 | 49.68 |
| RTD13T1 | ✱ | 13.0 | 1.0 | 0.107 | 40.84 | 37.70 |
| RTD13T1.1 | ✱ | 13.0 | 1.1 | 0.117 | 40.84 | 41.12 |
| RTD13T1.2 | ✱ | 13.0 | 1.2 | 0.349 | 40.84 | 44.49 |
| RTD13T1.4 | ✱ | 13.0 | 1.4 | 0.453 | 40.84 | 51.02 |
| RTD13T2 | ✱ | 13.0 | 2.0 | 0.500 | 40.84 | 69.12 |
| RTD13T4.7 | ✱ | 13.0 | 4.7 | 0.262 | 40.84 | 112.55 |
| RTD13.7T2 | ✱ | 13.7 | 2.0 | 0.209 | 43.02 | 73.48 |
| RTD13.8T0.5 | ✱ | 13.8 | 0.5 | 0.060 | 43.35 | 20.89 |
| RTD14T0.65 | ✱ | 14.0 | 0.65 | 0.078 | 43.96 | 27.25 |
| RTD14T0.7 | ✱ | 14.0 | 0.7 | 0.083 | 43.96 | 29.23 |

"✓" Stocked Item
 "✱" Pre-order Only Item
 (30-40 working days delivery)



Round Tubes

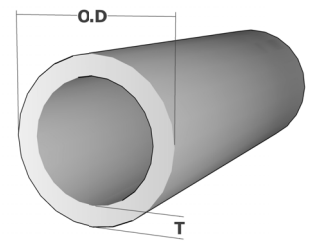

| Product Code | Ex Stock | O.D (mm) | T (mm) | Mass (kg/m) | Perimeter (mm) | Area (mm ²) |
|--------------|----------|----------|--------|-------------|----------------|-------------------------|
| RTD14T0.8 | ✱ | 14.0 | 0.8 | 0.095 | 43.96 | 33.16 |
| RTD14T0.9 | ✱ | 14.0 | 0.9 | 0.106 | 43.96 | 37.02 |
| RTD14T1.2 | ✱ | 14.0 | 1.2 | 0.138 | 43.96 | 48.26 |
| RTD14T1.5 | ✱ | 14.0 | 1.5 | 0.168 | 43.96 | 58.88 |
| RTD14T2 | ✓ | 14.0 | 2.0 | 0.215 | 44.00 | 75.40 |
| RTD14T3.6 | ✱ | 14.0 | 3.6 | 0.335 | 44.00 | 117.62 |
| RTD14.5T3.85 | ✱ | 14.5 | 3.85 | 0.367 | 45.55 | 128.81 |
| RTD14.8T1.2 | ✱ | 14.8 | 1.2 | 0.146 | 46.50 | 51.27 |
| RTD15T0.5 | ✱ | 15.0 | 0.5 | 0.065 | 47.12 | 22.78 |
| RTD15T0.65 | ✱ | 15.0 | 0.65 | 0.084 | 47.13 | 29.30 |
| RTD15T0.8 | ✱ | 15.0 | 0.8 | 0.102 | 47.10 | 35.67 |
| RTD15T1 | ✱ | 15.0 | 1.0 | 0.125 | 47.12 | 43.98 |
| RTD15T1.1 | ✱ | 15.0 | 1.1 | 0.137 | 47.13 | 48.04 |
| RTD15T1.2 | ✱ | 15.0 | 1.2 | 0.148 | 47.10 | 52.00 |
| RTD15T2 | ✱ | 15.0 | 2.0 | 0.233 | 47.13 | 81.68 |
| RTD15T1.41 | ✓ | 15.0 | 1.41 | 0.170 | 47.10 | 59.79 |
| RTD15T4.1 | ✱ | 15.0 | 4.1 | 0.400 | 47.13 | 140.40 |
| RTD16T0.6 | ✱ | 16.0 | 0.6 | 0.083 | 50.24 | 29.01 |
| RTD16T0.7 | ✱ | 16.0 | 0.7 | 0.096 | 50.27 | 33.65 |
| RTD16T0.8 | ✱ | 16.0 | 0.8 | 0.109 | 50.24 | 38.18 |
| RTD16T1 | ✱ | 16.0 | 1.0 | 0.134 | 50.24 | 47.10 |
| RTD16T1.1 | ✱ | 16.0 | 1.1 | 0.147 | 50.24 | 51.47 |
| RTD16T1.2 | ✱ | 16.0 | 1.2 | 0.159 | 50.24 | 55.77 |
| RTD16T1.3 | ✓ | 16.0 | 1.3 | 0.171 | 50.24 | 60.00 |
| RTD16T2 | ✱ | 16.0 | 2.0 | 0.251 | 50.27 | 88.00 |
| RTD16T3 | ✱ | 16.0 | 3.0 | 0.349 | 50.27 | 122.52 |
| RTD16T4 | ✱ | 16.0 | 4.0 | 0.430 | 50.27 | 150.80 |
| RTD16T4.6 | ✱ | 16.0 | 4.6 | 0.470 | 50.27 | 164.75 |
| RTD16.5T1.2 | ✱ | 16.5 | 1.2 | 0.164 | 51.81 | 57.65 |
| RTD17T1 | ✱ | 17.0 | 1.0 | 0.143 | 53.41 | 50.27 |
| RTD17T2 | ✱ | 17.0 | 2.0 | 0.269 | 53.41 | 94.25 |
| RTD17T3 | ✓ | 17.0 | 3.0 | 0.376 | 53.41 | 132.00 |
| RTD17T4 | ✱ | 17.0 | 4.0 | 0.466 | 53.41 | 163.36 |
| RTD17T5.1 | ✱ | 17.0 | 5.1 | 0.543 | 53.41 | 190.66 |
| RTD17T5.6 | ✱ | 17.0 | 5.6 | 0.572 | 53.41 | 200.56 |
| RTD17T5.9 | ✱ | 17.0 | 5.9 | 0.586 | 53.41 | 205.74 |
| RTD17.5T2 | ✱ | 17.5 | 2.0 | 0.277 | 54.99 | 97.39 |
| RTD18T1 | ✱ | 18.0 | 1.0 | 0.152 | 56.55 | 53.41 |
| RTD18T1.2 | ✱ | 18.0 | 1.2 | 0.180 | 56.52 | 63.34 |
| RTD18T1.5 | ✱ | 18.0 | 1.5 | 0.221 | 56.52 | 77.75 |

"✓" Stocked Item
 "✱" Pre-order Only Item
 (30-40 working days delivery)



Round Tubes

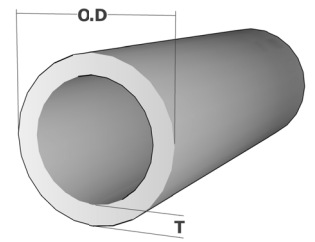

| Product Code | Ex Stock | O.D (mm) | T (mm) | Mass (kg/m) | Perimeter (mm) | Area (mm ²) |
|--------------|----------|----------|--------|-------------|----------------|-------------------------|
| RTD18T2 | ✱ | 18.0 | 2.0 | 0.287 | 56.55 | 100.53 |
| RTD18T3 | ✓ | 18.0 | 3.0 | 0.403 | 56.55 | 141.37 |
| RTD18T4 | ✱ | 18.0 | 4.0 | 0.502 | 56.55 | 176.00 |
| RTD18T5.6 | ✱ | 18.0 | 5.6 | 0.622 | 56.55 | 218.15 |
| RTD18T6.1 | ✱ | 18.0 | 6.1 | 0.650 | 56.55 | 228.05 |
| RTD18.5T6.65 | ✱ | 18.5 | 6.7 | 0.706 | 58.12 | 247.57 |
| RTD18.6T0.8 | ✱ | 18.6 | 0.8 | 0.128 | 58.43 | 44.80 |
| RTD19T0.6 | ✱ | 19.0 | 0.6 | 0.099 | 59.69 | 34.68 |
| RTD19T0.7 | ✱ | 19.0 | 0.7 | 0.115 | 59.66 | 40.22 |
| RTD19T0.8 | ✱ | 19.0 | 0.8 | 0.130 | 59.70 | 45.74 |
| RTD19T0.9 | ✱ | 19.0 | 0.9 | 0.146 | 59.66 | 51.15 |
| RTD19T1 | ✱ | 19.0 | 1.0 | 0.161 | 59.66 | 56.52 |
| RTD19T1.1 | ✱ | 19.0 | 1.1 | 0.176 | 59.66 | 61.83 |
| RTD19T1.2 | ✓ | 19.0 | 1.2 | 0.191 | 59.66 | 67.07 |
| RTD19T1.4 | ✓ | 19.0 | 1.4 | 0.221 | 59.66 | 77.37 |
| RTD19T1.5 | ✱ | 19.0 | 1.5 | 0.235 | 59.66 | 82.43 |
| RTD19T1.6 | ✓ | 19.0 | 1.6 | 0.249 | 59.66 | 87.42 |
| RTD19T1.85 | ✱ | 19.0 | 1.85 | 0.284 | 59.66 | 99.62 |
| RTD19T2 | ✓ | 19.0 | 2.0 | 0.304 | 59.66 | 106.76 |
| RTD19T3 | ✓ | 19.0 | 3.0 | 0.430 | 59.69 | 150.80 |
| RTD19T4 | ✱ | 19.0 | 4.0 | 0.537 | 60.00 | 188.50 |
| RTD19T6.1 | ✱ | 19.0 | 6.1 | 0.705 | 59.70 | 247.21 |
| RTD19T6.6 | ✱ | 19.0 | 6.6 | 0.733 | 59.70 | 257.11 |
| RTD19.2T1.5 | ✱ | 19.2 | 1.5 | 0.238 | 60.29 | 83.37 |
| RTD19.3T1.4 | ✱ | 19.3 | 1.4 | 0.224 | 60.60 | 78.69 |
| RTD20T0.7 | ✱ | 20.0 | 0.7 | 0.121 | 62.80 | 42.42 |
| RTD20T1 | ✱ | 20.0 | 1.0 | 0.170 | 62.80 | 59.66 |
| RTD20T1.2 | ✓ | 20.0 | 1.2 | 0.202 | 62.80 | 70.84 |
| RTD20T1.3 | ✱ | 20.0 | 1.3 | 0.218 | 62.80 | 76.37 |
| RTD20T1.5 | ✱ | 20.0 | 1.5 | 0.248 | 62.80 | 87.18 |
| RTD20T2 | ✱ | 20.0 | 2.0 | 0.322 | 62.83 | 113.10 |
| RTD20T3 | ✓ | 20.0 | 3.0 | 0.457 | 62.83 | 160.22 |
| RTD20T4 | ✱ | 20.0 | 4.0 | 0.573 | 62.83 | 201.06 |
| RTD20T6.6 | ✱ | 20.0 | 6.6 | 0.792 | 62.83 | 277.84 |
| RTD20T6.85 | ✱ | 20.0 | 6.85 | 0.807 | 62.80 | 282.99 |
| RTD20T7.1 | ✱ | 20.0 | 7.1 | 0.820 | 62.83 | 287.74 |
| RTD20.2T5.8 | ✱ | 20.2 | 5.8 | 0.748 | 63.43 | 262.39 |
| RTD20.5T1 | ✱ | 20.5 | 1.0 | 0.175 | 64.40 | 61.26 |
| RTD20.5T2 | ✱ | 20.5 | 2.0 | 0.331 | 64.40 | 116.24 |
| RTD21T0.8 | ✱ | 21.0 | 0.8 | 0.145 | 65.94 | 50.74 |

"✓" Stocked Item
 "✱" Pre-order Only Item
 (30-40 working days delivery)



Round Tubes

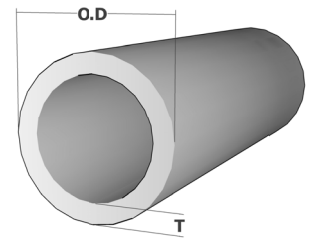

| Product Code | Ex Stock | O.D (mm) | T (mm) | Mass (kg/m) | Perimeter (mm) | Area (mm ²) |
|--------------|----------|----------|--------|-------------|----------------|-------------------------|
| RTD21T1 | ✱ | 21.0 | 1.0 | 0.179 | 66.00 | 62.83 |
| RTD21T2 | ✱ | 21.0 | 2.0 | 0.340 | 66.00 | 119.40 |
| RTD21T2.3 | ✱ | 21.0 | 2.3 | 0.385 | 65.94 | 135.05 |
| RTD21T2.5 | ✱ | 21.0 | 2.5 | 0.414 | 65.97 | 145.30 |
| RTD21T3 | ✱ | 21.0 | 3.0 | 0.484 | 66.00 | 169.65 |
| RTD21T4 | ✓ | 21.0 | 4.0 | 0.609 | 66.00 | 213.63 |
| RTD21T5 | ✱ | 21.0 | 5.0 | 0.716 | 66.00 | 251.33 |
| RTD21T7.1 | ✱ | 21.0 | 7.1 | 0.884 | 65.97 | 310.00 |
| RTD21T7.6 | ✱ | 21.0 | 7.6 | 0.912 | 66.00 | 319.94 |
| RTD21.5T2 | ✱ | 21.5 | 2.0 | 0.349 | 67.54 | 122.52 |
| RTD21.6T0.8 | ✱ | 21.6 | 0.8 | 0.149 | 67.86 | 52.34 |
| RTD21.7T0.65 | ✱ | 21.7 | 0.65 | 0.123 | 68.17 | 43.00 |
| RTD21.9T3 | ✱ | 21.9 | 3.0 | 0.507 | 68.77 | 178.04 |
| RTD21.8T0.8 | ✱ | 21.8 | 0.8 | 0.150 | 68.45 | 52.75 |
| RTD21.8T1 | ✱ | 21.8 | 1.0 | 0.186 | 68.45 | 65.34 |
| RTD22T0.7 | ✱ | 22.0 | 0.7 | 0.133 | 69.08 | 46.82 |
| RTD22T0.8 | ✱ | 22.0 | 0.8 | 0.152 | 69.12 | 53.30 |
| RTD22T0.9 | ✱ | 22.0 | 0.9 | 0.170 | 69.08 | 59.63 |
| RTD22T1 | ✓ | 22.0 | 1.0 | 0.188 | 69.12 | 65.94 |
| RTD22T1.1 | ✱ | 22.0 | 1.1 | 0.206 | 69.08 | 72.23 |
| RTD22T1.2 | ✱ | 22.0 | 1.2 | 0.223 | 69.08 | 78.37 |
| RTD22T1.4 | ✱ | 22.0 | 1.4 | 0.258 | 69.08 | 90.56 |
| RTD22T1.8 | ✱ | 22.0 | 1.8 | 0.325 | 69.08 | 114.17 |
| RTD22T2 | ✱ | 22.0 | 2.0 | 0.358 | 69.08 | 125.60 |
| RTD22T2.15 | ✱ | 22.0 | 2.15 | 0.382 | 69.08 | 134.01 |
| RTD22T2.6 | ✱ | 22.0 | 2.6 | 0.451 | 69.08 | 158.38 |
| RTD22T3 | ✓ | 22.0 | 3.0 | 0.510 | 69.11 | 179.10 |
| RTD22T4 | ✱ | 22.0 | 4.0 | 0.645 | 69.11 | 226.20 |
| RTD22T5 | ✱ | 22.0 | 5.0 | 0.761 | 69.11 | 267.00 |
| RTD22T8.1 | ✱ | 22.0 | 8.1 | 1.008 | 69.11 | 353.71 |
| RTD22.2T1.1 | ✱ | 22.2 | 1.1 | 0.208 | 69.71 | 72.88 |
| RTD22.5T1 | ✱ | 22.5 | 1.0 | 0.192 | 70.70 | 67.54 |
| RTD22.6T0.55 | ✱ | 22.6 | 0.55 | 0.109 | 71.00 | 38.10 |
| RTD22.8T1.3 | ✱ | 22.8 | 1.3 | 0.250 | 71.59 | 87.76 |
| RTD23T1 | ✱ | 23.0 | 1.0 | 0.197 | 72.26 | 69.11 |
| RTD23T2 | ✱ | 23.0 | 2.0 | 0.376 | 72.26 | 132.00 |
| RTD23T3 | ✓ | 23.0 | 3.0 | 0.537 | 72.26 | 188.50 |
| RTD23T4 | ✱ | 23.0 | 4.0 | 0.680 | 72.26 | 238.76 |
| RTD23T5 | ✱ | 23.0 | 5.0 | 0.806 | 72.26 | 282.74 |
| RTD23T8.6 | ✱ | 23.0 | 8.6 | 1.109 | 72.26 | 389.06 |

"✓" Stocked Item
 "✱" Pre-order Only Item
 (30-40 working days delivery)



Round Tubes

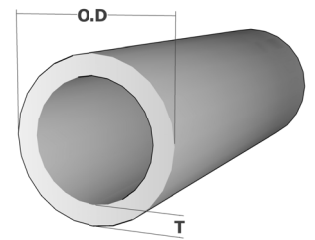

| Product Code | Ex Stock | O.D (mm) | T (mm) | Mass (kg/m) | Perimeter (mm) | Area (mm ²) |
|--------------|----------|----------|--------|-------------|----------------|-------------------------|
| RTD23.9T1 | ✱ | 23.9 | 1.0 | 0.205 | 75.05 | 71.91 |
| RTD24T1 | ✱ | 24.0 | 1.0 | 0.206 | 75.40 | 72.26 |
| RTD24T2 | ✓ | 24.0 | 2.0 | 0.394 | 75.40 | 138.23 |
| RTD24T2.5 | ✱ | 24.0 | 2.5 | 0.481 | 75.40 | 168.86 |
| RTD24T3 | ✱ | 24.0 | 3.0 | 0.564 | 75.40 | 197.92 |
| RTD24T4 | ✱ | 24.0 | 4.0 | 0.716 | 75.40 | 251.33 |
| RTD24T5 | ✱ | 24.0 | 5.0 | 0.851 | 75.40 | 298.45 |
| RTD24T6 | ✱ | 24.0 | 6.0 | 0.967 | 75.40 | 339.30 |
| RTD24T7 | ✱ | 24.0 | 7.0 | 1.065 | 75.40 | 373.85 |
| RTD24T9.1 | ✱ | 24.0 | 9.1 | 1.214 | 75.40 | 426.00 |
| RTD24.5T1.25 | ✱ | 24.5 | 1.25 | 0.260 | 77.00 | 91.30 |
| RTD24.5T2 | ✱ | 24.5 | 2.0 | 0.403 | 76.97 | 141.37 |
| RTD24.8T1.7 | ✱ | 24.8 | 1.7 | 0.352 | 77.90 | 123.40 |
| RTD24.8T1.9 | ✱ | 24.8 | 1.9 | 0.389 | 77.87 | 136.62 |
| RTD24.8T1.1 | ✱ | 24.8 | 1.1 | 0.234 | 78.19 | 82.21 |
| RTD24.9T1.2 | ✱ | 24.9 | 1.2 | 0.255 | 78.19 | 89.30 |
| RTD25T0.7 | ✱ | 25.0 | 0.7 | 0.152 | 78.54 | 53.44 |
| RTD25T0.8 | ✱ | 25.0 | 0.8 | 0.173 | 78.50 | 60.79 |
| RTD25T0.9 | ✱ | 25.0 | 0.9 | 0.194 | 78.50 | 68.11 |
| RTD25T1 | ✱ | 25.0 | 1.0 | 0.215 | 78.50 | 75.36 |
| RTD25T1.1 | ✱ | 25.0 | 1.1 | 0.235 | 78.50 | 82.55 |
| RTD25T1.2 | ✱ | 25.0 | 1.2 | 0.256 | 78.50 | 89.68 |
| RTD25T1.4 | ✱ | 25.0 | 1.4 | 0.296 | 78.50 | 103.75 |
| RTD25T1.5 | ✱ | 25.0 | 1.5 | 0.315 | 78.50 | 110.69 |
| RTD25T1.8 | ✱ | 25.0 | 1.8 | 0.374 | 78.50 | 131.13 |
| RTD25T1.9 | ✓ | 25.0 | 1.9 | 0.393 | 78.50 | 137.82 |
| RTD25T2 | ✱ | 25.0 | 2.0 | 0.412 | 78.54 | 144.51 |
| RTD25T2.5 | ✱ | 25.0 | 2.5 | 0.503 | 78.50 | 176.63 |
| RTD25T3 | ✓ | 25.0 | 3.0 | 0.591 | 78.50 | 207.24 |
| RTD25T4 | ✱ | 25.0 | 4.0 | 0.752 | 78.54 | 263.90 |
| RTD25T5 | ✱ | 25.0 | 5.0 | 0.895 | 78.50 | 314.00 |
| RTD25T5.5 | ✱ | 25.0 | 5.5 | 0.960 | 78.54 | 336.94 |
| RTD25T6 | ✱ | 25.0 | 6.0 | 1.020 | 78.50 | 357.96 |
| RTD25T7.3 | ✱ | 25.0 | 7.3 | 1.156 | 78.50 | 405.72 |
| RTD25T8.25 | ✱ | 25.0 | 8.25 | 1.237 | 78.50 | 433.91 |
| RTD25T9.1 | ✱ | 25.0 | 9.1 | 1.295 | 78.50 | 454.33 |
| RTD25T9.6 | ✱ | 25.0 | 9.6 | 1.324 | 78.50 | 464.45 |
| RTD25.4T1 | ✱ | 25.4 | 1.0 | 0.218 | 79.76 | 76.62 |
| RTD25.4T1.2 | ✓ | 25.4 | 1.2 | 0.260 | 79.76 | 91.19 |
| RTD25.4T2.8 | ✱ | 25.4 | 2.8 | 0.566 | 79.76 | 198.70 |

"✓" Stocked Item
 "✱" Pre-order Only Item
 (30-40 working days delivery)



Round Tubes

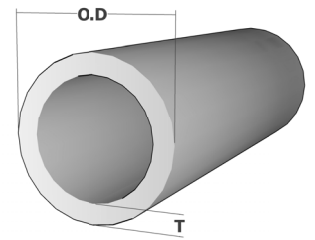

| Product Code | Ex Stock | O.D (mm) | T (mm) | Mass (kg/m) | Perimeter (mm) | Area (mm ²) |
|--------------|----------|----------|--------|-------------|----------------|-------------------------|
| RTD25.5T1 | ✱ | 25.5 | 1.0 | 0.219 | 80.11 | 77.00 |
| RTD25.5T2 | ✱ | 25.5 | 2.0 | 0.421 | 80.11 | 147.66 |
| RTD25.6T1.4 | ✱ | 25.6 | 1.4 | 0.303 | 80.38 | 106.38 |
| RTD25.9T1.3 | ✱ | 25.9 | 1.3 | 0.286 | 81.33 | 100.42 |
| RTD26T1 | ✱ | 26.0 | 1.0 | 0.224 | 81.68 | 78.54 |
| RTD26T2 | ✱ | 26.0 | 2.0 | 0.430 | 81.68 | 150.80 |
| RTD26T3 | ✓ | 26.0 | 3.0 | 0.617 | 81.68 | 216.66 |
| RTD26T4 | ✱ | 26.0 | 4.0 | 0.788 | 81.68 | 276.46 |
| RTD26T5 | ✱ | 26.0 | 5.0 | 0.940 | 81.68 | 329.87 |
| RTD26T7 | ✱ | 26.0 | 7.0 | 1.191 | 81.68 | 417.83 |
| RTD26T8.7 | ✱ | 26.0 | 8.7 | 1.347 | 81.64 | 472.60 |
| RTD26T10.1 | ✱ | 26.0 | 10.1 | 1.438 | 81.68 | 504.51 |
| RTD26.2T1.7 | ✱ | 26.2 | 1.7 | 0.373 | 82.27 | 130.78 |
| RTD26.3T2 | ✱ | 26.3 | 2.0 | 0.435 | 82.58 | 152.60 |
| RTD27T0.7 | ✱ | 27.0 | 0.7 | 0.165 | 84.82 | 57.84 |
| RTD27T1 | ✱ | 27.0 | 1.0 | 0.233 | 84.82 | 81.68 |
| RTD27T1.2 | ✱ | 27.0 | 1.2 | 0.277 | 84.78 | 97.21 |
| RTD27T2 | ✱ | 27.0 | 2.0 | 0.448 | 84.82 | 157.10 |
| RTD27T2.2 | ✱ | 27.0 | 2.2 | 0.489 | 84.78 | 171.41 |
| RTD27T3 | ✓ | 27.0 | 3.0 | 0.645 | 84.82 | 226.20 |
| RTD27T4 | ✱ | 27.0 | 4.0 | 0.823 | 84.78 | 288.88 |
| RTD27T5 | ✱ | 27.0 | 5.0 | 0.985 | 84.82 | 345.58 |
| RTD27T10.6 | ✱ | 27.0 | 10.6 | 1.556 | 84.80 | 546.14 |
| RTD27.2T4.5 | ✱ | 27.2 | 4.5 | 0.914 | 85.41 | 320.75 |
| RTD27.5T1 | ✱ | 27.5 | 1.0 | 0.237 | 86.40 | 83.25 |
| RTD27.5T2 | ✱ | 27.5 | 2.0 | 0.457 | 86.40 | 160.22 |
| RTD27.6T1.3 | ✱ | 27.6 | 1.3 | 0.306 | 86.70 | 107.41 |
| RTD27.8T1 | ✱ | 27.8 | 1.0 | 0.240 | 87.30 | 84.20 |
| RTD27.9T0.55 | ✱ | 27.9 | 0.55 | 0.135 | 87.61 | 47.23 |
| RTD28T0.8 | ✱ | 28.0 | 0.8 | 0.195 | 87.92 | 68.33 |
| RTD28T1 | ✱ | 28.0 | 1.0 | 0.242 | 87.92 | 84.78 |
| RTD28T1.1 | ✱ | 28.0 | 1.1 | 0.265 | 87.92 | 92.91 |
| RTD28T1.5 | ✱ | 28.0 | 1.5 | 0.356 | 87.92 | 124.82 |
| RTD28T1.8 | ✱ | 28.0 | 1.8 | 0.422 | 87.92 | 148.08 |
| RTD28T2 | ✱ | 28.0 | 2.0 | 0.466 | 88.00 | 163.36 |
| RTD28T2.2 | ✱ | 28.0 | 2.2 | 0.508 | 88.00 | 178.32 |
| RTD28T3 | ✱ | 28.0 | 3.0 | 0.672 | 88.00 | 235.62 |
| RTD28T3.2 | ✱ | 28.0 | 3.2 | 0.710 | 87.92 | 249.19 |
| RTD28T4 | ✓ | 28.0 | 4.0 | 0.859 | 87.92 | 301.44 |
| RTD28T5 | ✱ | 28.0 | 5.0 | 1.030 | 88.00 | 361.28 |

"✓" Stocked Item
 "✱" Pre-order Only Item
 (30-40 working days delivery)



Round Tubes

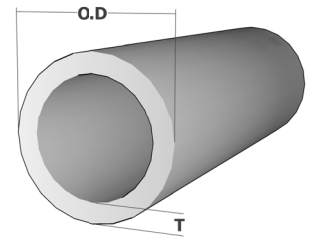

| Product Code | Ex Stock | O.D (mm) | T (mm) | Mass (kg/m) | Perimeter (mm) | Area (mm ²) |
|--------------|----------|----------|--------|-------------|----------------|-------------------------|
| RTD28T6.9 | ✱ | 28.0 | 6.9 | 1.304 | 88.00 | 457.39 |
| RTD28T11.1 | ✱ | 28.0 | 11.1 | 1.680 | 88.00 | 589.33 |
| RTD28.3T1 | ✱ | 28.3 | 1.0 | 0.244 | 88.86 | 85.72 |
| RTD28.5T2.2 | ✱ | 28.5 | 2.2 | 0.518 | 89.49 | 181.68 |
| RTD28.6T0.8 | ✱ | 28.6 | 0.8 | 0.199 | 89.80 | 69.90 |
| RTD28.7T2.5 | ✓ | 28.7 | 2.5 | 0.586 | 90.12 | 205.67 |
| RTD29T0.75 | ✱ | 29.0 | 0.75 | 0.190 | 91.11 | 66.56 |
| RTD29T1.1 | ✱ | 29.0 | 1.1 | 0.275 | 91.06 | 96.37 |
| RTD29T2 | ✱ | 29.0 | 2.0 | 0.484 | 91.11 | 169.65 |
| RTD29T3 | ✱ | 29.0 | 3.0 | 0.699 | 91.11 | 245.10 |
| RTD29T4 | ✱ | 29.0 | 4.0 | 0.895 | 91.11 | 314.20 |
| RTD29T5 | ✱ | 29.0 | 5.0 | 1.074 | 91.11 | 377.00 |
| RTD29T11.6 | ✱ | 29.0 | 11.6 | 1.807 | 91.11 | 634.10 |
| RTD29.4T1.7 | ✱ | 29.4 | 1.7 | 0.421 | 92.32 | 147.86 |
| RTD29.8T1.9 | ✱ | 29.8 | 1.9 | 0.474 | 93.57 | 166.45 |
| RTD30T1 | ✱ | 30.0 | 1.0 | 0.260 | 94.20 | 91.06 |
| RTD30T1.25 | ✱ | 30.0 | 1.25 | 0.322 | 94.25 | 112.90 |
| RTD30T1.5 | ✓ | 30.0 | 1.5 | 0.383 | 94.20 | 134.34 |
| RTD30T2 | ✱ | 30.0 | 2.0 | 0.501 | 94.25 | 175.93 |
| RTD30T3 | ✓ | 30.0 | 3.0 | 0.725 | 94.20 | 254.34 |
| RTD30T4 | ✱ | 30.0 | 4.0 | 0.931 | 94.25 | 326.73 |
| RTD30T5 | ✱ | 30.0 | 5.0 | 1.119 | 94.25 | 392.70 |
| RTD30T12.1 | ✱ | 30.0 | 12.1 | 1.939 | 94.25 | 680.44 |
| RTD30.5T2.5 | ✱ | 30.5 | 2.5 | 0.627 | 95.82 | 219.91 |
| RTD31T2 | ✱ | 31.0 | 2.0 | 0.519 | 97.40 | 182.21 |
| RTD31T3 | ✱ | 31.0 | 3.0 | 0.752 | 97.40 | 263.90 |
| RTD31T3.25 | ✱ | 31.0 | 3.25 | 0.807 | 97.34 | 283.19 |
| RTD31T4 | ✱ | 31.0 | 4.0 | 0.967 | 97.40 | 339.29 |
| RTD31T5 | ✓ | 31.0 | 5.0 | 1.164 | 97.40 | 408.40 |
| RTD31T12.6 | ✱ | 31.0 | 12.6 | 2.076 | 97.40 | 728.35 |
| RTD31.5T2 | ✱ | 31.5 | 2.0 | 0.528 | 98.91 | 185.26 |
| RTD31.5T3 | ✱ | 31.5 | 3.0 | 0.765 | 98.91 | 268.47 |
| RTD31.6T1.8 | ✱ | 31.6 | 1.8 | 0.480 | 99.22 | 168.43 |
| RTD31.8T3.15 | ✱ | 31.8 | 3.15 | 0.808 | 99.85 | 283.38 |
| RTD32T0.8 | ✱ | 32.0 | 0.8 | 0.223 | 100.48 | 78.37 |
| RTD32T1.2 | ✱ | 32.0 | 1.2 | 0.331 | 100.48 | 116.05 |
| RTD32T1.4 | ✱ | 32.0 | 1.4 | 0.383 | 100.48 | 134.52 |
| RTD32T1.5 | ✱ | 32.0 | 1.5 | 0.409 | 100.48 | 143.66 |
| RTD32T1.6 | ✓ | 32.0 | 1.6 | 0.435 | 100.48 | 152.73 |
| RTD32T2 | ✱ | 32.0 | 2.0 | 0.537 | 100.48 | 188.40 |

"✓" Stocked Item
 "✱" Pre-order Only Item
 (30-40 working days delivery)



Round Tubes

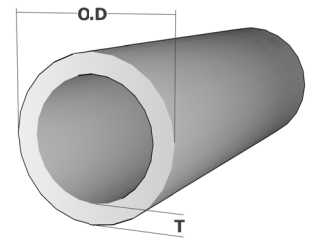

| Product Code | Ex Stock | O.D (mm) | T (mm) | Mass (kg/m) | Perimeter (mm) | Area (mm ²) |
|--------------|----------|----------|--------|-------------|----------------|-------------------------|
| RTD32T2.5 | ✱ | 32.0 | 2.5 | 0.660 | 100.48 | 231.58 |
| RTD32T3 | ✓ | 32.0 | 3.0 | 0.779 | 100.48 | 273.18 |
| RTD32T3.2 | ✱ | 32.0 | 3.2 | 0.825 | 100.48 | 289.38 |
| RTD32T4 | ✱ | 32.0 | 4.0 | 1.003 | 100.53 | 351.86 |
| RTD32T5 | ✱ | 32.0 | 5.0 | 1.208 | 100.48 | 423.90 |
| RTD32T7 | ✱ | 32.0 | 7.0 | 1.566 | 100.48 | 549.50 |
| RTD32T8 | ✱ | 32.0 | 8.0 | 1.719 | 100.53 | 603.19 |
| RTD32T13.1 | ✱ | 32.0 | 13.1 | 2.217 | 100.31 | 777.83 |
| RTD32.6T1.2 | ✱ | 32.6 | 1.2 | 0.337 | 102.36 | 118.32 |
| RTD33T2 | ✱ | 33.0 | 2.0 | 0.555 | 103.67 | 194.78 |
| RTD33T3 | ✱ | 33.0 | 3.0 | 0.806 | 103.67 | 282.74 |
| RTD33T4 | ✱ | 33.0 | 4.0 | 1.039 | 103.67 | 364.42 |
| RTD33T5 | ✱ | 33.0 | 5.0 | 1.253 | 103.67 | 439.80 |
| RTD33T13.6 | ✱ | 33.0 | 13.6 | 2.362 | 103.67 | 828.88 |
| RTD33.8T4.8 | ✓ | 33.8 | 4.8 | 1.246 | 106.13 | 437.09 |
| RTD34T1 | ✱ | 34.0 | 1.0 | 0.295 | 106.76 | 103.62 |
| RTD34T1.8 | ✱ | 34.0 | 1.8 | 0.519 | 106.76 | 181.99 |
| RTD34T2 | ✱ | 34.0 | 2.0 | 0.573 | 106.76 | 200.96 |
| RTD34T2.5 | ✱ | 34.0 | 2.5 | 0.705 | 106.80 | 247.40 |
| RTD34T3 | ✱ | 34.0 | 3.0 | 0.832 | 106.76 | 292.02 |
| RTD34T4 | ✱ | 34.0 | 4.0 | 1.074 | 106.76 | 376.80 |
| RTD34T5 | ✓ | 34.0 | 5.0 | 1.298 | 106.81 | 455.53 |
| RTD35T0.55 | ✱ | 35.0 | 0.55 | 0.170 | 109.96 | 59.53 |
| RTD35T0.6 | ✱ | 35.0 | 0.6 | 0.185 | 109.90 | 64.81 |
| RTD35T0.75 | ✱ | 35.0 | 0.75 | 0.230 | 109.90 | 80.66 |
| RTD35T1.1 | ✱ | 35.0 | 1.1 | 0.334 | 109.90 | 117.09 |
| RTD35T1.5 | ✱ | 35.0 | 1.5 | 0.450 | 109.90 | 157.79 |
| RTD35T1.8 | ✱ | 35.0 | 1.8 | 0.535 | 109.90 | 187.65 |
| RTD35T2 | ✱ | 35.0 | 2.0 | 0.591 | 109.90 | 207.24 |
| RTD35T4 | ✱ | 35.0 | 4.0 | 1.110 | 110.00 | 389.56 |
| RTD35T5 | ✱ | 35.0 | 5.0 | 1.343 | 110.00 | 471.24 |
| RTD35T6.5 | ✱ | 35.0 | 6.5 | 1.658 | 109.90 | 581.67 |
| RTD35T12.3 | ✱ | 35.0 | 12.3 | 2.499 | 109.90 | 876.72 |
| RTD35.2T0.8 | ✱ | 35.2 | 0.8 | 0.246 | 110.53 | 86.41 |
| RTD35.4T1.4 | ✱ | 35.4 | 1.4 | 0.426 | 111.16 | 149.46 |
| RTD35.5T0.8 | ✱ | 35.5 | 0.8 | 0.248 | 111.47 | 87.17 |
| RTD35.5T0.9 | ✱ | 35.5 | 0.9 | 0.279 | 111.47 | 97.78 |
| RTD35.5T1.2 | ✱ | 35.5 | 1.2 | 0.368 | 111.47 | 129.24 |
| RTD35.8T2 | ✱ | 35.8 | 2.0 | 0.605 | 112.41 | 212.26 |
| RTD36T0.8 | ✱ | 36.0 | 0.8 | 0.252 | 113.04 | 88.42 |

"✓" Stocked Item
 "✱" Pre-order Only Item
 (30-40 working days delivery)



Round Tubes

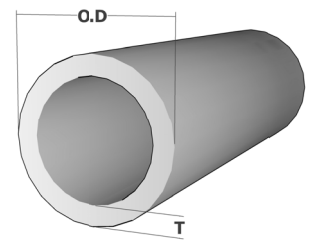

| Product Code | Ex Stock | O.D (mm) | T (mm) | Mass (kg/m) | Perimeter (mm) | Area (mm ²) |
|---------------|----------|----------|--------|-------------|----------------|-------------------------|
| RTD36T1.2 | ✱ | 36.0 | 1.2 | 0.374 | 113.04 | 131.13 |
| RTD36T1.25 | ✱ | 36.0 | 1.25 | 0.389 | 113.10 | 136.46 |
| RTD36T2 | ✓ | 36.0 | 2.0 | 0.609 | 113.10 | 213.63 |
| RTD36T4 | ✱ | 36.0 | 4.0 | 1.146 | 113.10 | 402.12 |
| RTD36T5 | ✱ | 36.0 | 5.0 | 1.388 | 113.10 | 487.00 |
| RTD36.5T8.75 | ✱ | 36.5 | 8.75 | 2.174 | 114.67 | 762.82 |
| RTD36.7T1.1 | ✱ | 36.7 | 1.1 | 0.350 | 115.24 | 122.96 |
| RTD37T13.4 | ✱ | 37.0 | 13.4 | 2.830 | 116.18 | 992.99 |
| RTD37T5 | ✱ | 37.0 | 5.0 | 1.433 | 116.24 | 502.66 |
| RTD38T1 | ✱ | 38.0 | 1.0 | 0.331 | 119.32 | 116.18 |
| RTD38T1.1 | ✱ | 38.0 | 1.1 | 0.363 | 119.32 | 127.45 |
| RTD38T1.4 | ✓ | 38.0 | 1.4 | 0.459 | 119.32 | 160.89 |
| RTD38T1.8 | ✱ | 38.0 | 1.8 | 0.583 | 119.32 | 204.60 |
| RTD38T2.5 | ✱ | 38.0 | 2.5 | 0.794 | 119.32 | 278.68 |
| RTD38T2.9 | ✱ | 38.0 | 2.9 | 0.911 | 119.32 | 319.62 |
| RTD38T3 | ✓ | 38.0 | 3.0 | 0.940 | 119.32 | 329.70 |
| RTD38T3.5 | ✱ | 38.0 | 3.5 | 1.081 | 119.32 | 379.16 |
| RTD38T8 | ✱ | 38.0 | 8.0 | 2.149 | 119.32 | 753.98 |
| RTD38.1T3 | ✱ | 38.1 | 3.0 | 0.942 | 119.63 | 330.64 |
| RTD38.4T1.1 | ✱ | 38.4 | 1.1 | 0.367 | 120.58 | 128.83 |
| RTD39T1.05 | ✱ | 39.0 | 1.05 | 0.357 | 122.46 | 125.12 |
| RTD39T4 | ✱ | 39.0 | 4.0 | 1.253 | 122.46 | 439.60 |
| RTD39.12T1.36 | ✱ | 39.12 | 1.36 | 0.460 | 122.90 | 161.50 |
| RTD40T0.9 | ✱ | 40.0 | 0.9 | 0.315 | 125.66 | 110.55 |
| RTD40T1.05 | ✱ | 40.0 | 1.05 | 0.366 | 125.60 | 128.42 |
| RTD40T1.25 | ✱ | 40.0 | 1.25 | 0.434 | 125.70 | 152.17 |
| RTD40T1.5 | ✱ | 40.0 | 1.5 | 0.517 | 125.60 | 181.34 |
| RTD40T2 | ✱ | 40.0 | 2.0 | 0.680 | 125.66 | 238.76 |
| RTD40T3 | ✱ | 40.0 | 3.0 | 0.994 | 125.66 | 348.72 |
| RTD40T4 | ✓ | 40.0 | 4.0 | 1.289 | 125.66 | 452.16 |
| RTD40T5 | ✱ | 40.0 | 5.0 | 1.567 | 125.66 | 549.78 |
| RTD40.5T0.8 | ✱ | 40.5 | 0.8 | 0.284 | 127.80 | 99.73 |
| RTD40.7T0.75 | ✱ | 40.7 | 0.75 | 0.268 | 127.80 | 94.08 |
| RTD41T0.8 | ✱ | 41.0 | 0.8 | 0.288 | 128.74 | 100.98 |
| RTD41T0.9 | ✱ | 41.0 | 0.9 | 0.323 | 128.74 | 113.32 |
| RTD41T1.2 | ✱ | 41.0 | 1.2 | 0.427 | 128.74 | 149.97 |
| RTD41T1.5 | ✱ | 41.0 | 1.5 | 0.530 | 128.74 | 186.14 |
| RTD41T4 | ✱ | 41.0 | 4.0 | 1.325 | 128.74 | 465.00 |
| RTD41T5 | ✱ | 41.0 | 5.0 | 1.611 | 128.74 | 565.20 |
| RTD41.8T0.8 | ✱ | 41.8 | 0.8 | 0.294 | 131.25 | 102.99 |

"✓" Stocked Item
 "✱" Pre-order Only Item
 (30-40 working days delivery)



Round Tubes

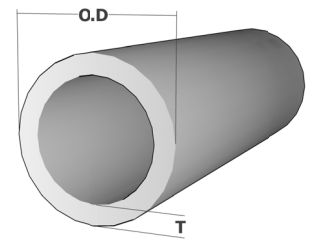

| Product Code | Ex Stock | O.D (mm) | T (mm) | Mass (kg/m) | Perimeter (mm) | Area (mm ²) |
|--------------|----------|----------|--------|-------------|----------------|-------------------------|
| RTD41.8T2.8 | ✱ | 41.8 | 2.8 | 0.977 | 131.25 | 342.89 |
| RTD42T1.1 | ✱ | 42.0 | 1.1 | 0.403 | 131.88 | 141.27 |
| RTD42T1.2 | ✱ | 42.0 | 1.2 | 0.438 | 131.88 | 153.73 |
| RTD42T1.4 | ✱ | 42.0 | 1.4 | 0.509 | 131.88 | 178.48 |
| RTD42T9 | ✱ | 42.0 | 9.0 | 2.658 | 131.88 | 932.58 |
| RTD43T1.5 | ✱ | 43.0 | 1.5 | 0.557 | 135.02 | 195.47 |
| RTD43T2 | ✱ | 43.0 | 2.0 | 0.734 | 135.02 | 257.48 |
| RTD43T2.5 | ✱ | 43.0 | 2.5 | 0.906 | 135.02 | 317.93 |
| RTD43T3 | ✱ | 43.0 | 3.0 | 1.074 | 135.02 | 376.80 |
| RTD43.3T2.8 | ✱ | 43.3 | 2.8 | 1.015 | 135.96 | 356.08 |
| RTD43.5T0.6 | ✱ | 43.5 | 0.6 | 0.230 | 136.66 | 80.86 |
| RTD44T1.25 | ✱ | 44.0 | 1.25 | 0.478 | 138.20 | 167.88 |
| RTD44T3.2 | ✱ | 44.0 | 3.2 | 1.168 | 138.16 | 409.96 |
| RTD45T1 | ✱ | 45.0 | 1.0 | 0.394 | 141.30 | 138.16 |
| RTD45T1.15 | ✱ | 45.0 | 1.15 | 0.451 | 141.30 | 158.34 |
| RTD45T1.35 | ✱ | 45.0 | 1.35 | 0.527 | 141.30 | 185.03 |
| RTD45T1.6 | ✱ | 45.0 | 1.6 | 0.621 | 141.30 | 218.04 |
| RTD45T3 | ✓ | 45.0 | 3.0 | 1.128 | 141.30 | 395.64 |
| RTD47T5 | ✱ | 47.0 | 5.0 | 1.879 | 147.58 | 659.40 |
| RTD48T1.25 | ✱ | 48.0 | 1.25 | 0.523 | 150.80 | 183.59 |
| RTD48T1.5 | ✓ | 48.0 | 1.5 | 0.624 | 150.72 | 219.02 |
| RTD48.4T2.6 | ✓ | 48.4 | 2.6 | 1.066 | 151.98 | 373.91 |
| RTD49.5T0.8 | ✱ | 49.5 | 0.8 | 0.349 | 155.43 | 122.33 |
| RTD49.5T1.4 | ✱ | 49.5 | 1.4 | 0.603 | 155.43 | 211.45 |
| RTD49.5T1.5 | ✱ | 49.5 | 1.5 | 0.644 | 155.43 | 226.08 |
| RTD49.7T3 | ✱ | 49.7 | 3.0 | 1.254 | 156.06 | 439.91 |
| RTD49.8T1.9 | ✓ | 49.8 | 1.9 | 0.814 | 156.37 | 285.77 |
| RTD50T1 | ✱ | 50.0 | 1.0 | 0.439 | 157.00 | 153.86 |
| RTD50T1.2 | ✱ | 50.0 | 1.2 | 0.524 | 157.00 | 183.88 |
| RTD50T1.4 | ✱ | 50.0 | 1.4 | 0.609 | 157.00 | 213.65 |
| RTD50T1.5 | ✱ | 50.0 | 1.5 | 0.651 | 157.00 | 228.44 |
| RTD50T2.5 | ✱ | 50.0 | 2.5 | 1.063 | 157.00 | 372.88 |
| RTD50T2.7 | ✱ | 50.0 | 2.7 | 1.143 | 157.00 | 401.01 |
| RTD50T2.8 | ✱ | 50.0 | 2.8 | 1.183 | 157.00 | 414.98 |
| RTD50T3 | ✓ | 50.0 | 3.0 | 1.262 | 157.00 | 442.74 |
| RTD50T3.5 | ✱ | 50.0 | 3.5 | 1.456 | 157.00 | 511.29 |
| RTD50T3.8 | ✱ | 50.0 | 3.8 | 1.571 | 157.00 | 551.26 |
| RTD50T4 | ✓ | 50.0 | 4.0 | 1.647 | 157.00 | 577.76 |
| RTD50T5 | ✓ | 50.0 | 5.0 | 2.014 | 157.00 | 706.50 |
| RTD50T5.5 | ✱ | 50.0 | 5.5 | 2.190 | 157.00 | 768.52 |

"✓" Stocked Item
 "*" Pre-order Only Item
 (30-40 working days delivery)



Round Tubes

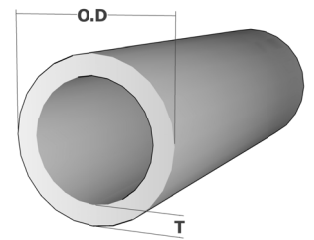

| Product Code | Ex Stock | O.D (mm) | T (mm) | Mass (kg/m) | Perimeter (mm) | Area (mm ²) |
|--------------|----------|----------|--------|-------------|----------------|-------------------------|
| RTD50T9.7 | * | 50.0 | 9.7 | 3.498 | 157.00 | 1227.46 |
| RTD50.8T3.0 | * | 50.8 | 3.0 | 1.284 | 159.59 | 450.50 |
| RTD51.5T2.5 | * | 51.5 | 2.5 | 1.097 | 161.79 | 384.85 |
| RTD52T1.25 | * | 52.0 | 1.25 | 0.568 | 163.40 | 199.29 |
| RTD53.8T0.6 | * | 53.8 | 0.6 | 0.286 | 169.00 | 100.28 |
| RTD54T0.7 | * | 54.0 | 0.7 | 0.334 | 169.56 | 117.15 |
| RTD54.5T3.2 | * | 54.5 | 3.2 | 1.469 | 171.13 | 515.46 |
| RTD56T1.25 | * | 56.0 | 1.25 | 0.613 | 175.90 | 215.00 |
| RTD56T15.5 | * | 56.0 | 15.5 | 5.621 | 175.93 | 1972.14 |
| RTD56.5T3 | * | 56.5 | 3.0 | 1.437 | 177.50 | 1972.14 |
| RTD57T4 | ✓ | 57.0 | 4.0 | 1.897 | 178.98 | 665.68 |
| RTD59.7T3 | * | 59.7 | 3.0 | 1.522 | 187.46 | 534.11 |
| RTD60T1.25 | * | 60.0 | 1.25 | 0.658 | 188.50 | 230.71 |
| RTD60T1.5 | * | 60.0 | 1.5 | 0.785 | 188.40 | 275.54 |
| RTD60T5 | ✓ | 60.0 | 5.0 | 2.461 | 188.40 | 863.50 |
| RTD60T9 | * | 60.0 | 9.0 | 4.110 | 188.50 | 1442.00 |
| RTD60.9T8 | * | 60.9 | 8.0 | 3.789 | 190.32 | 1329.52 |
| RTD63T1.5 | * | 63.0 | 1.5 | 0.826 | 197.82 | 289.67 |
| RTD63T6.5 | ✓ | 63.0 | 6.5 | 3.288 | 197.92 | 1153.75 |
| RTD63.5T3 | * | 63.5 | 3.0 | 1.625 | 199.49 | 570.20 |
| RTD64T0.8 | * | 64.0 | 0.8 | 0.452 | 200.96 | 158.76 |
| RTD64T1.25 | * | 64.0 | 1.25 | 0.702 | 201.10 | 246.42 |
| RTD67.4T0.7 | * | 67.4 | 0.7 | 0.418 | 211.74 | 146.68 |
| RTD68T1.25 | * | 68.0 | 1.25 | 0.747 | 213.60 | 262.13 |
| RTD70T2 | * | 70.0 | 2.0 | 1.217 | 219.80 | 427.04 |
| RTD70T4 | ✓ | 70.0 | 4.0 | 2.363 | 219.80 | 828.96 |
| RTD72T0.8 | * | 72.0 | 0.8 | 0.510 | 226.08 | 178.85 |
| RTD72T1.25 | * | 72.0 | 1.25 | 0.792 | 226.20 | 277.83 |
| RTD75T1.8 | ✓ | 75.0 | 1.8 | 1.180 | 235.60 | 413.90 |
| RTD75T3 | ✓ | 75.0 | 3.0 | 1.933 | 235.50 | 678.24 |
| RTD76T0.61 | * | 76.0 | 0.61 | 0.412 | 238.76 | 144.48 |
| RTD76T0.72 | * | 76.0 | 0.72 | 0.485 | 238.76 | 170.28 |
| RTD76T0.77 | * | 76.0 | 0.77 | 0.519 | 238.76 | 181.98 |
| RTD76T0.8 | * | 76.0 | 0.8 | 0.538 | 238.64 | 188.90 |
| RTD76T0.9 | * | 76.0 | 0.9 | 0.605 | 238.64 | 212.23 |
| RTD76T1 | * | 76.0 | 1.0 | 0.671 | 238.64 | 235.50 |
| RTD76T1.2 | * | 76.0 | 1.2 | 0.803 | 238.64 | 281.85 |
| RTD76T1.4 | * | 76.0 | 1.4 | 0.935 | 238.64 | 327.94 |
| RTD76T1.5 | * | 76.0 | 1.5 | 1.000 | 238.64 | 350.90 |
| RTD76T4 | ✓ | 76.0 | 4.0 | 2.577 | 238.64 | 904.32 |

"✓" Stocked Item
 "*" Pre-order Only Item
 (30-40 working days delivery)



Round Tubes

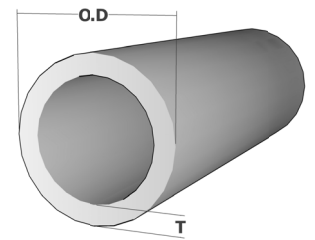

| Product Code | Ex Stock | O.D (mm) | T (mm) | Mass (kg/m) | Perimeter (mm) | Area (mm ²) |
|--------------|----------|----------|--------|-------------|----------------|-------------------------|
| RTD76T5 | * | 76.0 | 5.0 | 3.179 | 238.64 | 1115.27 |
| RTD76.2T1.3 | * | 76.2 | 1.3 | 0.872 | 239.40 | 305.90 |
| RTD80T10 | ✓ | 80.0 | 10.0 | 6.267 | 251.33 | 2199.11 |
| RTD80T12.5 | * | 80.0 | 12.5 | 7.555 | 251.33 | 2650.72 |
| RTD80T15 | * | 80.0 | 15.0 | 8.730 | 251.33 | 3063.05 |
| RTD80T22.5 | * | 80.0 | 22.5 | 11.584 | 251.33 | 4064.44 |
| RTD80.4T1.3 | * | 80.4 | 1.3 | 0.921 | 252.60 | 323.05 |
| RTD80.6T0.8 | * | 80.6 | 0.8 | 0.572 | 253.21 | 200.56 |
| RTD84.8T1.3 | * | 84.8 | 1.3 | 0.972 | 266.40 | 341.02 |
| RTD85T12.5 | * | 85.0 | 12.5 | 8.114 | 267.04 | 2847.07 |
| RTD85T15 | * | 85.0 | 15.0 | 9.401 | 267.04 | 3298.67 |
| RTD85T17.5 | * | 85.0 | 17.5 | 10.576 | 267.04 | 3711.01 |
| RTD85T25 | * | 85.0 | 25.0 | 13.430 | 267.04 | 4712.39 |
| RTD88.9T5.3 | * | 88.9 | 5.3 | 3.967 | 279.46 | 1391.98 |
| RTD89T4 | ✓ | 89.0 | 4.0 | 3.043 | 279.46 | 1067.60 |
| RTD89T5 | * | 89.0 | 5.0 | 3.760 | 279.46 | 1319.47 |
| RTD89.6T1.5 | * | 89.6 | 1.5 | 1.183 | 281.50 | 415.16 |
| RTD90T2 | * | 90.0 | 2.0 | 1.575 | 282.60 | 552.64 |
| RTD90T15 | * | 90.0 | 15.0 | 10.073 | 282.74 | 3534.29 |
| RTD90T17.5 | * | 90.0 | 17.5 | 11.360 | 282.74 | 3985.90 |
| RTD90T20 | * | 90.0 | 20.0 | 12.535 | 282.74 | 4398.23 |
| RTD90T27.5 | * | 90.0 | 27.5 | 15.389 | 282.74 | 5399.61 |
| RTD94T1.5 | * | 94.0 | 1.5 | 1.242 | 295.31 | 435.90 |
| RTD95T0.8 | * | 95.0 | 0.8 | 0.674 | 298.30 | 236.63 |
| RTD95T17.5 | * | 95.0 | 17.5 | 12.143 | 298.45 | 4260.47 |
| RTD95T20 | * | 95.0 | 20.0 | 13.430 | 298.45 | 4712.39 |
| RTD95T22.5 | * | 95.0 | 22.5 | 14.605 | 298.45 | 5124.72 |
| RTD95T30 | * | 95.0 | 30.0 | 17.459 | 298.45 | 6126.11 |
| RTD97T1 | * | 97.0 | 1.0 | 0.860 | 304.74 | 301.59 |
| RTD97T1.1 | * | 97.0 | 1.1 | 0.944 | 304.58 | 331.24 |
| RTD100T4 | ✓ | 100.0 | 4.0 | 3.436 | 314.00 | 1205.76 |
| RTD100T5 | * | 100.0 | 5.0 | 4.251 | 314.00 | 1491.50 |
| RTD100T10 | ✓ | 100.0 | 10.0 | 8.058 | 314.16 | 2827.43 |
| RTD100T20 | * | 100.0 | 20.0 | 14.326 | 314.16 | 5026.55 |
| RTD100T22.5 | * | 100.0 | 22.5 | 15.613 | 314.16 | 5478.15 |
| RTD100T25 | * | 100.0 | 25.0 | 16.788 | 314.16 | 5890.49 |
| RTD100T32.5 | * | 100.0 | 32.5 | 19.642 | 314.16 | 6891.87 |
| RTD102T0.9 | * | 102.0 | 0.9 | 0.814 | 320.28 | 285.71 |
| RTD102T1 | * | 102.0 | 1.0 | 0.904 | 320.28 | 317.14 |
| RTD102T2 | * | 102.0 | 2.0 | 1.790 | 320.28 | 628.00 |

"✓" Stocked Item
 "*" Pre-order Only Item
 (30-40 working days delivery)



Round Tubes

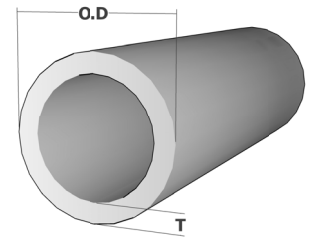

| Product Code | Ex Stock | O.D (mm) | T (mm) | Mass (kg/m) | Perimeter (mm) | Area (mm ²) |
|--------------|----------|----------|--------|-------------|----------------|-------------------------|
| RTD102T3 | * | 102.0 | 3.0 | 2.659 | 320.28 | 933.05 |
| RTD108T5 | * | 108.0 | 5.0 | 4.609 | 339.12 | 1617.10 |
| RTD110T10 | ✓ | 110.0 | 10.0 | 8.954 | 345.57 | 3141.59 |
| RTD110T15 | * | 110.0 | 15.0 | 12.759 | 345.58 | 4476.77 |
| RTD110T25 | * | 110.0 | 25.0 | 19.026 | 345.58 | 6675.88 |
| RTD110T27.5 | * | 110.0 | 27.5 | 20.313 | 345.58 | 7127.49 |
| RTD110T30 | * | 110.0 | 30.0 | 21.488 | 345.58 | 7539.82 |
| RTD110T37.5 | * | 110.0 | 37.5 | 24.342 | 345.58 | 8541.24 |
| RTD114.3T2.8 | * | 114.3 | 2.8 | 2.795 | 359.10 | 980.81 |
| RTD115.8T1.9 | * | 115.8 | 1.9 | 1.938 | 363.80 | 679.87 |
| RTD117.9T1.2 | * | 117.9 | 1.2 | 1.254 | 370.40 | 439.95 |
| RTD120T2.5 | * | 120.0 | 2.5 | 2.629 | 376.80 | 922.38 |
| RTD120T4 | ✓ | 120.0 | 4.0 | 4.152 | 376.80 | 1456.96 |
| RTD120T10 | ✓ | 120.0 | 10.0 | 9.849 | 376.80 | 3455.75 |
| RTD120T15 | * | 120.0 | 15.0 | 14.102 | 377.00 | 4948.00 |
| RTD120T20 | * | 120.0 | 20.0 | 17.907 | 377.00 | 6283.19 |
| RTD120T30 | * | 120.0 | 30.0 | 24.175 | 377.00 | 8482.30 |
| RTD120T32.5 | * | 120.0 | 32.5 | 25.462 | 377.00 | 8933.90 |
| RTD120T35 | * | 120.0 | 35.0 | 26.637 | 377.00 | 9346.23 |
| RTD120T42.5 | * | 120.0 | 42.5 | 29.491 | 377.00 | 10347.62 |
| RTD127T2 | ✓ | 127.0 | 2.0 | 2.237 | 398.78 | 785.00 |
| RTD130T10 | ✓ | 130.0 | 10.0 | 10.744 | 408.41 | 3769.91 |
| RTD130T15 | * | 130.0 | 15.0 | 15.445 | 408.41 | 5419.25 |
| RTD130T20 | * | 130.0 | 20.0 | 19.698 | 408.41 | 6911.50 |
| RTD130T25 | * | 130.0 | 25.0 | 23.503 | 408.41 | 8246.68 |
| RTD130T35 | * | 130.0 | 35.0 | 29.771 | 408.41 | 10445.80 |
| RTD130T37.5 | * | 130.0 | 37.5 | 31.058 | 408.41 | 10897.40 |
| RTD130T40 | * | 130.0 | 40.0 | 32.233 | 408.41 | 11309.73 |
| RTD130T47.5 | * | 130.0 | 47.5 | 35.087 | 408.41 | 12311.12 |
| RTD133T5 | ✓ | 133.0 | 5.0 | 5.727 | 417.62 | 2009.60 |
| RTD134T1.4 | * | 134.0 | 1.4 | 1.661 | 420.76 | 582.91 |
| RTD134T2.4 | * | 134.0 | 2.4 | 2.826 | 420.76 | 991.74 |
| RTD140T15 | * | 140.0 | 15.0 | 16.788 | 439.82 | 5890.49 |
| RTD140T20 | * | 140.0 | 20.0 | 21.488 | 439.82 | 7539.82 |
| RTD140T25 | * | 140.0 | 25.0 | 25.741 | 439.82 | 9032.10 |
| RTD140T30 | * | 140.0 | 30.0 | 29.547 | 439.82 | 10367.26 |
| RTD140T40 | * | 140.0 | 40.0 | 35.814 | 439.82 | 12566.37 |
| RTD140T42.5 | * | 140.0 | 42.5 | 37.101 | 439.82 | 13017.97 |
| RTD140T45 | * | 140.0 | 45.0 | 38.276 | 439.82 | 13430.31 |
| RTD140T52.5 | * | 140.0 | 52.5 | 41.130 | 439.82 | 14431.69 |

"✓" Stocked Item
 "*" Pre-order Only Item
 (30-40 working days delivery)



Round Tubes

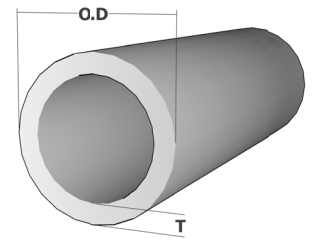

| Product Code | Ex Stock | O.D (mm) | T (mm) | Mass (kg/m) | Perimeter (mm) | Area (mm ²) |
|---------------|----------|----------|--------|-------------|----------------|-------------------------|
| RTD141T45 | * | 141.0 | 2.0 | 2.489 | 443.00 | 873.36 |
| RTD150T2 | * | 150.0 | 2.0 | 2.649 | 471.24 | 929.44 |
| RTD150T5 | ✓ | 150.0 | 5.0 | 6.488 | 471.24 | 2276.50 |
| RTD150T10 | ✓ | 150.0 | 10.0 | 12.535 | 471.24 | 4398.23 |
| RTD150T15 | * | 150.0 | 15.0 | 18.131 | 471.24 | 6361.73 |
| RTD150T20 | * | 150.0 | 20.0 | 23.279 | 471.24 | 8168.14 |
| RTD150T25 | * | 150.0 | 25.0 | 27.980 | 471.24 | 9817.48 |
| RTD150T30 | * | 150.0 | 30.0 | 32.233 | 471.24 | 11309.73 |
| RTD150T40 | * | 150.0 | 40.0 | 39.396 | 471.24 | 13823.01 |
| RTD159T6 | ✓ | 159.0 | 6.0 | 8.215 | 499.26 | 2882.52 |
| RTD160T10 | ✓ | 160.0 | 10.0 | 13.430 | 502.65 | 4712.39 |
| RTD160T15 | * | 160.0 | 15.0 | 19.474 | 502.65 | 6832.96 |
| RTD160T20 | * | 160.0 | 20.0 | 25.070 | 502.65 | 8796.46 |
| RTD160T25 | * | 160.0 | 25.0 | 30.218 | 502.65 | 10602.88 |
| RTD160T30 | * | 160.0 | 30.0 | 34.919 | 502.65 | 12252.21 |
| RTD160T35 | * | 160.0 | 35.0 | 39.172 | 502.65 | 13744.47 |
| RTD160T45 | * | 160.0 | 45.0 | 46.335 | 502.65 | 16257.74 |
| RTD162.5T38.5 | * | 162.5 | 38.5 | 42.744 | 510.51 | 14997.96 |
| RTD170T10 | * | 170.0 | 10.0 | 14.326 | 534.07 | 5026.55 |
| RTD170T15 | * | 170.0 | 15.0 | 20.817 | 534.07 | 7304.20 |
| RTD170T20 | * | 170.0 | 20.0 | 26.861 | 534.07 | 9424.78 |
| RTD170T25 | * | 170.0 | 25.0 | 32.457 | 534.07 | 11388.27 |
| RTD170T30 | * | 170.0 | 30.0 | 37.605 | 534.07 | 13194.69 |
| RTD170T35 | * | 170.0 | 35.0 | 42.305 | 534.07 | 14844.03 |
| RTD170T40 | * | 170.0 | 40.0 | 46.558 | 534.07 | 16336.28 |
| RTD170T50 | * | 170.0 | 50.0 | 53.721 | 534.07 | 18849.56 |
| RTD170.4T1.7 | * | 170.4 | 1.7 | 2.568 | 535.33 | 900.98 |
| RTD180T10 | ✓ | 180.0 | 10.0 | 15.221 | 565.49 | 5340.71 |
| RTD180T12.5 | * | 180.0 | 12.5 | 18.746 | 565.49 | 6577.71 |
| RTD180T20 | * | 180.0 | 20.0 | 28.651 | 565.49 | 10053.10 |
| RTD180T25 | * | 180.0 | 25.0 | 34.695 | 565.49 | 12173.67 |
| RTD180T30 | * | 180.0 | 30.0 | 40.291 | 565.49 | 14137.17 |
| RTD180T35 | * | 180.0 | 35.0 | 45.439 | 565.49 | 15943.58 |
| RTD180T40 | * | 180.0 | 40.0 | 50.140 | 565.49 | 17592.92 |
| RTD180T45 | * | 180.0 | 45.0 | 54.393 | 565.49 | 19085.18 |
| RTD180T55 | * | 180.0 | 55.0 | 61.556 | 565.49 | 21598.45 |
| RTD182T15 | * | 182.0 | 15.0 | 22.429 | 571.77 | 7869.69 |
| RTD185T12.5 | * | 185.0 | 12.5 | 19.306 | 581.20 | 6774.06 |
| RTD185T15 | * | 185.0 | 15.0 | 22.832 | 581.20 | 8011.06 |
| RTD185T22.5 | * | 185.0 | 22.5 | 32.736 | 581.20 | 11486.45 |

"✓" Stocked Item
 "✱" Pre-order Only Item
 (30-40 working days delivery)



Round Tubes

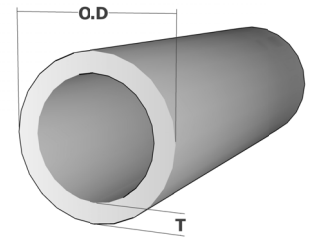

| Product Code | Ex Stock | O.D (mm) | T (mm) | Mass (kg/m) | Perimeter (mm) | Area (mm ²) |
|---------------|----------|----------|--------|-------------|----------------|-------------------------|
| RTD185T27.5 | ✱ | 185.0 | 27.5 | 38.780 | 581.20 | 13607.02 |
| RTD185T32.5 | ✱ | 185.0 | 32.5 | 44.376 | 581.20 | 15570.52 |
| RTD185T37.5 | ✱ | 185.0 | 37.5 | 49.524 | 581.20 | 17376.93 |
| RTD185T42.5 | ✱ | 185.0 | 42.5 | 54.225 | 581.20 | 19026.27 |
| RTD185T47.5 | ✱ | 185.0 | 47.5 | 58.478 | 581.20 | 20518.53 |
| RTD185T57.5 | ✱ | 185.0 | 57.5 | 65.641 | 581.20 | 23031.80 |
| RTD189.5T15.6 | ✱ | 189.5 | 15.6 | 24.290 | 595.33 | 8522.64 |
| RTD220T10 | ✓ | 220.0 | 10.0 | 18.802 | 691.15 | 6597.34 |
| RTD220T15 | ✱ | 220.0 | 15.0 | 27.532 | 691.15 | 9660.40 |
| RTD220T20 | ✱ | 220.0 | 20.0 | 35.814 | 691.15 | 12566.37 |
| RTD230T15 | ✱ | 230.0 | 15.0 | 28.875 | 722.57 | 10131.64 |
| RTD230T20 | ✱ | 230.0 | 20.0 | 37.605 | 722.57 | 13196.69 |
| RTD290T22.5 | ✱ | 290.0 | 22.5 | 53.889 | 911.06 | 18908.46 |
| RTD300T10 | ✱ | 300.0 | 10.0 | 25.965 | 942.48 | 9110.62 |
| RTD318T5.2 | ✱ | 318.0 | 5.2 | 15.648 | 999.03 | 5490.61 |
| RTD320T10 | ✱ | 320.0 | 10.0 | 27.756 | 1005.31 | 9738.94 |

"✓" Stocked Item
 "✱" Pre-order Only Item
 (30-40 working days delivery)



Equal Angles

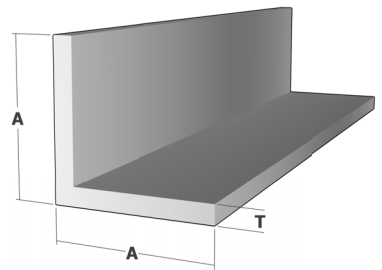

| Product Code | Ex Stock | A (mm) | T (mm) | Mass (kg/m) | Perimeter (mm) | Area (mm ²) |
|--------------|----------|--------|--------|-------------|----------------|-------------------------|
| EAA9T0.6 | * | 9.0 | 0.6 | 0.030 | 36.00 | 10.40 |
| EAA10T1.6 | * | 10.0 | 1.6 | 0.084 | 40.00 | 29.44 |
| EAA11T1.2 | * | 11.0 | 1.2 | 0.073 | 44.00 | 25.64 |
| EAA12T1.2 | * | 12.0 | 1.2 | 0.078 | 48.00 | 27.36 |
| EAA12T1.6 | ✓ | 12.0 | 1.6 | 0.102 | 47.00 | 35.70 |
| EAA12T3 | ✓ | 12.0 | 3.0 | 0.179 | 47.00 | 62.92 |
| EAA12.5T0.6 | * | 12.5 | 0.6 | 0.042 | 50.00 | 14.60 |
| EASA15T1.2 | ✓ | 15.0 | 1.2 | 0.097 | 60.00 | 34.12 |
| EAA16 T1.5 | ✓ | 16.0 | 1.5 | 0.130 | 63.00 | 45.60 |
| EAA19T0.65 | * | 19.0 | 0.65 | 0.069 | 76.00 | 24.20 |
| EASA19T1.5 | ✓ | 19.0 | 1.5 | 0.155 | 76.00 | 54.30 |
| EAA19T1.9 | ✓ | 19.0 | 1.9 | 0.195 | 76.00 | 68.50 |
| EAA20T0.8 | * | 20.0 | 0.8 | 0.089 | 80.00 | 31.22 |
| EAA20T1.5 | * | 20.0 | 1.5 | 0.163 | 80.00 | 57.27 |
| EAA20T1.6 | ✓ | 20.0 | 1.6 | 0.175 | 80.00 | 61.44 |
| EASA20T3 | ✓ | 20.0 | 3.0 | 0.322 | 77.00 | 113.14 |
| EAA22T1.1 | ✓ | 22.0 | 1.1 | 0.135 | 88.00 | 47.20 |
| EASA25T1.4 | * | 25.0 | 1.4 | 0.194 | 100.00 | 68.04 |
| EASA25T1.5 | ✓ | 25.0 | 1.5 | 0.206 | 100.00 | 72.30 |
| EAA25T2.5 | ✓ | 25.0 | 2.5 | 0.217 | 79.50 | 76.00 |
| EAA25T3 | ✓ | 25.0 | 3.0 | 0.400 | 99.00 | 140.52 |
| EAA25.4T1.9 | * | 25.4 | 1.9 | 0.153 | 70.00 | 53.76 |
| EASA29.5T3 | * | 29.5 | 3.0 | 0.473 | 118.00 | 166.00 |
| EAA30T1 | * | 30.0 | 1.0 | 0.168 | 120.00 | 58.90 |
| EAA30T1.5 | ✓ | 30.0 | 1.5 | 0.250 | 119.23 | 87.67 |
| EAA30T2.0 | * | 30.0 | 2.0 | 0.331 | 120.00 | 116.00 |
| EAA30T2.5 | * | 30.0 | 2.5 | 0.409 | 120.00 | 143.35 |
| EAA30T3 | ✓ | 30.0 | 3.0 | 0.487 | 120.00 | 171.00 |
| GM-LZY-42 | ✓ | 30.0 | 3.0 | 0.487 | 120.00 | 171.00 |
| EASA30T3 | ✓ | 30.0 | 3.0 | 0.487 | 120.00 | 171.00 |
| EAA30T4 | ✓ | 30.0 | 4.0 | 0.638 | 120.00 | 223.70 |
| EAA30T4.5 | * | 30.0 | 4.5 | 0.712 | 119.00 | 249.67 |
| EAA30T5.5 | * | 30.0 | 5.5 | 0.854 | 119.00 | 299.67 |
| EAA35T1.5 | ✓ | 35.0 | 1.5 | 0.293 | 140.00 | 102.75 |
| EAA37.8T1.8 | * | 37.8 | 1.8 | 0.378 | 151.00 | 132.80 |
| EASA38T1.5 | ✓ | 38.0 | 1.5 | 0.317 | 152.00 | 111.30 |
| EAA38T3 | * | 38.0 | 3.0 | 0.624 | 152.00 | 218.92 |
| EAA40T1.6 | ✓ | 40.0 | 1.6 | 0.357 | 159.00 | 125.36 |
| EAA40T2 | * | 40.0 | 2.0 | 0.445 | 160.00 | 156.00 |
| EAA40T3 | ✓ | 40.0 | 3.0 | 0.658 | 160.00 | 231.00 |

"✓" Stocked Item
 "✱" Pre-order Only Item
 (30-40 working days delivery)



Equal Angles

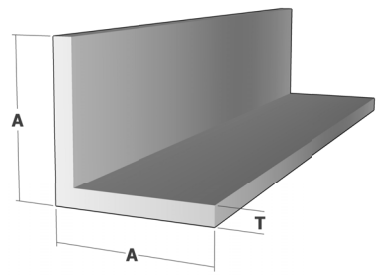

| Product Code | Ex Stock | A (mm) | T (mm) | Mass (kg/m) | Perimeter (mm) | Area (mm ²) |
|--------------|----------|--------|--------|-------------|----------------|-------------------------|
| EAA40T4 | * | 40.0 | 4.0 | 0.866 | 160.00 | 304.00 |
| EAA40T6 | ✓ | 40.0 | 6.0 | 1.270 | 160.00 | 444.00 |
| EASA40T7 | * | 40.0 | 7.0 | 1.448 | 159.00 | 508.23 |
| EAA50T1.6 | ✓ | 50.0 | 1.6 | 0.449 | 200.00 | 157.44 |
| EAA50T2 | ✓ | 50.0 | 2.0 | 0.559 | 200.00 | 196.00 |
| EAA50T3 | ✓ | 50.0 | 3.0 | 0.829 | 200.00 | 291.00 |
| EAA50T4 | ✓ | 50.0 | 4.0 | 1.094 | 200.00 | 384.00 |
| EAA50T4.7 | * | 50.0 | 4.7 | 1.276 | 200.00 | 447.80 |
| EAA50T6 | ✓ | 50.0 | 6.0 | 1.607 | 199.00 | 563.92 |
| EASA55T5 | * | 55.0 | 5.0 | 1.511 | 217.00 | 530.27 |
| EASA60T1.5 | ✓ | 60.0 | 1.5 | 0.507 | 240.00 | 177.75 |
| EASA60T2 | ✓ | 60.0 | 2.0 | 0.673 | 240.00 | 236.00 |
| EASA60T5 | * | 60.0 | 5.0 | 1.592 | 240.00 | 558.54 |
| EAA60T6 | ✓ | 60.0 | 6.0 | 1.949 | 240.00 | 684.00 |
| EAA64T15 | * | 64.0 | 15.0 | 4.844 | 253.00 | 1699.80 |
| EAA65T6 | ✓ | 65.0 | 6.0 | 2.120 | 260.00 | 744.00 |
| EAA75T3 | ✓ | 75.0 | 3.0 | 1.257 | 300.00 | 441.00 |
| EAA75T6 | ✓ | 75.0 | 6.0 | 2.462 | 300.00 | 864.00 |
| EAA75T12 | * | 75.0 | 12.0 | 4.720 | 300.00 | 1656.00 |
| EAA100T3 | ✓ | 80.0 | 6.0 | 2.633 | 320.00 | 924.00 |
| EAA100T6 | ✓ | 90.0 | 6.0 | 2.975 | 360.00 | 1044.00 |
| EAA100T3 | ✓ | 100.0 | 3.0 | 1.684 | 400.00 | 591.00 |
| EAA100T6 | ✓ | 100.0 | 6.0 | 3.317 | 399.00 | 1163.80 |
| EAA120T10 | ✓ | 120.0 | 10.0 | 6.555 | 480.00 | 2300.00 |
| EAA150T10 | ✓ | 150.0 | 10.0 | 8.265 | 599.00 | 2899.92 |
| EAA200T20 | * | 200.0 | 20.0 | 21.660 | 800.00 | 7600.00 |

"✓" Stocked Item

"*" Pre-order Only Item
(30-40 working days delivery)



Unequal Angles

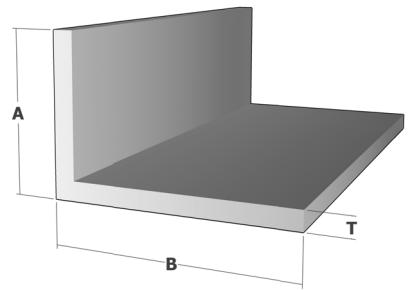

| Product Code | Ex Stock | A (mm) | B (mm) | T (mm) | Mass (kg/m) | Perimeter (mm) | Area (mm ²) |
|-------------------|----------|--------|--------|--------|-------------|----------------|-------------------------|
| UAA10B5T1 | * | 10.0 | 5.0 | 1.0 | 0.040 | 29.23 | 13.92 |
| UAA15B10T1 | * | 15.0 | 10.0 | 1.0 | 0.068 | 50.00 | 24.00 |
| UAA18B10T1 | ✓ | 18.0 | 10.0 | 1.0 | 0.077 | 56.00 | 27.00 |
| UAA19B8T1.5 | * | 19.0 | 8.0 | 1.5 | 0.105 | 52.98 | 36.82 |
| UAA20B11T1.5 | * | 20.0 | 11.0 | 1.5 | 0.126 | 62.00 | 44.25 |
| UAA20B11.5T2 | * | 20.0 | 11.5 | 2.0 | 0.167 | 91.93 | 58.73 |
| UAA20B12T1.6 | ✓ | 20.0 | 12.0 | 1.6 | 0.138 | 62.70 | 48.50 |
| UAA20B12T3 | ✓ | 20.0 | 12.0 | 3.0 | 0.248 | 63.23 | 86.92 |
| UAA20B14T2 | * | 20.0 | 14.0 | 2.0 | 0.182 | 68.00 | 64.00 |
| UAA20.3B7.1T1.1 | * | 20.3 | 7.1 | 1.1 | 0.082 | 54.16 | 28.83 |
| UAA21B20T2 | * | 21.0 | 20.0 | 2.0 | 0.220 | 81.14 | 77.20 |
| UAA21.2B13.7T1.2 | * | 21.2 | 13.7 | 1.2 | 0.115 | 69.40 | 40.30 |
| UAA21.6B7.8T1.6 | * | 21.6 | 7.8 | 1.6 | 0.125 | 57.17 | 43.93 |
| UAA24B16T1.5 | * | 24.0 | 16.0 | 1.5 | 0.165 | 80.00 | 57.75 |
| UAA25B12T1.6 | ✓ | 25.0 | 12.0 | 1.6 | 0.161 | 74.00 | 56.64 |
| UAA25B12.4T2 | * | 25.0 | 12.4 | 2.0 | 0.201 | 73.50 | 70.60 |
| UAA25B20T1.6 | ✓ | 25.0 | 20.0 | 1.6 | 0.198 | 88.70 | 69.30 |
| UAA25B20T2 | * | 25.0 | 20.0 | 2.0 | 0.245 | 90.00 | 86.00 |
| UAA25B20T3 | ✓ | 25.0 | 20.0 | 3.0 | 0.359 | 90.00 | 126.00 |
| UASA29.2B17.3T2.8 | * | 29.2 | 17.3 | 2.8 | 0.307 | 92.20 | 107.80 |
| UASA30B8.5T1.5 | * | 30.0 | 8.5 | 1.5 | 0.148 | 77.00 | 51.95 |
| UAA30B17T2 | * | 30.0 | 17.0 | 2.0 | 0.257 | 94.00 | 90.00 |
| UAA30B20T1.7 | * | 30.0 | 20.0 | 1.7 | 0.274 | 100.00 | 96.67 |
| UAA30B20T2.5 | ✓ | 30.0 | 20.0 | 2.5 | 0.338 | 99.00 | 118.67 |
| UAA30B25T2 | ✓ | 30.0 | 25.0 | 2.0 | 0.302 | 110.00 | 106.00 |
| UAA30B25T4 | * | 30.0 | 25.0 | 4.0 | 0.581 | 109.23 | 203.92 |
| UAA30B26T6 | * | 30.0 | 26.0 | 6.0 | 0.857 | 112.00 | 300.80 |
| UASA33.5B25T3 | ✓ | 33.5 | 25.0 | 3.0 | 0.472 | 117.00 | 165.60 |
| UAA38B11T1 | * | 38.0 | 11.0 | 1.0 | 0.137 | 98.00 | 48.00 |
| UAA38.5B26.5T4 | * | 38.5 | 26.5 | 4.0 | 0.695 | 130.00 | 244.00 |
| UAA38.5B26.5T8 | * | 38.5 | 26.5 | 8.0 | 1.300 | 130.00 | 456.00 |
| UASA40B12T3 | ✓ | 40.0 | 12.0 | 3.0 | 0.419 | 104.00 | 147.00 |
| UASA40B17T2 | * | 40.0 | 17.0 | 2.0 | 0.314 | 114.00 | 110.00 |
| UASA40B20T2 | ✓ | 40.0 | 20.0 | 2.0 | 0.331 | 120.00 | 116.00 |
| UASA40B25T1.5 | ✓ | 40.0 | 25.0 | 1.5 | 0.271 | 130.00 | 95.25 |
| UASA40B25T3 | ✓ | 40.0 | 25.0 | 3.0 | 0.530 | 130.00 | 186.00 |
| UAA40B25T2 | * | 40.0 | 25.0 | 2.0 | 0.358 | 130.00 | 125.60 |
| UASA41B26T6 | * | 41.0 | 26.0 | 6.0 | 1.045 | 134.00 | 366.80 |
| UASA42B22T2 | * | 42.0 | 22.0 | 2.0 | 0.351 | 125.85 | 123.00 |
| UAA44B30T3 | ✓ | 44.0 | 30.0 | 3.0 | 0.627 | 148.00 | 219.90 |

"✓" Stocked Item
 "✱" Pre-order Only Item
 (30-40 working days delivery)



Unequal Angles

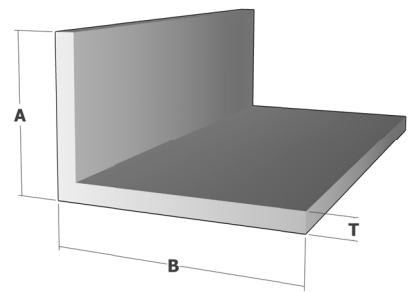

| Product Code | Ex Stock | A (mm) | B (mm) | T (mm) | Mass (kg/m) | Perimeter (mm) | Area (mm ²) |
|---------------|----------|--------|--------|--------|-------------|----------------|-------------------------|
| UAA45B8T1.2 | ✱ | 45.0 | 8.0 | 1.2 | 0.177 | 106.00 | 62.10 |
| UAA45B10T1 | ✱ | 45.0 | 10.0 | 1.0 | 0.154 | 110.00 | 54.00 |
| UAA45B35T3 | ✱ | 45.0 | 35.0 | 3.0 | 0.658 | 160.00 | 231.00 |
| UAA50B20T1.6 | ✓ | 50.0 | 20.0 | 1.6 | 0.312 | 140.00 | 109.44 |
| UAA50B20T3 | ✓ | 50.0 | 20.0 | 3.0 | 0.573 | 140.00 | 201.00 |
| UAA50B25T1.5 | ✓ | 50.0 | 25.0 | 1.5 | 0.314 | 148.70 | 110.00 |
| UAA50B25T3 | ✓ | 50.0 | 25.0 | 3.0 | 0.615 | 148.70 | 215.80 |
| UAA50B30T1.5 | ✓ | 50.0 | 30.0 | 1.5 | 0.355 | 159.23 | 117.67 |
| UAA50B30T4 | ✓ | 50.0 | 30.0 | 4.0 | 0.866 | 160.00 | 304.00 |
| UAA50B28T4 | ✱ | 50.0 | 28.0 | 4.0 | 0.844 | 156.00 | 296.00 |
| UAA50B40T3 | ✱ | 50.0 | 40.0 | 3.0 | 0.744 | 180.00 | 261.00 |
| UAA52B20T2 | ✱ | 52.0 | 20.0 | 2.0 | 0.399 | 144.00 | 140.00 |
| UAA52B30T2 | ✱ | 52.0 | 30.0 | 2.0 | 0.456 | 164.00 | 160.00 |
| UAA52B40T22 | ✱ | 52.0 | 40.0 | 22.0 | 4.389 | 184.00 | 1540.00 |
| UAA55B40T4 | ✓ | 55.0 | 40.0 | 4.0 | 1.037 | 190.00 | 363.93 |
| UAA60B25T3 | ✓ | 60.0 | 25.0 | 3.0 | 0.701 | 168.70 | 245.80 |
| UAA60B25T4 | ✱ | 60.0 | 25.0 | 4.0 | 0.923 | 169.23 | 323.93 |
| UAA60B30T2 | ✓ | 60.0 | 30.0 | 2.0 | 0.502 | 180.00 | 176.00 |
| UASA60B40T10 | ✱ | 60.0 | 40.0 | 10.0 | 2.567 | 196.57 | 900.86 |
| UAA60B50T4.7 | ✱ | 60.0 | 50.0 | 4.7 | 1.410 | 220.00 | 494.80 |
| UAA62B32T3 | ✱ | 62.0 | 32.0 | 2.0 | 0.524 | 188.00 | 184.00 |
| UAA63B25T3 | ✱ | 63.0 | 25.0 | 3.0 | 0.726 | 176.33 | 254.84 |
| UAA64B25T10 | ✱ | 64.0 | 25.0 | 10.0 | 2.394 | 172.96 | 840.00 |
| UAA64B25T10 | ✱ | 64.0 | 25.0 | 10.0 | 2.394 | 172.96 | 840.00 |
| UAA64B25T10 | ✱ | 64.0 | 25.0 | 10.0 | 2.468 | 172.68 | 865.88 |
| UAA65B25T10 | ✱ | 65.0 | 25.0 | 10.0 | 2.417 | 174.71 | 847.99 |
| UAA70B25T1.5 | ✓ | 70.0 | 25.0 | 1.5 | 0.400 | 190.00 | 140.25 |
| UAA70B35T3 | ✱ | 70.0 | 35.0 | 3.0 | 0.881 | 205.92 | 309.17 |
| UAA70B40T5 | ✓ | 70.0 | 40.0 | 5.0 | 1.494 | 220.00 | 524.10 |
| UAA70B50T4.7 | ✓ | 70.0 | 50.0 | 4.7 | 1.544 | 240.00 | 541.80 |
| UAA75B25T1.5 | ✓ | 75.0 | 25.0 | 1.5 | 0.421 | 200.00 | 147.75 |
| UAA75B25T3 | ✓ | 75.0 | 25.0 | 3.0 | 0.829 | 198.70 | 290.80 |
| UAA75B50T3 | ✓ | 75.0 | 50.0 | 3.0 | 1.043 | 250.00 | 366.00 |
| UAA75B50T6 | ✓ | 75.0 | 50.0 | 6.0 | 2.035 | 250.00 | 714.00 |
| UASA80B40T10 | ✱ | 80.0 | 40.0 | 10.0 | 3.137 | 236.57 | 1100.86 |
| UASA80B50T2 | ✱ | 80.0 | 50.0 | 2.0 | 0.730 | 257.94 | 255.97 |
| UAA80B50T4.7 | ✱ | 80.0 | 50.0 | 4.7 | 1.678 | 260.00 | 588.80 |
| UAA90B80T10.4 | ✱ | 90.0 | 80.0 | 10.4 | 4.730 | 339.23 | 1659.80 |
| UAA100B25T3 | ✓ | 100.0 | 25.0 | 3.0 | 1.043 | 248.70 | 365.80 |
| UAA100B50T4 | ✓ | 100.0 | 50.0 | 4.0 | 1.664 | 300.00 | 584.00 |

"✓" Stocked Item
 "✱" Pre-order Only Item
 (30-40 working days delivery)



Unequal Angles

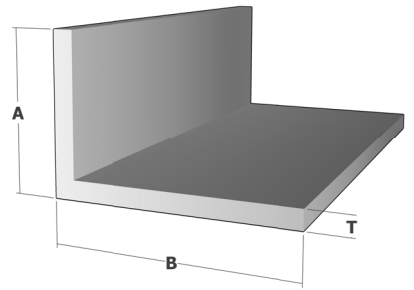

| Product Code | Ex Stock | A (mm) | B (mm) | T (mm) | Mass (kg/m) | Perimeter (mm) | Area (mm ²) |
|------------------|----------|--------|--------|--------|-------------|----------------|-------------------------|
| UAA100B50T5 | ✱ | 100.0 | 50.0 | 5.0 | 2.066 | 299.30 | 725.00 |
| UAA100B50T6 | ✓ | 100.0 | 50.0 | 6.0 | 2.462 | 299.23 | 863.92 |
| UAA100B50T8 | ✱ | 100.0 | 50.0 | 8.0 | 3.237 | 300.00 | 1135.92 |
| UAA100B65T6 | ✱ | 100.0 | 65.0 | 6.0 | 2.718 | 328.70 | 953.80 |
| UAA100B75T8 | ✓ | 100.0 | 75.0 | 8.0 | 3.808 | 350.00 | 1336.00 |
| UAA110B25T10 | ✱ | 110.0 | 25.0 | 10.0 | 3.563 | 270.00 | 1250.00 |
| UASA110B70T12 | ✱ | 110.0 | 70.0 | 12.0 | 4.628 | 360.00 | 1624.00 |
| UAA125B40T6 | ✓ | 125.0 | 50.0 | 8.0 | 3.808 | 350.00 | 1336.00 |
| UAA130B30T1.8 | ✱ | 130.0 | 30.0 | 1.8 | 0.811 | 319.23 | 284.68 |
| UAA130B50T2 | ✱ | 130.0 | 50.0 | 2.0 | 1.014 | 359.23 | 355.92 |
| UAA150B50T2.5 | ✓ | 150.0 | 50.0 | 2.5 | 1.407 | 400.00 | 493.75 |
| UAA150B75T6 | ✓ | 150.0 | 75.0 | 6.0 | 3.745 | 450.00 | 1314.00 |
| UAA150B75T10 | ✱ | 150.0 | 75.0 | 10.0 | 6.127 | 449.23 | 2149.92 |
| UAA150B100T8 | ✓ | 150.0 | 100.0 | 8.0 | 5.518 | 500.00 | 1936.00 |
| UAA150B120T10 | ✓ | 150.0 | 120.0 | 10.0 | 7.410 | 540.00 | 2600.00 |
| UAA200B75T10 | ✓ | 200.0 | 75.0 | 8.0 | 6.088 | 550.00 | 2136.00 |
| UAA200B100T10 | ✓ | 200.0 | 100.0 | 10.0 | 8.265 | 599.23 | 2899.92 |
| UAA203B50.8T10.2 | ✓ | 203.0 | 50.8 | 10.2 | 7.178 | 499.62 | 2518.66 |

"✓" Stocked Item
 "✱" Pre-order Only Item
 (30-40 working days delivery)



U Channels

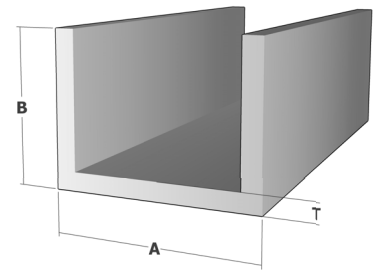

| Product Code | Ex Stock | A (mm) | B (mm) | T (mm) | Mass (kg/m) | Perimeter (mm) | Area (mm ²) |
|------------------|----------|--------|--------|--------|-------------|----------------|-------------------------|
| CLA4.3B8T0.6 | ✓ | 4.3 | 8.0 | 0.6 | 0.032 | 38.37 | 11.38 |
| CLSA5.4B22T1.5 | ✱ | 5.4 | 11.0 | 1.5 | 0.103 | 50.20 | 36.13 |
| CLA7.2B9.9T1.3 | ✱ | 7.2 | 9.9 | 1.3 | 0.087 | 51.72 | 30.40 |
| CLA8B9.3T0.65 | ✓ | 8.0 | 9.3 | 0.65 | 0.047 | 50.83 | 16.35 |
| CLA8.7B9T0.6 | ✱ | 8.7 | 9.0 | 0.6 | 0.043 | 51.20 | 15.22 |
| CLSA8.84B5T2 | ✱ | 8.84 | 5.0 | 2.0 | 0.070 | 32.48 | 24.53 |
| CLA10B10T1.5 | ✓ | 10.0 | 10.0 | 1.5 | 0.115 | 56.00 | 40.42 |
| CLA10B15T1.4 | ✱ | 10.0 | 15.0 | 1.4 | 0.148 | 77.2 | 52.08 |
| CLA10.3B15T1.5 | ✱ | 10.3 | 15.0 | 1.5 | 0.159 | 77.6 | 55.95 |
| CLA12B12T1.5 | ✓ | 12.0 | 12.0 | 1.5 | 0.141 | 68.00 | 49.42 |
| CLA12B4T2 | ✱ | 12.0 | 4.0 | 2.0 | 0.091 | 36.00 | 32.00 |
| CLA12B12T0.5 | ✱ | 12.0 | 12.0 | 0.5 | 0.045 | 70.20 | 15.75 |
| CLA13B20T1.25 | ✱ | 13.0 | 20.0 | 1.25 | 0.180 | 103.50 | 63.13 |
| CLA15.6B20T1.5 | ✱ | 15.6 | 20.0 | 1.5 | 0.225 | 108.20 | 78.90 |
| CLA16B16T1.6 | ✓ | 16.0 | 16.0 | 1.6 | 0.204 | 91.10 | 71.50 |
| CLA16B30T1.5 | ✱ | 16.0 | 30.0 | 1.5 | 0.312 | 149.00 | 109.50 |
| CLA16B60T4.0 | ✱ | 16.0 | 60.0 | 4.0 | 1.479 | 253.88 | 518.87 |
| CLA18B12T0.5 | ✱ | 18.0 | 12.0 | 0.5 | 0.053 | 82.20 | 18.45 |
| CLSA19B3T1 | ✱ | 19.0 | 3.0 | 1.0 | 0.063 | 46.25 | 22.27 |
| CLA19B13T0.5 | ✱ | 19.0 | 13.0 | 0.5 | 0.063 | 89.00 | 22.00 |
| CLA19.6B19.6T1.3 | ✓ | 19.6 | 19.6 | 1.3 | 0.207 | 113.40 | 72.70 |
| CLA20B10T1.5 | ✱ | 20.0 | 10.0 | 1.5 | 0.158 | 77.00 | 55.50 |
| CLA20B20T3 | ✓ | 20.0 | 20.0 | 3.0 | 0.461 | 112.30 | 161.80 |
| CLSA20B25T2.6 | ✓ | 20.0 | 25.0 | 2.6 | 0.497 | 133.00 | 174.30 |
| CLSA21B21T1.5 | ✱ | 21.0 | 21.0 | 1.5 | 0.257 | 123.00 | 90.00 |
| CLSA22B22T3 | ✓ | 22.0 | 22.0 | 3.0 | 0.513 | 434.13 | 179.92 |
| CLSA22B60T3 | ✱ | 22.0 | 60.0 | 3.0 | 1.251 | 271.20 | 438.80 |
| CLSA22.5B35T3.5 | ✓ | 22.5 | 35.0 | 3.5 | 0.860 | 174.00 | 301.80 |
| CLA23B20T2 | ✱ | 23.0 | 20.0 | 2.0 | 0.107 | 40.84 | 37.70 |
| CLA23B15T1 | ✓ | 23.0 | 15.0 | 1.0 | 0.145 | 102.80 | 51.00 |
| CLA24B7.5T2.4 | ✱ | 24.0 | 7.5 | 2.4 | 0.234 | 72.20 | 82.00 |
| CLSA24B12T1 | ✱ | 24.0 | 12.0 | 1.0 | 0.130 | 92.73 | 45.72 |
| CLA25B20T1 | ✱ | 25.0 | 20.0 | 1.0 | 0.179 | 127.00 | 62.92 |
| CLA25B25T3 | ✓ | 25.0 | 25.0 | 3.0 | 0.590 | 143.00 | 207.00 |
| CLA25B25T1.9 | ✓ | 25.0 | 25.0 | 1.9 | 0.385 | 147.00 | 135.20 |
| CLA25B50T2 | ✓ | 25.0 | 50.0 | 2.0 | 0.690 | 246.00 | 242.00 |
| CLA25B50T3 | ✓ | 25.0 | 50.0 | 3.0 | 1.017 | 243.00 | 357.00 |
| CLA25.5B12.8T1 | ✱ | 25.5 | 12.8 | 1.0 | 0.140 | 99.17 | 49.02 |
| CLSA26B15.5T0.7 | ✱ | 26.0 | 15.5 | 0.7 | 0.112 | 111.40 | 39.34 |
| CLSA28.8B35T3.5 | ✓ | 28.8 | 35.0 | 3.5 | 0.932 | 187.00 | 327.00 |

"✓" Stocked Item
 "✱" Pre-order Only Item
 (30-40 working days delivery)



U Channels

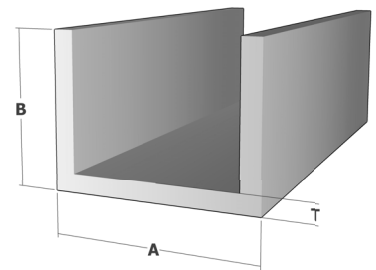

| Product Code | Ex Stock | A (mm) | B (mm) | T (mm) | Mass (kg/m) | Perimeter (mm) | Area (mm ²) |
|------------------|----------|--------|--------|--------|-------------|----------------|-------------------------|
| CLA30B10T2 | ✱ | 30.0 | 10.0 | 2.0 | 0.262 | 96.00 | 92.00 |
| CLA30B17T1.2 | ✱ | 30.0 | 17.0 | 1.2 | 0.239 | 124.60 | 84.00 |
| CLA30B20T1 | ✱ | 30.0 | 20.0 | 1.0 | 0.194 | 137.00 | 67.92 |
| CLA35B7.5T2.4 | ✱ | 35.0 | 7.5 | 2.4 | 0.309 | 94.20 | 108.40 |
| CLSA35B9.5T3.3 | ✱ | 35.0 | 9.5 | 3.3 | 0.512 | 100.00 | 179.70 |
| CLA35B13T2 | ✱ | 35.0 | 13.0 | 2.0 | 0.325 | 118.00 | 114.00 |
| CLSA35B15T4 | ✱ | 35.0 | 15.0 | 4.0 | 0.726 | 117.43 | 254.79 |
| CLA35.5B17T3 | ✱ | 35.5 | 17.0 | 3.0 | 0.543 | 131.87 | 190.42 |
| CLA36B36T2.5 | ✓ | 36.0 | 36.0 | 2.5 | 0.733 | 209.30 | 257.30 |
| CLSA36.2B11.9T2 | ✱ | 36.2 | 11.9 | 2.0 | 0.319 | 115.20 | 111.92 |
| CLA38.2B12.8T1 | ✱ | 38.2 | 12.8 | 1.0 | 0.177 | 124.20 | 62.00 |
| CLA40B11.5T2 | ✱ | 40.0 | 11.5 | 2.0 | 0.335 | 120.71 | 117.68 |
| CLA40B15T3 | ✓ | 40.0 | 15.0 | 3.0 | 0.547 | 132.28 | 191.79 |
| CLSA40B19T4 | ✱ | 40.0 | 19.0 | 4.0 | 0.787 | 144.14 | 276.03 |
| CLA40B20T1.6 | ✱ | 40.0 | 20.0 | 1.6 | 0.350 | 155.77 | 122.80 |
| CLA40B25T3 | ✓ | 40.0 | 25.0 | 3.0 | 0.718 | 172.30 | 251.80 |
| CLSA41B45T3 | ✱ | 41.0 | 45.0 | 3.0 | 1.035 | 252.65 | 363.00 |
| CLA44B50T4 | ✓ | 44.0 | 50.0 | 4.0 | 1.550 | 278.30 | 543.80 |
| CLA44B50T6 | ✱ | 44.0 | 50.0 | 6.0 | 2.230 | 270.94 | 782.57 |
| CLA45B8T1.2 | ✱ | 45.0 | 8.0 | 1.2 | 0.200 | 118.60 | 70.20 |
| CLA45.5B27T5 | ✱ | 45.5 | 27.0 | 5.0 | 1.275 | 188.00 | 447.42 |
| CLA46B20T2 | ✱ | 46.0 | 20.0 | 2.0 | 0.467 | 168.00 | 164.00 |
| CLA46B27T5 | ✱ | 46.0 | 27.0 | 5.0 | 1.282 | 189.00 | 449.92 |
| CLA46.5B27T4.5 | ✱ | 46.5 | 27.0 | 4.5 | 1.173 | 191.00 | 411.67 |
| CLSA46.6B22.5T3 | ✱ | 46.6 | 22.5 | 3.0 | 0.729 | 177.00 | 255.71 |
| CLA48B19T1 | ✱ | 48.0 | 18.8 | 1.0 | 0.247 | 168.28 | 86.79 |
| CLA48B75T8 | ✱ | 48.0 | 75.0 | 8.0 | 4.150 | 380.00 | 1456.00 |
| CLA48.5B18.8T1 | ✱ | 48.5 | 18.8 | 1.0 | 0.239 | 168.92 | 83.89 |
| CLA48.5B24.5T1.7 | ✱ | 48.5 | 24.5 | 1.7 | 0.400 | 188.94 | 140.20 |
| CLA49.5B38T3 | ✱ | 49.5 | 38.0 | 3.0 | 1.021 | 243.97 | 358.42 |
| CLSA50B9T3 | ✱ | 50.0 | 9.0 | 3.0 | 0.529 | 128.37 | 185.53 |
| CLA50B10T3 | ✱ | 50.0 | 10.0 | 3.0 | 0.547 | 133.00 | 191.90 |
| CLA50B15T3 | ✓ | 50.0 | 15.0 | 3.0 | 0.633 | 154.00 | 222.00 |
| GM-NZJUN-012 | ✓ | 50.0 | 25.0 | 3.0 | 0.793 | 191.50 | 278.30 |
| CLSA50B25T3 | ✓ | 50.0 | 25.0 | 3.0 | 0.803 | 193.00 | 281.90 |
| CLA50B30T4 | ✱ | 50.0 | 30.0 | 4.0 | 1.163 | 212.00 | 408.00 |
| CLSA50B36T6 | ✱ | 50.0 | 36.0 | 6.0 | 1.730 | 228.57 | 606.87 |
| CLSA50B50T3 | ✱ | 50.0 | 50.0 | 3.0 | 1.219 | 292.40 | 427.80 |
| CLA50B50T3 | ✓ | 50.0 | 50.0 | 3.0 | 1.231 | 292.96 | 431.92 |
| CLA50.6B20T1 | ✱ | 50.6 | 20.0 | 1.0 | 0.252 | 177.92 | 88.39 |

"✓" Stocked Item
 "✱" Pre-order Only Item
 (30-40 working days delivery)



U Channels

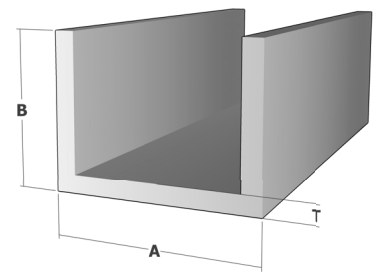

| Product Code | Ex Stock | A (mm) | B (mm) | T (mm) | Mass (kg/m) | Perimeter (mm) | Area (mm ²) |
|-------------------|----------|--------|--------|--------|-------------|----------------|-------------------------|
| CLA51B13T1 | * | 51.0 | 13.0 | 1.0 | 0.213 | 151.00 | 74.80 |
| CLA51.1B20T1 | * | 51.1 | 20.0 | 1.0 | 0.253 | 178.95 | 88.91 |
| CLA51.4B110T4 | * | 51.4 | 110.0 | 4.0 | 3.004 | 534.00 | 1054.00 |
| CLSA51.8B25T0.9 | * | 51.8 | 25.0 | 0.9 | 0.258 | 201.20 | 90.50 |
| CLSA55B30T3 | * | 55.0 | 30.0 | 3.0 | 0.929 | 221.40 | 326.00 |
| CLA56B27T4.5 | * | 56.0 | 27.0 | 4.5 | 1.295 | 210.00 | 454.42 |
| CLA56B27T5 | * | 56.0 | 27.0 | 5.0 | 1.425 | 209.00 | 499.92 |
| CLA57B15T3 | ✓ | 57.0 | 15.0 | 3.0 | 0.693 | 168.00 | 243.00 |
| CLA58B20T2 | * | 58.0 | 20.0 | 2.0 | 0.536 | 192.00 | 188.00 |
| CLA58B65T3.5 | ✓ | 58.0 | 65.0 | 3.5 | 1.873 | 367.42 | 657.10 |
| CLSA69B59T4 | * | 59.0 | 69.0 | 4.0 | 2.128 | 383.90 | 746.70 |
| CLA60B40T3.5 | * | 60.0 | 40.0 | 3.5 | 1.351 | 263.56 | 473.87 |
| CLA60B70T4 | * | 60.0 | 70.0 | 4.0 | 2.189 | 392.00 | 768.00 |
| CLA60B110T4 | * | 60.0 | 110.0 | 4.0 | 3.101 | 559.00 | 1088.00 |
| CLSA61B150T5 | * | 61.0 | 150.0 | 5.0 | 4.480 | 705.50 | 1571.98 |
| CLA65B25T4 | ✓ | 65.0 | 25.0 | 4.0 | 1.220 | 222.00 | 428.00 |
| CLA65B40T10 | * | 65.0 | 40.0 | 10.0 | 3.809 | 259.13 | 1336.57 |
| CLA68B19T1 | * | 68.0 | 19.0 | 1.0 | 0.296 | 209.00 | 103.92 |
| CLA70B12T1 | * | 70.0 | 12.0 | 1.0 | 0.308 | 217.00 | 107.92 |
| CLA70B20T1 | * | 70.0 | 20.0 | 1.0 | 0.308 | 217.00 | 107.92 |
| CLA75B25T3 | ✓ | 75.0 | 25.0 | 3.0 | 1.017 | 242.30 | 356.80 |
| CLA75B40T3 | ✓ | 75.0 | 40.0 | 3.0 | 1.273 | 302.30 | 446.80 |
| CLA76.5B12.8T1.1 | * | 76.5 | 12.8 | 1.1 | 0.312 | 200.50 | 109.6 |
| CLA80B36T5 | * | 80.0 | 36.0 | 5.0 | 2.028 | 291.51 | 711.60 |
| CLSA80B39.8T3.9 | * | 80.0 | 39.8 | 3.9 | 1.701 | 305.39 | 596.96 |
| CLA80B30T2 | * | 80.0 | 30.0 | 2.0 | 0.778 | 276.00 | 272.97 |
| CLA80B40T3 | ✓ | 80.0 | 40.0 | 3.0 | 1.317 | 314.00 | 462.00 |
| CLA80B40T5 | ✓ | 80.0 | 40.0 | 5.0 | 2.137 | 308.97 | 749.92 |
| CLSA90B75T13 | * | 90.0 | 75.0 | 13.0 | 6.888 | 450.57 | 2416.87 |
| CLA100B25T3 | ✓ | 100.0 | 25.0 | 3.0 | 1.231 | 292.30 | 431.80 |
| CLA100B50T5 | ✓ | 100.0 | 50.0 | 5.0 | 2.707 | 388.97 | 949.92 |
| CLSA100B60T5.5 | * | 100.0 | 60.0 | 5.5 | 3.429 | 426.00 | 1203.00 |
| CLSA100B85T1.7 | * | 100.0 | 85.0 | 1.7 | 1.158 | 478.96 | 406.31 |
| CLA100B100T5 | * | 100.0 | 100.0 | 5.0 | 4.133 | 589.00 | 1450.00 |
| CLA101.6B12.8T1.1 | * | 101.6 | 12.8 | 1.1 | 0.391 | 251.00 | 137.20 |
| CLSA104B45T8 | * | 104.0 | 45.0 | 8.0 | 4.269 | 372.00 | 1498.00 |
| CLA108B48T2.6 | * | 108.0 | 48.0 | 2.6 | 1.473 | 401.80 | 516.80 |
| CLA110B15T3 | * | 110.0 | 15.0 | 3.0 | 1.148 | 272.28 | 402.79 |
| CLA116B40.5T5 | * | 116.0 | 40.5 | 5.0 | 2.555 | 382.51 | 896.50 |
| CLSA120B85T1.7 | * | 120.0 | 85.0 | 1.7 | 1.255 | 518.95 | 440.31 |

"✓" Stocked Item
 "✱" Pre-order Only Item
 (30-40 working days delivery)



U Channels

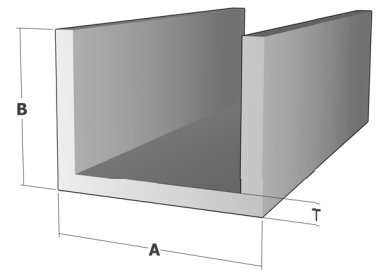

| Product Code | Ex Stock | A (mm) | B (mm) | T (mm) | Mass (kg/m) | Perimeter (mm) | Area (mm ²) |
|---------------------|----------|--------|--------|--------|-------------|----------------|-------------------------|
| CLSA127B69.85T4.83 | * | 127.0 | 69.85 | 4.83 | 4.879 | 514.56 | 1711.77 |
| CLSA150B61T5 | ✓ | 150.0 | 61.0 | 5.0 | 3.734 | 540.00 | 1310.00 |
| CLSA150B65T6.5 | * | 150.0 | 65.0 | 6.5 | 5.068 | 537.64 | 1778.30 |
| CLA150B75T5 | ✓ | 150.0 | 75.0 | 5.0 | 4.132 | 588.30 | 1449.80 |
| CLA152.4B82.6T5.33 | * | 152.4 | 82.6 | 5.33 | 6.299 | 617.80 | 2210.19 |
| CLA153B74T19 | * | 153.0 | 74.0 | 19.0 | 14.229 | 558.85 | 4992.71 |
| CLSA170B100T6 | * | 170.0 | 100.0 | 6.0 | 6.048 | 719.42 | 2122.25 |
| CLA180B52T15 | * | 180.0 | 52.0 | 15.0 | 10.859 | 538.00 | 3810.00 |
| CLA180B120T15 | * | 180.0 | 120.0 | 15.0 | 16.673 | 810.00 | 5850.00 |
| CLSA180B120T15 | * | 180.0 | 120.0 | 15.0 | 15.421 | 811.71 | 5410.73 |
| CLSA200B70T10 | * | 200.0 | 70.0 | 10.0 | 9.242 | 651.42 | 3242.92 |
| CLSA203.2B95.3T6.35 | * | 203.2 | 95.3 | 6.35 | 9.049 | 767.07 | 3175.14 |
| CLSA254B88.9T6.35 | * | 254.0 | 88.9 | 6.35 | 9.592 | 843.30 | 3365.51 |
| CLSA280B53T11 | * | 280.0 | 53.0 | 11.0 | 10.258 | 744.85 | 3599.45 |
| CLSA280B53T21 | * | 280.0 | 53.0 | 21.0 | 18.067 | 742.85 | 6339.45 |
| CLSA300B100T7 | * | 300.0 | 100.0 | 7.0 | 9.696 | 986.00 | 3402.00 |

"✓" Stocked Item
 "✱" Pre-order Only Item
 (30-40 working days delivery)



Flat Bars

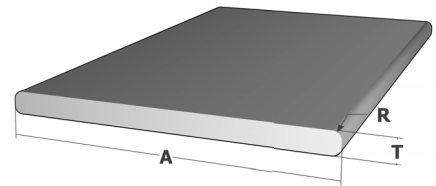

| Product Code | Ex Stock | A (mm) | T (mm) | R (mm) | Mass (kg/m) | Perimeter (mm) | Area (mm ²) |
|-----------------|----------|--------|--------|--------|-------------|----------------|-------------------------|
| FBRA6.9T4.9R2.5 | * | 6.9 | 4.9 | 2.5 | 0.082 | 19.40 | 28.70 |
| FBA7.5T2 | * | 7.5 | 2.0 | | 0.043 | 19.00 | 15.00 |
| FBA8T4 | * | 8.0 | 4.0 | | 0.091 | 24.00 | 32.00 |
| FBA10T2 | * | 10.0 | 2.0 | | 0.057 | 24.00 | 20.00 |
| FBA10T3 | ✓ | 10.0 | 3.0 | | 0.086 | 26.00 | 30.00 |
| FBA10T6 | ✓ | 10.0 | 6.0 | | 0.171 | 32.00 | 60.00 |
| FBA11.4T4.4 | * | 11.4 | 4.4 | | 0.143 | 31.60 | 50.16 |
| FBA12T3 | ✓ | 12.0 | 3.0 | | 0.103 | 30.00 | 36.00 |
| FBA13T6 | * | 13.0 | 6.0 | | 0.222 | 38.00 | 78.00 |
| FBA15T1.6 | * | 15.0 | 1.6 | | 0.068 | 33.20 | 24.00 |
| FBA15T2 | ✓ | 15.0 | 2.0 | | 0.085 | 33.50 | 29.90 |
| FBRA15T2.7R1 | * | 15.0 | 2.7 | 1.0 | 0.113 | 33.70 | 39.64 |
| FBA15T4 | * | 15.0 | 4.0 | | 0.170 | 37.14 | 59.79 |
| FBA16T3 | ✓ | 16.0 | 3.0 | | 0.136 | 37.20 | 47.80 |
| FBRA16T4R4.7 | * | 16.0 | 4.0 | 4.7 | 0.180 | 38.18 | 62.76 |
| FBA18T1.8 | * | 18.0 | 1.8 | | 0.092 | 39.60 | 32.40 |
| FBA19T1.2 | * | 19.0 | 1.2 | | 0.062 | 42.00 | 21.89 |
| FBA19T2 | ✓ | 19.0 | 2.0 | | 0.108 | 42.00 | 38.00 |
| FBA19T3 | * | 19.0 | 3.0 | | 0.162 | 44.00 | 57.00 |
| FBRA19T5R1 | * | 19.0 | 5.0 | 1.0 | 0.268 | 46.28 | 94.14 |
| FBA20T1.5 | ✓ | 20.0 | 1.5 | | 0.086 | 42.50 | 30.00 |
| FBA20T2 | * | 20.0 | 2.0 | | 0.114 | 44.00 | 40.00 |
| FBA20T2.5 | * | 20.0 | 2.5 | | 0.143 | 45.00 | 50.00 |
| FBA20T2.8 | ✓ | 20.0 | 2.8 | | 0.160 | 45.60 | 56.00 |
| FBA20T3 | * | 20.0 | 3.0 | | 0.171 | 46.00 | 60.00 |
| FBA20T5 | * | 20.0 | 5.0 | | 0.285 | 50.00 | 100.00 |
| FBA23T4 | * | 23.0 | 4.0 | | 0.262 | 54.00 | 92.00 |
| FBA20T10 | * | 20.0 | 10.0 | | 0.570 | 60.00 | 200.00 |
| FBA23T10 | * | 23.0 | 10.0 | | 0.656 | 66.00 | 230.00 |
| FBA25T1.5 | * | 25.0 | 1.5 | | 0.107 | 53.00 | 37.50 |
| FBA25T2 | * | 25.0 | 2.0 | | 0.143 | 54.00 | 50.00 |
| FBA25T2.5 | ✓ | 25.0 | 2.5 | | 0.178 | 55.00 | 62.50 |
| FBA25T3 | ✓ | 25.0 | 3.0 | | 0.214 | 55.50 | 74.92 |
| FBA25T4 | * | 25.0 | 4.0 | | 0.285 | 58.40 | 99.90 |
| FBA25T5 | ✓ | 25.0 | 5.0 | | 0.356 | 60.00 | 125.00 |
| FBA25T10 | ✓ | 25.0 | 10.0 | | 0.713 | 70.00 | 250.00 |
| FBA25T20 | * | 25.0 | 20.0 | | 1.425 | 90.00 | 500.00 |
| FBA28T1.5 | * | 28.0 | 1.5 | | 0.119 | 58.50 | 41.90 |
| FBA28T3 | * | 28.0 | 3.0 | | 0.239 | 62.00 | 84.00 |
| FBA28T5.8 | * | 28.0 | 5.8 | | 0.462 | 66.74 | 162.20 |

"✓" Stocked Item
 "✱" Pre-order Only Item
 (30-40 working days delivery)



Flat Bars

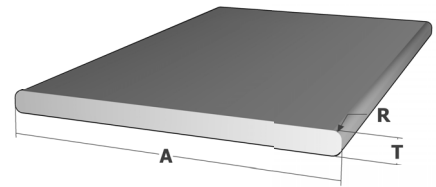

| Product Code | Ex Stock | A (mm) | T (mm) | R(mm) | Mass (kg/m) | Perimeter (mm) | Area (mm ²) |
|------------------|----------|--------|--------|-------|-------------|----------------|-------------------------|
| FBA28T8 | * | 28.0 | 8.0 | | 0.638 | 71.14 | 223.80 |
| FBA28T14 | * | 28.0 | 14.0 | | 1.117 | 83.14 | 391.80 |
| FBA28.3T2 | * | 28.3 | 2.0 | | 0.161 | 60.60 | 56.60 |
| FBA29.5T3.9 | * | 29.5 | 3.9 | | 0.328 | 66.80 | 115.05 |
| FBA30T1.2 | * | 30.0 | 1.2 | | 0.092 | 61.26 | 32.74 |
| FBA30T2 | * | 30.0 | 2.0 | | 0.171 | 64.00 | 60.00 |
| FBA30T2.5 | * | 30.0 | 2.5 | | 0.214 | 65.00 | 75.00 |
| FBA30T3 | ✓ | 30.0 | 3.0 | | 0.257 | 66.00 | 90.00 |
| FBRA30T3R1 | * | 30.0 | 3.0 | 1.0 | 0.254 | 64.28 | 89.14 |
| FBA30T4.8 | ✓ | 30.0 | 4.8 | | 0.410 | 69.60 | 144.00 |
| FBSA30T5 | ✓ | 30.0 | 5.0 | | 0.428 | 70.00 | 150.00 |
| FBRSA32T22R3 | * | 32.0 | 22.0 | 3.0 | 1.995 | 105.00 | 700.03 |
| FBRA34.5T3.8R1 | * | 34.5 | 3.8 | 1.0 | 0.374 | 76.60 | 131.10 |
| FBA35T5 | ✓ | 35.0 | 5.0 | | 0.499 | 80.00 | 175.00 |
| FBRA35T5R1 | ✓ | 35.0 | 5.0 | 1.0 | 0.496 | 78.28 | 174.14 |
| FBA35T20 | * | 35.0 | 20.0 | | 2.000 | 110.00 | 700.00 |
| FBRA37.6T5.5R2.7 | * | 37.6 | 5.5 | 2.7 | 0.571 | 82.00 | 200.30 |
| FBA38T10 | * | 38.0 | 10.0 | | 0.669 | 207.27 | 234.74 |
| FBA38T13 | * | 38.0 | 13.0 | | 1.408 | 102.00 | 494.00 |
| FBRA38.1T3R1.5 | ✓ | 38.1 | 3.0 | 1.5 | 0.326 | 82.20 | 114.30 |
| FBRA38.1T6.3R3.1 | ✓ | 38.1 | 6.3 | 3.1 | 0.684 | 88.80 | 240.03 |
| FBA40T0.9 | * | 40.0 | 0.9 | | 0.103 | 81.80 | 36.00 |
| FBA40T1.5 | * | 40.0 | 1.5 | | 0.171 | 82.50 | 59.92 |
| FBA40T2.9 | ✓ | 40.0 | 2.9 | | 0.331 | 85.80 | 116.00 |
| FBRA40T5R2.5 | * | 40.0 | 5.0 | 2.5 | 0.555 | 85.70 | 194.60 |
| GLX-4532 | ✓ | 40.0 | 5.0 | | 0.570 | 90.00 | 200.00 |
| FBA40T6 | ✓ | 40.0 | 6.0 | | 0.684 | 92.00 | 240.00 |
| FBA40T8.2 | * | 40.0 | 8.2 | | 0.935 | 96.40 | 328.00 |
| FBA40T10 | ✓ | 40.0 | 10.0 | | 1.140 | 100.00 | 400.00 |
| FBA40T15 | ✓ | 40.0 | 15.0 | | 1.710 | 110.00 | 600.00 |
| FBA45T10 | ✓ | 45.0 | 10.0 | | 1.282 | 110.00 | 449.92 |
| FBA45T42 | * | 45.0 | 42.0 | | 5.387 | 174.00 | 1890.00 |
| FBA45.2T3.2 | * | 45.2 | 3.2 | | 0.412 | 96.80 | 144.64 |
| FBA46T2 | * | 46.0 | 2.0 | | 0.262 | 96.00 | 92.00 |
| FBA47.5T1.3 | ✓ | 47.5 | 1.3 | | 0.176 | 97.60 | 61.75 |
| FBA47.6T1.5 | * | 47.6 | 1.5 | | 0.203 | 97.70 | 71.32 |
| FBRA49T5R2.5 | * | 49.0 | 5.0 | 2.5 | 0.695 | 108.00 | 245.00 |
| FBRA50T3R1.5 | * | 50.0 | 3.0 | 1.5 | 0.428 | 106.00 | 150.00 |
| FBA50T3 | ✓ | 50.0 | 3.0 | | 0.428 | 106.00 | 150.00 |
| FBA50T3.5 | * | 50.0 | 3.5 | | 0.500 | 107.00 | 175.00 |

"✓" Stocked Item
 "✱" Pre-order Only Item
 (30-40 working days delivery)



Flat Bars

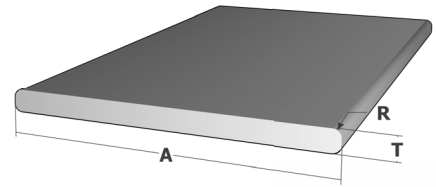

| Product Code | Ex Stock | A (mm) | T (mm) | R(mm) | Mass (kg/m) | Perimeter (mm) | Area (mm ²) |
|--------------|----------|--------|--------|-------|-------------|----------------|-------------------------|
| FBA50T4 | * | 50.0 | 4.0 | | 0.570 | 108.00 | 200.00 |
| FBA50T5 | * | 50.0 | 5.0 | | 0.713 | 110.00 | 250.00 |
| FBA50T6 | ✓ | 50.0 | 6.0 | | 0.855 | 112.00 | 300.00 |
| FBRA50T6R3 | * | 50.0 | 6.0 | 3.0 | 0.855 | 112.00 | 300.00 |
| FBA50T10 | ✓ | 50.0 | 10.0 | | 1.425 | 120.00 | 500.00 |
| FBA50T12 | ✓ | 50.0 | 12.0 | | 1.710 | 124.00 | 600.00 |
| FBA50T20 | ✓ | 50.0 | 20.0 | | 2.850 | 140.00 | 1000.00 |
| FBA50T25 | ✓ | 50.0 | 25.0 | | 3.563 | 150.00 | 1250.00 |
| FBA55T1.7 | * | 55.0 | 1.7 | | 0.266 | 113.40 | 93.50 |
| FBSA55T5 | * | 55.0 | 5.0 | | 0.784 | 120.00 | 275.00 |
| FBSA55T8 | * | 55.0 | 8.0 | | 1.254 | 125.50 | 439.92 |
| FBA56.5T27 | * | 56.5 | 27.0 | | 4.344 | 164.77 | 1524.05 |
| FBA57.6T2.8 | * | 57.6 | 2.8 | | 0.460 | 120.80 | 161.28 |
| FBA58T4 | * | 58.0 | 4.0 | | 0.661 | 124.00 | 232.00 |
| FBA60T0.9 | * | 60.0 | 0.9 | | 0.154 | 121.80 | 54.00 |
| FBA60T3 | ✓ | 60.0 | 3.0 | | 0.512 | 125.20 | 179.80 |
| FBA60T4 | * | 60.0 | 4.0 | | 0.684 | 128.00 | 240.00 |
| FBA60T5 | ✓ | 60.0 | 5.0 | | 0.855 | 130.00 | 300.00 |
| FBA60T6 | ✓ | 60.0 | 6.0 | | 1.026 | 132.00 | 360.00 |
| FBA60T10 | ✓ | 60.0 | 10.0 | | 1.710 | 140.00 | 600.00 |
| FBA60T12 | ✓ | 60.0 | 12.0 | | 2.052 | 144.00 | 720.00 |
| FBRA64T5R2.5 | * | 64.0 | 5.0 | 2.5 | 0.911 | 135.70 | 319.60 |
| FBA65T8 | * | 65.0 | 8.0 | | 1.482 | 146.00 | 520.00 |
| FBA70T2 | * | 70.0 | 2.0 | | 0.399 | 144.00 | 140.00 |
| FBA70T4 | * | 70.0 | 4.0 | | 0.789 | 147.50 | 279.92 |
| FBA70T10 | ✓ | 70.0 | 10.0 | | 1.995 | 160.00 | 700.00 |
| FBA70T15 | * | 70.0 | 15.0 | | 2.993 | 170.00 | 1050.00 |
| FBA75T2 | ✓ | 75.0 | 2.0 | | 0.428 | 154.00 | 150.00 |
| FBA75T4 | ✓ | 75.0 | 4.0 | | 0.855 | 158.00 | 300.00 |
| FBA75T6 | ✓ | 75.0 | 6.0 | | 1.283 | 162.00 | 450.00 |
| FBA75T10 | ✓ | 75.0 | 10.0 | | 2.138 | 170.00 | 750.00 |
| FBA75T12 | ✓ | 75.0 | 12.0 | | 2.565 | 174.00 | 900.00 |
| FBA75T20 | ✓ | 75.0 | 20.0 | | 4.275 | 190.00 | 1500.00 |
| FBA77T6 | * | 77.0 | 6.0 | | 1.317 | 165.50 | 462.00 |
| FBA80T6 | ✓ | 80.0 | 6.0 | | 1.368 | 172.00 | 480.00 |
| FBA80T10 | ✓ | 80.0 | 10.0 | | 2.280 | 180.00 | 800.00 |
| FBA80T12 | ✓ | 80.0 | 12.0 | | 2.736 | 184.00 | 960.00 |
| FBA84T4 | * | 84.0 | 4.0 | | 0.958 | 176.00 | 336.00 |
| FBA84T5 | * | 84.0 | 5.0 | | 1.197 | 177.48 | 419.92 |
| FBA84T6 | * | 84.0 | 6.0 | | 1.436 | 180.00 | 504.00 |

"✓" Stocked Item
 "✱" Pre-order Only Item
 (30-40 working days delivery)



Flat Bars

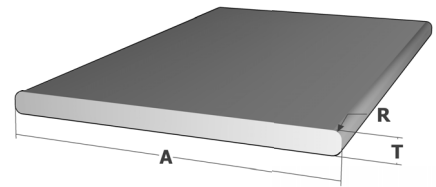

| Product Code | Ex Stock | A (mm) | T (mm) | R (mm) | Mass (kg/m) | Perimeter (mm) | Area (mm ²) |
|-----------------|----------|--------|--------|--------|-------------|----------------|-------------------------|
| FBA88T5 | * | 88.0 | 5.0 | | 1.254 | 185.50 | 440.00 |
| FBA90T3 | ✓ | 90.0 | 3.0 | | 0.769 | 185.50 | 269.92 |
| FBRA90T5R2.5 | ✓ | 90.0 | 5.0 | 2.5 | 1.267 | 185.70 | 444.60 |
| FBRA90T6R3 | ✓ | 90.0 | 6.0 | 3.0 | 1.517 | 186.90 | 532.30 |
| FBA95T3.5 | * | 95.0 | 3.5 | | 0.950 | 197.00 | 332.40 |
| FBA96T6 | * | 96.0 | 6.0 | | 1.950 | 204.00 | 576.00 |
| FBA100T1.5 | * | 100.0 | 1.5 | | 0.430 | 203.00 | 150.00 |
| FBA100T3 | ✓ | 100.0 | 3.0 | | 0.855 | 206.00 | 300.00 |
| FBA100T3 | * | 100.0 | 4.0 | | 1.140 | 208.00 | 400.00 |
| FBA100T6 | ✓ | 100.0 | 6.0 | | 1.709 | 211.20 | 599.80 |
| FBA100T8 | * | 100.0 | 8.0 | | 2.280 | 216.00 | 800.00 |
| FBA100T10 | ✓ | 100.0 | 10.0 | | 2.850 | 220.00 | 1000.00 |
| FBRA100T10R5 | * | 100.0 | 10.0 | 5.0 | 2.789 | 211.42 | 978.54 |
| FBA100T12 | ✓ | 100.0 | 12.0 | | 3.420 | 224.00 | 1200.00 |
| FBA106T6 | * | 106.0 | 6.0 | | 1.813 | 224.00 | 636.00 |
| FBA110T2 | * | 110.0 | 2.0 | | 0.627 | 224.00 | 220.00 |
| FBA110T8 | ✓ | 110.0 | 8.0 | | 2.508 | 236.00 | 880.00 |
| FBA116T6 | * | 116.0 | 6.0 | | 1.984 | 224.00 | 696.00 |
| FBA117T3.7 | * | 117.0 | 3.7 | | 1.234 | 241.40 | 432.90 |
| FBRA119T5R2.5 | * | 119.0 | 5.0 | 2.5 | 1.682 | 243.70 | 590.00 |
| FBA120T6 | ✓ | 120.0 | 6.0 | | 2.052 | 252.00 | 720.00 |
| FBRA120T6R3 | ✓ | 120.0 | 6.0 | 3.0 | 2.030 | 246.90 | 712.30 |
| FBA120T8 | * | 120.0 | 8.0 | | 2.736 | 256.00 | 960.00 |
| FBA120T12 | * | 120.0 | 12.0 | | 4.104 | 264.00 | 1440.00 |
| FBA123T4.8 | * | 123.0 | 4.8 | | 1.683 | 255.60 | 590.40 |
| FBA123T5.5 | * | 123.0 | 5.5 | | 1.928 | 257.00 | 676.50 |
| FBA123T3.5 | * | 123.0 | 3.5 | | 1.227 | 253.00 | 430.50 |
| FBA125T6 | ✓ | 125.0 | 6.0 | | 2.138 | 262.00 | 750.00 |
| FBA125T10 | ✓ | 125.0 | 10.0 | | 3.563 | 270.00 | 1250.00 |
| FBA125T12 | ✓ | 125.0 | 12.0 | | 4.275 | 274.00 | 1500.00 |
| FBA126T6 | * | 126.0 | 6.0 | | 2.155 | 264.00 | 756.00 |
| FBA133.5T6 | * | 133.5 | 6.0 | | 2.283 | 279.00 | 801.00 |
| FBA136T4 | * | 136.0 | 4.0 | | 1.550 | 280.00 | 544.00 |
| FBA136T6 | * | 136.0 | 6.0 | | 2.326 | 284.00 | 816.00 |
| FBA138T5.8 | ✓ | 138.0 | 5.8 | | 2.281 | 287.60 | 800.40 |
| FBRA140T5.9R2.9 | * | 140.0 | 5.9 | 2.9 | 2.333 | 286.70 | 818.50 |
| FBA140T10 | * | 140.0 | 10.0 | | 3.990 | 300.00 | 1400.00 |
| FBA142T3.6 | * | 142.0 | 3.6 | | 1.457 | 291.20 | 511.20 |
| FBA143T25 | * | 143.0 | 25.0 | | 10.189 | 336.00 | 3575.00 |
| FBA145T6 | ✓ | 145.0 | 6.0 | | 2.480 | 302.00 | 870.00 |

"✓" Stocked Item
 "✱" Pre-order Only Item
 (30-40 working days delivery)



Flat Bars

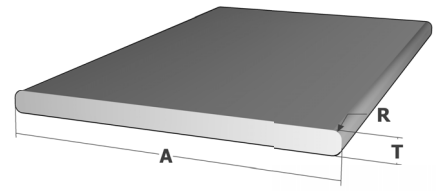

| Product Code | Ex Stock | A (mm) | T (mm) | R (mm) | Mass (kg/m) | Perimeter (mm) | Area (mm ²) |
|-----------------|----------|--------|--------|--------|-------------|----------------|-------------------------|
| FBA150T3 | ✓ | 150.0 | 3.0 | | 1.283 | 306.00 | 450.00 |
| FBA150T5 | ✓ | 150.0 | 5.0 | | 2.138 | 310.00 | 750.00 |
| FBA150T8 | ✱ | 150.0 | 8.0 | | 3.420 | 316.00 | 1200.00 |
| FBA150T10 | ✓ | 150.0 | 10.0 | | 4.275 | 319.50 | 1500.00 |
| FBA150T13.5 | ✓ | 150.0 | 13.5 | | 5.771 | 327.00 | 2025.00 |
| FBA151T3.2 | ✱ | 151.0 | 3.2 | | 1.377 | 308.40 | 483.20 |
| FBA151T4.8 | ✱ | 151.0 | 4.8 | | 2.066 | 311.60 | 724.80 |
| FBA151T5.8 | ✱ | 151.0 | 5.8 | | 2.496 | 313.60 | 875.80 |
| FBA151T3.7 | ✱ | 151.0 | 3.7 | | 1.592 | 309.40 | 558.70 |
| FBRA160T5.9R2.9 | ✱ | 160.0 | 5.9 | 2.9 | 2.670 | 427.00 | 937.00 |
| FBA160T10 | ✓ | 160.0 | 10.0 | | 4.560 | 340.00 | 1600.00 |
| FBA160T20 | ✱ | 160.0 | 20.0 | | 9.120 | 360.00 | 3200.00 |
| FBA160T25 | ✱ | 160.0 | 25.0 | | 11.400 | 370.00 | 4000.00 |
| FBA160T27 | ✱ | 160.0 | 27.0 | | 12.466 | 378.00 | 4374.00 |
| FBA200T5 | ✓ | 200.0 | 5.0 | | 2.850 | 410.00 | 1000.00 |
| FBA200T10 | ✓ | 200.0 | 10.0 | | 5.700 | 420.00 | 2000.00 |
| FBA200T11 | ✓ | 200.0 | 11.0 | | 6.270 | 422.00 | 2200.00 |
| FBRA209T5.9R2.9 | ✱ | 209.0 | 5.9 | 2.9 | 3.493 | 424.70 | 1225.60 |
| FBA220T5 | ✓ | 220.0 | 5.0 | | 3.135 | 450.00 | 1100.00 |
| FBA222T1.8 | ✱ | 222.0 | 1.8 | | 1.139 | 447.60 | 399.60 |
| FBA270T6 | ✱ | 270.0 | 6.0 | | 4.617 | 552.00 | 1620.00 |
| FBA270T9 | ✓ | 270.0 | 9.0 | | 6.926 | 558.00 | 2430.00 |
| FBA270T14 | ✱ | 270.0 | 14.0 | | 10.773 | 568.00 | 3780.00 |
| FBA300T4 | ✱ | 300.0 | 4.0 | | 3.420 | 608.00 | 1200.00 |
| FBA300T10 | ✓ | 300.0 | 10.0 | | 8.550 | 619.50 | 2999.92 |

"✓" Stocked Item
 "✱" Pre-order Only Item
 (30-40 working days delivery)



Tee Bars

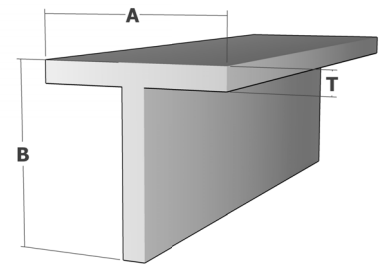

| Product Code | Ex Stock | A (mm) | B (mm) | T (mm) | Mass (kg/m) | Perimeter (mm) | Area (mm ²) |
|-------------------|----------|--------|--------|--------|-------------|----------------|-------------------------|
| TBA15B15T1.5 | ✱ | 15.0 | 15.0 | 1.5 | 0.122 | 60.00 | 42.75 |
| TBA15B80T3 | ✱ | 15.0 | 80.0 | 3.0 | 0.787 | 190.00 | 276.00 |
| TBA19B19T3.2 | ✓ | 19.0 | 19.0 | 3.2 | 0.316 | 76.71 | 110.89 |
| TBA15B35T1.1 | ✱ | 15.0 | 35.0 | 1.1 | 0.153 | 98.97 | 53.71 |
| TBA20B10T1.5 | ✓ | 20.0 | 10.0 | 1.5 | 0.122 | 59.00 | 42.68 |
| TBA20B11.5T4 | ✓ | 20.0 | 11.5 | 4.0 | 0.292 | 62.00 | 102.42 |
| TBA20B20T1.5 | ✓ | 20.0 | 20.0 | 1.5 | 0.165 | 80.00 | 57.75 |
| TBSA22.8B42.7T1 | ✱ | 22.8 | 42.7 | 1.0 | 0.189 | 129.37 | 66.35 |
| TBA25B25T3 | ✓ | 25.0 | 25.0 | 3.0 | 0.401 | 98.30 | 140.80 |
| TBSA30B40T4 | ✱ | 30.0 | 40.0 | 4.0 | 0.763 | 137.44 | 267.86 |
| TBSA35.8B68T2.8 | ✱ | 35.8 | 68.0 | 2.8 | 1.139 | 231.00 | 399.50 |
| TBSA35.8B78T2.8 | ✱ | 35.8 | 78.0 | 2.8 | 1.269 | 253.80 | 445.30 |
| TBSA35.8B88T2.8 | ✱ | 35.8 | 88.0 | 2.8 | 1.400 | 277.00 | 491.20 |
| TBSA35.8B98T2.8 | ✱ | 35.8 | 98.0 | 2.8 | 1.530 | 300.00 | 537.00 |
| TBSA37B53.7T3.7 | ✱ | 37.0 | 53.7 | 3.7 | 0.908 | 184.00 | 318.76 |
| TBA40B20T1.5 | ✓ | 40.0 | 20.0 | 1.5 | 0.250 | 118.30 | 87.60 |
| TBA40B40T3 | ✓ | 40.0 | 40.0 | 3.0 | 0.658 | 158.30 | 230.80 |
| TBA40B40T6 | ✓ | 40.0 | 40.0 | 6.0 | 1.265 | 158.30 | 443.80 |
| TBA40B50T6 | ✓ | 40.0 | 50.0 | 6.0 | 1.436 | 178.30 | 503.80 |
| TBSA41B32T1.5 | ✓ | 41.0 | 32.0 | 1.5 | 0.353 | 143.00 | 123.90 |
| TBSA45B25T2.5 | ✱ | 45.0 | 25.0 | 2.5 | 0.481 | 139.23 | 168.63 |
| TBA50B50T3 | ✓ | 50.0 | 50.0 | 3.0 | 0.829 | 199.00 | 290.92 |
| TBA50B50T6 | ✓ | 50.0 | 50.0 | 6.0 | 1.607 | 198.30 | 563.80 |
| TBA50B100T6 | ✓ | 50.0 | 100.0 | 6.0 | 2.462 | 298.30 | 863.80 |
| TBA51B62T16.7 | ✱ | 51.0 | 62.0 | 16.7 | 4.207 | 225.15 | 1476.17 |
| TBA55B55T3 | ✱ | 55.0 | 55.0 | 3.0 | 0.915 | 220.00 | 321.00 |
| TBSA60B30T4.5 | ✱ | 60.0 | 30.0 | 4.5 | 1.351 | 179.00 | 473.92 |
| TBSA60B30T5.5 | ✱ | 60.0 | 30.0 | 5.5 | 1.499 | 179.00 | 525.92 |
| TBSA60B60T6 | ✓ | 60.0 | 60.0 | 6.0 | 1.949 | 240.00 | 684.00 |
| TBA60B70T2 | ✱ | 60.0 | 70.0 | 2.0 | 0.729 | 259.00 | 255.92 |
| TBA63.5B63.5T6.35 | ✓ | 63.5 | 63.5 | 6.35 | 2.183 | 252.30 | 766.00 |
| TBA65B123T2.2 | ✓ | 65.0 | 123.0 | 2.2 | 1.125 | 373.08 | 394.86 |
| TBA75B75T6 | ✓ | 75.0 | 75.0 | 6.0 | 2.462 | 298.30 | 863.80 |
| TBA101B60T4 | ✱ | 101.0 | 60.0 | 4.0 | 1.809 | 318.57 | 634.87 |
| TBA120B84T4 | ✱ | 120.0 | 84.0 | 4.0 | 2.280 | 406.97 | 800.00 |
| TBA150B100T8 | ✓ | 150.0 | 100.0 | 8.0 | 5.518 | 500.00 | 1936.00 |

"✓" Stocked Item
 "✱" Pre-order Only Item
 (30-40 working days delivery)



Solid Rounds

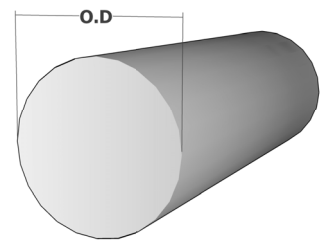

| Product Code | Ex Stock | O.D (mm) | Mass (kg/m) | Perimeter (mm) | Grade & Temper |
|--------------|----------|----------|-------------|----------------|----------------|
| SRD4.4L3 | * | 4.4 | 0.043 | 13.82 | 6061-T6 |
| SRD5L3 | * | 5.0 | 0.056 | 15.71 | 6061-T6 |
| SRD5.3L3 | * | 5.3 | 0.063 | 16.65 | 6061-T6 |
| SRD6L3 | * | 6.0 | 0.081 | 18.90 | 6061-T6 |
| SRD6.3L3 | ✓ | 6.3 | 0.089 | 19.79 | 6061-T6 |
| SRD6.8L3 | * | 6.8 | 0.104 | 21.36 | 6061-T6 |
| SRD7L3 | ✓ | 7.0 | 0.110 | 21.99 | 6061-T6 |
| SRD8L3 | ✓ | 8.0 | 0.143 | 25.13 | 6061-T6 |
| SRD9.53L3 | ✓ | 9.53 | 0.203 | 30.00 | 6061-T6 |
| SRD9.7L3 | * | 9.7 | 0.211 | 30.50 | 6061-T6 |
| SRD10L3 | * | 10.0 | 0.224 | 31.42 | 6061-T6 |
| SRD10.5L3 | * | 10.5 | 0.247 | 32.99 | 6061-T6 |
| SRD11L3 | ✓ | 11.0 | 0.271 | 34.56 | 6061-T6 |
| SRD11.8L3 | * | 11.8 | 0.312 | 37.10 | 6061-T6 |
| SRD12L3 | * | 12.0 | 0.322 | 37.70 | 6061-T6 |
| SRD12.7L3 | ✓ | 12.7 | 0.361 | 40.00 | 6061-T6 |
| SRD13L3 | * | 13.0 | 0.378 | 40.84 | 6061-T6 |
| SRD14L3 | * | 14.0 | 0.439 | 44.00 | 6061-T6 |
| SRD15L3 | ✓ | 15.0 | 0.504 | 47.12 | 6061-T6 |
| SRD15.6L3 | * | 15.6 | 0.545 | 49.00 | 6061-T6 |
| SRD16L3 | ✓ | 16.0 | 0.573 | 50.27 | 6061-T6 |
| SRD17L3 | * | 17.0 | 0.647 | 53.40 | 6061-T6 |
| SRD18L3 | ✓ | 18.0 | 0.725 | 56.55 | 6061-T6 |
| SRD19L3 | ✓ | 19.0 | 0.808 | 59.70 | 6061-T6 |
| SRD20L3 | ✓ | 20.0 | 0.895 | 62.80 | 6061-T6 |
| SRD21L3 | * | 21.0 | 0.987 | 66.00 | 6061-T6 |
| SRD22L3 | ✓ | 22.0 | 1.083 | 69.12 | 6061-T6 |
| SRD23L3 | * | 23.0 | 1.184 | 72.26 | 6061-T6 |
| SRD24L3 | ✓ | 24.0 | 1.289 | 75.40 | 6061-T6 |
| SRD25L3 | * | 25.0 | 1.399 | 78.54 | 6061-T6 |
| SRD25.4L3 | ✓ | 25.4 | 1.444 | 79.80 | 6061-T6 |
| SRD26L3 | * | 26.0 | 1.513 | 81.70 | 6061-T6 |
| SRD26.2L3 | * | 26.2 | 1.537 | 82.31 | 6061-T6 |
| SRD26.5L3 | ✓ | 26.5 | 1.572 | 83.25 | 6061-T6 |
| SRD27L3 | ✓ | 27.0 | 1.623 | 84.80 | 6061-T6 |
| SRD28L3 | * | 28.0 | 1.755 | 88.00 | 6061-T6 |
| SRD29L3 | ✓ | 29.0 | 1.882 | 91.11 | 6061-T6 |
| SRD32L3 | ✓ | 32.0 | 2.292 | 100.53 | 6061-T6 |
| SRD33L3 | * | 33.0 | 2.438 | 103.67 | 6061-T6 |
| SRD34L3 | * | 34.0 | 2.588 | 106.81 | 6061-T6 |

"✓" Stocked Item
 "✱" Pre-order Only Item
 (30-40 working days delivery)



Solid Rounds

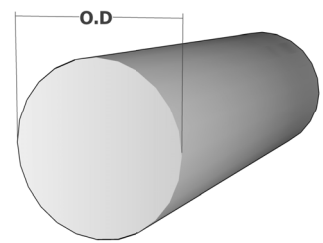

| Product Code | Ex Stock | O.D (mm) | Mass (kg/m) | Perimeter (mm) | Grade & Temper |
|--------------|----------|----------|-------------|----------------|----------------|
| SRD35L3 | ✱ | 35.0 | 2.742 | 109.96 | 6061-T6 |
| SRD36L3 | ✱ | 36.0 | 2.901 | 113.10 | 6061-T6 |
| SRD37.5L3 | ✱ | 37.5 | 3.148 | 117.81 | 6061-T6 |
| SRD38.1L3 | ✓ | 38.1 | 3.249 | 119.70 | 6061-T6 |
| SRD39.5L3 | ✱ | 39.5 | 3.492 | 124.10 | 6061-T6 |
| SRD40L3 | ✓ | 40.0 | 3.581 | 125.66 | 6061-T6 |
| SRD41.28L3 | ✓ | 41.28 | 3.814 | 129.70 | 6061-T6 |
| SRD42L3 | ✱ | 42.0 | 3.949 | 131.95 | 6061-T6 |
| SRD42.8L3 | ✱ | 42.8 | 4.100 | 134.46 | 6061-T6 |
| SRD44.5L3 | ✓ | 44.5 | 4.423 | 139.70 | 6061-T6 |
| SRD47.7L3 | ✱ | 47.7 | 5.093 | 149.90 | 6061-T6 |
| SRD50L3 | ✱ | 50.0 | 5.596 | 157.08 | 6061-T6 |
| SRD50.8L3 | ✓ | 50.8 | 5.777 | 159.60 | 6061-T6 |
| SRD54L3 | ✓ | 54.0 | 6.527 | 169.70 | 6061-T6 |
| SRD55L3 | ✓ | 55.0 | 6.771 | 172.79 | 6061-T6 |
| SRD59.9L3 | ✓ | 59.9 | 8.031 | 188.18 | 6061-T6 |
| SRD60.32L3 | ✓ | 60.32 | 8.144 | 189.50 | 6061-T6 |
| SRD64L3 | ✓ | 64.0 | 9.168 | 201.10 | 6061-T6 |
| SRD65L3 | ✓ | 65.0 | 9.457 | 204.20 | 6061-T6 |
| SRD69.5L3 | ✓ | 69.5 | 10.812 | 177.12 | 6061-T6 |
| SRD70L3 | ✓ | 70.0 | 10.968 | 219.91 | 6061-T6 |
| SRD76.2L3 | ✓ | 75.0 | 12.315 | 239.39 | 6061-T6 |
| SRD80L3 | ✓ | 80.0 | 14.326 | 251.33 | 6061-T6 |
| SRD85L3 | ✓ | 85.0 | 16.172 | 267.04 | 6061-T6 |
| SRD90L3 | ✓ | 90.0 | 16.820 | 279.29 | 6061-T6 |
| SRD95L3 | ✓ | 95.0 | 20.201 | 298.45 | 6061-T6 |
| SRD100L3 | ✓ | 100.0 | 22.384 | 314.16 | 6061-T6 |
| SRD105L3 | ✓ | 105.0 | 24.678 | 329.87 | 6061-T6 |
| SRD110L3 | ✓ | 110.0 | 27.084 | 345.58 | 6061-T6 |
| SRD115L3 | ✓ | 115.0 | 29.603 | 361.28 | 6061-T6 |
| SRD120L3 | ✓ | 120.0 | 32.233 | 376.99 | 6061-T6 |
| SRD125L3 | ✓ | 125.0 | 34.975 | 392.70 | 6061-T6 |
| SRD127L3 | ✓ | 127.0 | 34.210 | 398.98 | 6061-T6 |
| SRD150L3 | ✓ | 150.0 | 49.260 | 478.78 | 6061-T6 |
| SRD165L3 | ✓ | 165.0 | 60.940 | 518.36 | 6061-T6 |
| SRD200L3 | ✓ | 200.0 | 89.535 | 628.32 | 6061-T6 |
| SRD203L3 | ✓ | 203.0 | 92.242 | 637.74 | 6061-T6 |
| SRD250L3 | ✓ | 250.0 | 139.900 | 785.40 | 6061-T6 |
| SRD280L3 | ✓ | 280.0 | 175.489 | 879.65 | 6061-T6 |

"✓" Stocked Item
 "✱" Pre-order Only Item
 (30-40 working days delivery)



Solid Square

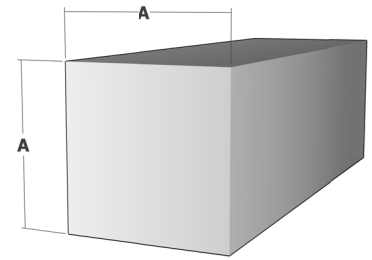

| Product Code | Ex Stock | A (mm) | Mass (kg/m) | Perimeter (mm) | Grade & Temper |
|--------------|----------|--------|-------------|----------------|----------------|
| SQBA6.3L3 | ✓ | 6.3 | 0.113 | 25.20 | 6061-T6 |
| SQBA8L3 | ✱ | 8.0 | 0.175 | 29.00 | 6061-T6 |
| SQBA10L3 | ✓ | 10.0 | 0.284 | 39.10 | 6061-T6 |
| SQBA12L3 | ✓ | 12.0 | 0.401 | 47.10 | 6061-T6 |
| SQBA16L3 | ✓ | 16.0 | 0.729 | 63.10 | 6061-T6 |
| SQBA19L3 | ✓ | 19.0 | 1.034 | 75.30 | 6061-T6 |
| SQBA20L3 | ✓ | 20.0 | 1.139 | 79.10 | 6061-T6 |
| SQBA25L3 | ✓ | 25.0 | 1.781 | 99.10 | 6061-T6 |
| SQBA31.8L3 | ✓ | 31.8 | 2.881 | 126.30 | 6061-T6 |
| SQBA33L3 | ✓ | 33.0 | 3.104 | 132.00 | 6061-T6 |
| SQBA38.1L3 | ✓ | 38.1 | 4.136 | 151.40 | 6061-T6 |
| SQBA40L3 | ✓ | 40.0 | 4.560 | 160.00 | 6061-T6 |
| SQBA42L3 | ✓ | 42.0 | 5.027 | 168.00 | 6061-T6 |
| SQBA44.5L3 | ✓ | 44.5 | 5.643 | 177.10 | 6061-T6 |
| SQBA51L3 | ✓ | 51.0 | 7.413 | 201.00 | 6061-T6 |
| SQBA60L3 | ✓ | 60.0 | 10.260 | 240.00 | 6061-T6 |
| SQBA100L3 | ✓ | 100.0 | 28.500 | 400.00 | 6061-T6 |

"✓" Stocked Item
 "*" Pre-order Only Item
 (30-40 working days delivery)



Flat Sheet

5005 - H34

General Purpose

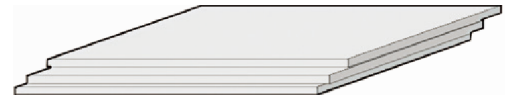

| Product Code | Ex Stock | Thickness (mm) | Length (mm) | Width (mm) | Weight (kg) |
|---------------|----------|----------------|-------------|------------|-------------|
| 5005AS071224 | ✓ | 0.70 | 1200 | 2400 | 5.53 |
| 5005AS0751224 | ✓ | 0.75 | 1200 | 2400 | 5.93 |
| 5005AS091224 | ✓ | 0.90 | 1200 | 2400 | 7.12 |
| 5005AS091530 | ✓ | 0.90 | 1500 | 3000 | 11.13 |
| 5005AS121224 | ✓ | 1.20 | 1200 | 2400 | 9.48 |
| 5005AS121530 | ✓ | 1.20 | 1500 | 3000 | 14.81 |
| 5005AS15153 | ✓ | 1.50 | 1500 | 3000 | 18.90 |
| 5005AS161224 | ✓ | 1.60 | 1200 | 2400 | 12.72 |
| 5005AS16153 | ✓ | 1.60 | 1500 | 3000 | 20.30 |
| 5005AS161236 | ✓ | 1.60 | 1200 | 3600 | 18.80 |
| 5005AS21224 | ✓ | 2.00 | 1200 | 2400 | 16.13 |
| 5005AS2153 | ✓ | 2.00 | 1500 | 3000 | 25.17 |
| 5005AS251224 | ✓ | 2.50 | 1200 | 2400 | 20.14 |
| 5005AS31224 | ✓ | 3.00 | 1200 | 2400 | 23.88 |
| 5005AS3153 | ✓ | 3.00 | 1500 | 3000 | 37.86 |
| 5005AS31836 | ✓ | 3.00 | 1800 | 3600 | 54.52 |
| 5005AS41224 | ✓ | 4.00 | 1200 | 2400 | 31.91 |
| 5005AS4153 | ✓ | 4.00 | 1500 | 3000 | 50.79 |
| 5005AS51224 | ✓ | 5.00 | 1200 | 2400 | 39.73 |
| 5005AS5153 | ✓ | 5.00 | 1500 | 3000 | 64.32 |
| 5005AS61224 | ✓ | 6.00 | 1200 | 2400 | 47.71 |

Flat Sheet

5083 - H116

Hard Marine & Transport

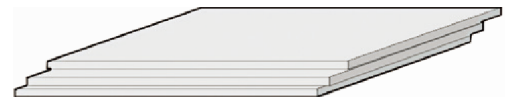

| Product Code | Ex Stock | Thickness (mm) | Length (mm) | Width (mm) | Weight (kg) |
|--------------|----------|----------------|-------------|------------|-------------|
| 5083AS31224 | * | 3.00 | 1200 | 2400 | 22.95 |
| 5083AS41224 | ✓ | 4.00 | 1200 | 2400 | 30.60 |
| 5083AS51224 | ✓ | 5.00 | 1200 | 2400 | 38.20 |
| 5083AS61224 | * | 6.00 | 1200 | 2400 | 45.90 |
| 5083AS81224 | * | 8.00 | 1200 | 2400 | 61.20 |
| 5083AS101224 | * | 10.00 | 1200 | 2400 | 76.50 |
| 5083AS121224 | * | 12.00 | 1200 | 2400 | 91.80 |

"✓" Stocked Item
 "✱" Pre-order Only Item
 (30-40 working days delivery)



Flat Sheet

6061 - T6
 Structural

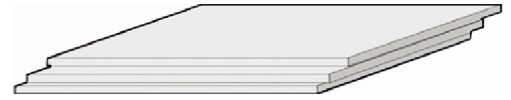

| Product Code | Ex Stock | Thickness (mm) | Length (mm) | Width (mm) | Weight (kg) |
|---------------|----------|----------------|-------------|------------|-------------|
| 6061AS412525 | ✓ | 4.00 | 1250 | 2500 | 34.00 |
| 6061AS512525 | ✓ | 5.00 | 1250 | 2500 | 42.50 |
| 6061AS612525 | ✓ | 6.00 | 1250 | 2500 | 54.20 |
| 6061AS812525 | ✓ | 8.00 | 1250 | 2500 | 71.45 |
| 6061AS8153 | ✓ | 8.00 | 1500 | 3000 | 107.91 |
| 6061AS1012525 | ✓ | 10.00 | 1250 | 2500 | 90.92 |
| 6061AS101530 | ✓ | 10.00 | 1500 | 3000 | 130.92 |
| 6061AS1212525 | ✓ | 12.00 | 1250 | 2500 | 103.00 |

Flat Sheet

5052 - H32
 Marine Grade

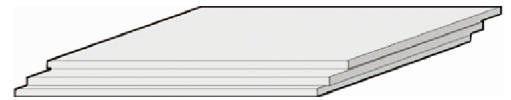

| Product Code | Ex Stock | Thickness (mm) | Length (mm) | Width (mm) | Weight (kg) |
|--------------|----------|----------------|-------------|------------|-------------|
| 5052AS071224 | ✓ | 0.70 | 1200 | 2400 | 5.48 |
| 5052AS161224 | ✓ | 1.60 | 1200 | 2400 | 12.53 |
| 5052AS16153 | ✓ | 1.60 | 1500 | 3000 | 19.58 |
| 5052AS21224 | ✓ | 2.00 | 1200 | 2400 | 16.18 |
| 5052AS2153 | ✓ | 2.00 | 1500 | 3000 | 25.28 |
| 5052AS251224 | ✓ | 2.50 | 1200 | 2400 | 20.23 |
| 5052AS31224 | ✓ | 3.00 | 1200 | 2400 | 24.35 |
| 5052AS3153 | ✓ | 3.00 | 1500 | 3000 | 38.05 |
| 5052AS41224 | ✓ | 4.00 | 1200 | 2400 | 31.62 |
| 5052AS51224 | ✓ | 5.00 | 1200 | 2400 | 39.53 |
| 5052AS61224 | ✓ | 6.00 | 1200 | 2400 | 47.44 |

"✓" Stocked Item
 "✱" Pre-order Only Item
 (30-40 working days delivery)



Standard Treadplate

5052 - H32

5 Bar Pattern



| Product Code | Ex Stock | Thickness (mm) | Length (mm) | Width (mm) | Weight (kg) |
|--------------|----------|----------------|-------------|------------|-------------|
| 5052TP15153 | ✓ | 1.50 | 1500 | 3000 | 18.90 |
| 5052TP161224 | ✓ | 1.60 | 1200 | 2400 | 13.82 |
| 5052TP21224 | ✓ | 2.00 | 1200 | 2400 | 17.06 |
| 5052TP251224 | ✓ | 2.50 | 1200 | 2400 | 21.67 |
| 5052TP31224 | ✓ | 3.00 | 1200 | 2400 | 25.89 |
| 5052TP3153 | ✓ | 3.00 | 1500 | 3000 | 40.25 |
| 5052TP41224 | ✓ | 4.00 | 1200 | 2400 | 33.41 |
| 5052TP4153 | ✓ | 4.00 | 1500 | 3000 | 52.20 |
| 5052TP51224 | ✓ | 5.00 | 1200 | 2400 | 41.76 |
| 5052TP5153 | ✓ | 5.00 | 1500 | 3000 | 65.25 |
| 5052TP61224 | ✓ | 6.00 | 1200 | 2400 | 50.11 |
| 5052TP6153 | ✓ | 6.00 | 1500 | 3000 | 77.16 |
| 5052TP81224 | ✓ | 8.00 | 1200 | 2400 | 66.81 |

Honeycomb Panel

Powdercoated both sides of surfaces

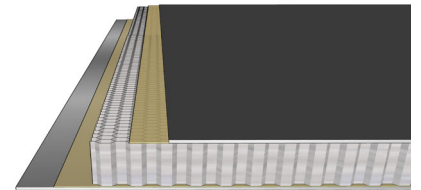

| Product Code | Ex Stock | Thickness (mm) | Length (mm) | Width (mm) | Colour |
|-------------------|----------|----------------|-------------|------------|-------------|
| HS1712525MF | ✓ | 17.00 | 1250 | 2500 | Mill Finish |
| HS1712525Ironsand | ✓ | 17.00 | 1250 | 2500 | Ironsand |
| HS1712525Black | ✓ | 17.00 | 1250 | 2500 | Black |

One side powdercoated, one side mill finish

| Product Code | Ex Stock | Thickness (mm) | Length (mm) | Width (mm) | Colour |
|--------------------|----------|----------------|-------------|------------|-------------|
| HS1461022MF | ✓ | 14.60 | 1000 | 2200 | Mill Finish |
| HS1461022Black | ✓ | 14.60 | 1000 | 2200 | Black |
| HS1461022Ironsand | ✓ | 14.60 | 1000 | 2200 | Ironsand |
| HS14610245MF | ✓ | 14.60 | 1000 | 2450 | Mill Finish |
| HS14610245Black | ✓ | 14.60 | 1000 | 2450 | Black |
| HS14610245Ironsand | ✓ | 14.60 | 1000 | 2450 | Ironsand |

"✓" Stocked Item
 "*" Pre-order Only Item
 (30-40 working days delivery)



Powder Coated Profiles Square Hollow

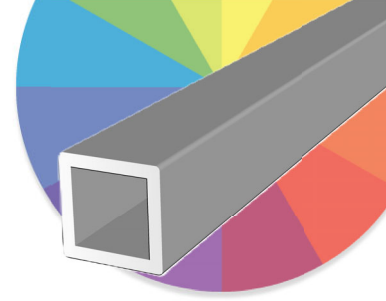

| Product Code | Ex Stock | A (mm) | T (mm) | R (mm) | Length (m) | Stocked Colours |
|--------------|----------|--------|--------|--------|------------|--|
| SHA19T1.2R2 | ✓ | 19.0 | 1.2 | 2.0 | 1.20 | Matt Appliance White |
| SHA19T1.2R2 | ✓ | 19.0 | 1.2 | 2.0 | 5.97 | Matt Black, Matt Appliance White |
| SHRA25T1.5R2 | ✓ | 25.0 | 1.5 | 2.0 | 5.97 | Matt Black, Matt Appliance White |
| SHRA40T2R3 | ✓ | 40.0 | 2.0 | 3.0 | 5.97 | Matt Black, Signal White, Dark Cedar, Antique Wood |
| SHRA50T2R3 | ✓ | 50.0 | 2.0 | 3.0 | 5.97 | Matt Black, Matt Ironsand, Matt Appliance White |
| SHRA50T3R3 | ✓ | 50.0 | 3.0 | 3.0 | 5.97 | Matt Black |
| SHRA65T2.5R3 | ✓ | 65.0 | 2.5 | 3.0 | 5.97 | Matt Black |
| SHRA75T3R3 | ✓ | 75.0 | 3.0 | 3.0 | 5.97 | Matt Black |
| SHA100T3 | ✓ | 100.0 | 3.0 | | 3.00 | Matt Black, Matt Ironsand |
| SHA100T3 | ✓ | 100.0 | 3.0 | | 5.97 | Matt Black, Matt Appliance White |
| SHRA100T3 | ✓ | 100.0 | 3.0 | 3.0 | 5.97 | Matt Black, Matt Appliance White |
| SHRA120T3 | ✓ | 120.0 | 3.0 | 3.0 | 5.97 | Matt Black, Matt Appliance White |

Powder Coated Profiles Square Hollow with Screw Holes

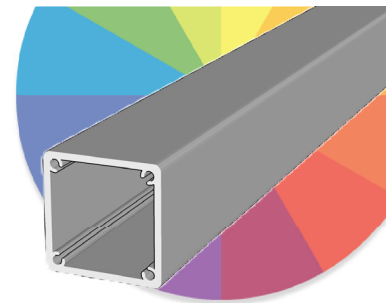

| Product Code | Ex Stock | A (mm) | T (mm) | R (mm) | Length (m) | Stocked Colours |
|--------------|----------|--------|--------|--------|------------|---|
| GM-NEWZ-50 | ✓ | 50.0 | 2.0 | 2.0 | 5.95 | Matt Black, Matt Appliance White, Matt Ironsand |
| GM-NEWZ-49 | ✓ | 65.0 | 2.0 | 2.0 | 5.95 | Matt Black, Matt Appliance White |
| GM-NEWZ-48 | ✓ | 75.0 | 2.5 | 3.0 | 5.95 | Matt Black, Matt Ironsand, Matt Appliance White |
| GM-NEWZ-47 | ✓ | 100.0 | 4.0 | | 5.95 | Matt Black, Matt Ironsand, Matt Appliance White, Signal White |

"✓" Stocked Item
 "✱" Pre-order Only Item
 (30-40 working days delivery)



Powder Coated Profiles Rectangular Hollow

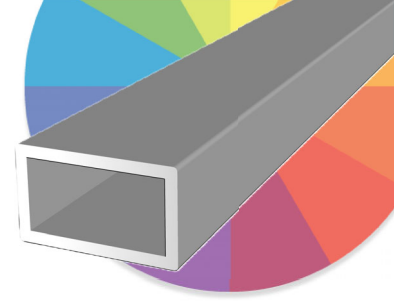

| Product Code | Ex Stock | A (mm) | B (mm) | T (mm) | R (mm) | Length (m) | Stocked Colours |
|---------------|----------|--------|--------|--------|--------|------------|---|
| GM-NEWZ-127 | ✓ | 38.0 | 25.0 | 1.2 | | 5.95 | Matt Black, Matt Ironsand |
| GM-NEWZ-61 | ✓ | 65.0 | 16.0 | 1.2 | 2.0 | 5.95 | Matt Black, Matt Appliance White |
| RHA75B40T2 | ✓ | 75.0 | 40.0 | 2.0 | | 5.95 | Matt Black |
| RHA80B50T3 | ✓ | 80.0 | 50.0 | 3.0 | | 5.95 | Matt Black, Matt Ironsand |
| RHRA80B50T3R3 | ✓ | 80.0 | 50.0 | 3.0 | 3.0 | 5.95 | Matt Black, Matt Ironsand, Matt Appliance White |
| GM-NEWZ-59 | ✓ | 100.0 | 19.7 | 1.4 | | 5.95 | Matt Black, Dark Cedar, Antique White |
| GM-NEWZ-60 | ✓ | 100.0 | 19.7 | 1.4 | | 5.95 | Matt Black, Dark Cedar, Matt Appliance White |
| RHA100B44T3 | ✓ | 100.0 | 44.0 | 3.0 | | 5.95 | Dark Cedar |
| RHA100B50T3 | ✓ | 100.0 | 50.0 | 3.0 | | 5.95 | Matt Black, Matt Ironsand |

Powder Coated Profiles Equal Angle

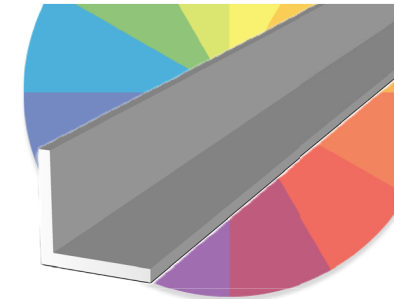

| Product Code | Ex Stock | A (mm) | T (mm) | Length (m) | Stocked Colours |
|--------------|----------|--------|--------|------------|---------------------------|
| EAA12T1.6 | ✓ | 12.0 | 1.6 | 3.00 | Matt Black, Signal White |
| EAA20T1.6 | ✓ | 20.0 | 1.6 | 3.00 | Matt Black, Signal White |
| EAA25T1.6 | ✓ | 25.0 | 1.5 | 3.00 | Matt Black, Signal White |
| EAA25T2.5 | ✓ | 25.0 | 2.5 | 5.95 | Matt Black, Matt Ironsand |
| EAA30T1.5 | ✓ | 30.0 | 1.5 | 3.00 | Matt Black, Signal White |
| EAA30T3 | ✓ | 30.0 | 3.0 | 5.95 | Matt Black, Matt Ironsand |
| EAA40T1.6 | ✓ | 40.0 | 1.6 | 3.00 | Matt Black, Signal White |
| EAA50T1.6 | ✓ | 50.0 | 1.6 | 3.00 | Matt Black |
| EAA50T3 | ✓ | 50.0 | 3.0 | 5.95 | Matt Black, Matt Ironsand |
| EAA50T6 | ✓ | 50.0 | 6.0 | 5.95 | Matt Black, Matt Ironsand |

"✓" Stocked Item
 "✱" Pre-order Only Item
 (30-40 working days delivery)



Powder Coated Profiles Round Tube



| Product Code | Ex Stock | D (mm) | T (mm) | Length (m) | Stocked Colours |
|--------------|----------|--------|--------|------------|--|
| RTD19T1.2 | ✓ | 19.0 | 1.2 | 5.95 | Matt Black, Matt Appliance White |
| RTD19T1.6 | ✓ | 19.0 | 1.6 | 5.95 | Matt Black, Matt Appliance White |
| RTD40T0.9 | ✓ | 40.0 | 0.9 | 5.95 | Matt Black, Matt Ironsand, Signal White, Matt Charcoal |

Powder Coated Profiles Flat Bar

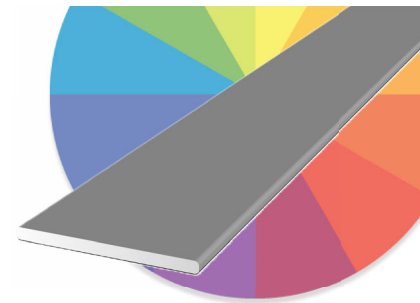

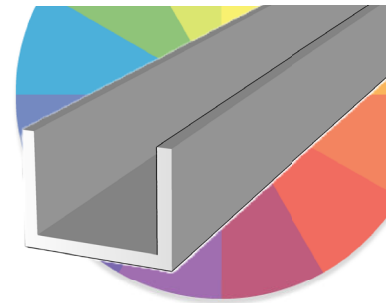

| Product Code | Ex Stock | A (mm) | T (mm) | Length (m) | Stocked Colours |
|--------------|----------|--------|--------|------------|---|
| FBA25T3 | ✓ | 25.0 | 3.0 | 5.97 | Matt Black, Signal White |
| FBA50T3 | ✓ | 50.0 | 3.0 | 5.97 | Matt Black |
| FBA50T10 | ✓ | 50.0 | 10.0 | 5.97 | Matt Black, Matt Ironsand |
| FBA70T10 | ✓ | 70.0 | 10.0 | 6.00 | Matt Black |
| FBA90T6 | ✓ | 90.0 | 6.0 | 5.40 | Matt Black, Matt Appliance, Matt Ironsand, Dark Cedar |

Powder Coated Profiles Channel

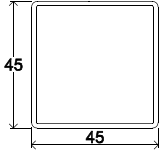
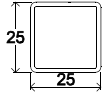
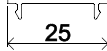
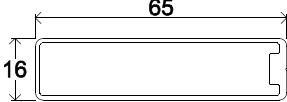
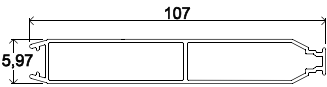
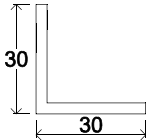
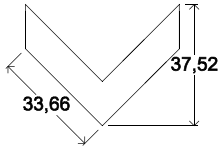
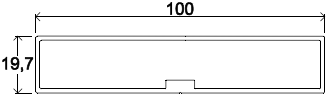
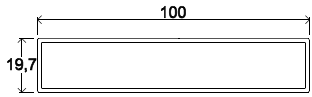
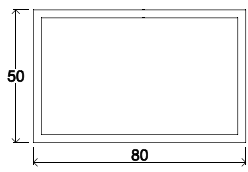
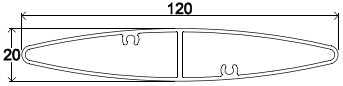
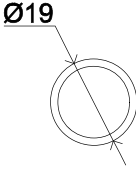
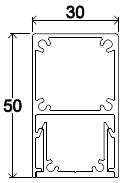
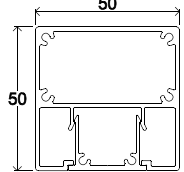
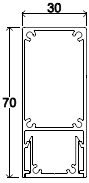
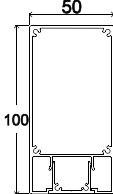

| Product Code | Ex Stock | A (mm) | B (mm) | T (mm) | Length (m) | Stocked Colours |
|--------------|----------|--------|--------|--------|------------|---------------------------|
| CLA50B15T3 | ✓ | 50.0 | 15.0 | 3.0 | 5.97 | Matt Black, Matt Ironsand |
| CLA50B50T3 | ✓ | 50.0 | 50.0 | 3.0 | 5.95 | Matt Black, Matt Ironsand |
| CLA58B65T3.5 | ✓ | 58.0 | 65.0 | 3.5 | 5.95 | Matt Black, Matt Ironsand |

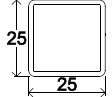
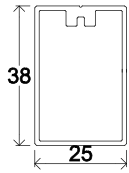
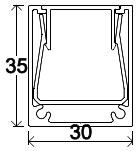
| | | | | | | | |
|---|----------------|---|------------------|--|---------------|---|------------------|
|  | |  | |  | |  | |
| Product Code | SHS45T1.6Punch | Product Code | SHARA25T1.5R2L2 | Product Code | GM-NEWZ-139 | Product Code | GM-NEWZ-61 |
| Weight (Kg/m) | 0.783 | Weight (Kg/m) | 0.393 | Weight (Kg/m) | 0.103 | Weight (Kg/m) | 0.617 |
|  | |  | |  | |  | |
| Product Code | GM-NEWZ-05 | Product Code | 30x30x3JL | Product Code | SL-77 | Product Code | GM-NEWZ-60 |
| Weight (Kg/m) | 0.896 | Weight (Kg/m) | 0.487 | Weight (Kg/m) | | Weight (Kg/m) | 1.021 |
|  | |  | |  | |  | |
| Product Code | GM-NEWZ-59 | Product Code | WZ-80x50x3RPunch | Product Code | GM-NEWZ-06 | Product Code | D19x1.6 |
| Weight (Kg/m) | 0.932 | Weight (Kg/m) | 2.120 | Weight (Kg/m) | 1.087 | Weight (Kg/m) | 0.103 |
|  | |  | |  | |  | |
| Product Code | GM-NEWZ-51&53 | Product Code | GM-NEWZ-54&53 | Product Code | GM-NEWZ-52&53 | Product Code | GM-NEWZ-55&53 |
| Weight (Kg/m) | 1.037 | Weight (Kg/m) | 1.447 | Weight (Kg/m) | 0.984 | Weight (Kg/m) | 1.872 |
|  | |  | |  | |  | |
| Product Code | 19x19x1.2R | Product Code | 25x25x1.5R | Product Code | GM-NEWZ-127 | Product Code | GM-NEWZ-56-57-58 |
| Weight (Kg/m) | 0.235 | Weight (Kg/m) | 0.393 | Weight (Kg/m) | 0.497 | Weight (Kg/m) | 0.808 |

Fence System Profiles

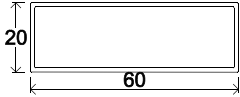
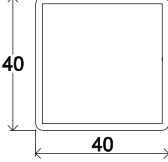
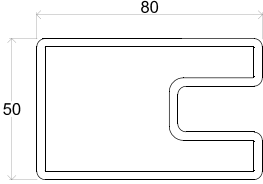
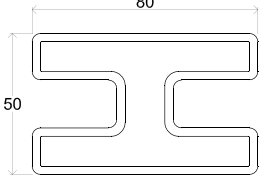



| | | | | | | | |
|---|--------|---|-----------------|--|-------------|---|-------------|
|  | |  | |  | |  | |
| Product Code | DLX-10 | Product Code | GM-NEWZ-40x40x2 | Product Code | GM-NEWZ-153 | Product Code | GM-NEWZ-186 |
| Weight (Kg/m) | 0.531 | Weight (Kg/m) | 0.857 | Weight (Kg/m) | 2.530 | Weight (Kg/m) | 3.060 |



| | | | | | | | |
|---|------------------------------|---|------------------------------|--|------------------------------|---|------------------------------|
|  | |  | |  | |  | |
| Product Code | SL-30 | Product Code | SL-31 | Product Code | SL-74 | Product Code | SL-138 |
| Description | Fence Bracket for 38x25 Rail | Description | Fence Bracket for 40x40 Rail | Description | Fence Bracket for 45x45 Rail | Description | Fence Bracket for 50x50 Rail |
|  | |  | |  | |  | |
| SL-150 For 38x25 Rail | | SL-197 For 25x38 Rail | | | | For 50x50mm Post Stocked in Matt Black, Matt Appliance White | |
| Product Code | | Product Code | SL-151 | Product Code | SL-154 | Product Code | SL-89 |
| Description | Fence Bracket for 38x25 Rail | Description | Fence Bracket for 40x40 Rail | Description | Fence Bracket for 50x25 Rail | Description | Post Flange Plate |
|  | |  | |  | |  | |
| For 65x65mm Post Stocked in Matt Black, Matt Appliance White | | For 75x75mm Post Stocked in Matt Black, Matt Appliance White | | For 100x100mm Post Stocked in Matt Black, Matt Appliance White | | For 50x50mm Post Stocked in Matt Black, Silver | |
| Product Code | SL-90 | Product Code | SL-91 | Product Code | SL-92 | Product Code | SL-25 |
| Description | Post Flange Plate | Description | Post Flange Plate | Description | Post Flange Plate | Description | 50mm Aluminium Post Cap |
|  | |  | |  | |  | |
| For 50x50mm Post Stocked in Matt Black, Matt Appliance White, Silver | | For 65x65mm Post Stocked in Matt Black, Matt Appliance White, Silver | | For 75x75mm Post Stocked in Matt Black, Matt Appliance White, Silver | | For 100x100mm Post Stocked in Matt Black, Matt Appliance White, Silver | |
| Product Code | SL-41 | Product Code | SL-40 | Product Code | SL-39 | Product Code | SL-38 |
| Description | Square Metal Post Cap | Description | Square Metal Post Cap | Description | Square Metal Post Cap | Description | Square Metal Post Cap |
|  | |  | |  | |  | |
| For D50mm Post Stocked in Silver | | For D65mm Post Stocked in Silver | | For D75mm Post Stocked in Silver | | For D100mm Post Stocked in Silver | |
| Product Code | SL-37 | Product Code | SL-36 | Product Code | SL-35 | Product Code | SL-34 |
| Description | Round Metal Post Cap | Description | Round Metal Post Cap | Description | Round Metal Post Cap | Description | Round Metal Post Cap |

| | | | | | | | |
|---|--------------------------------|---|--------------------------------|--|--------------------------------|---|--------------------------------|
|  | |  | |  | |  | |
| <i>For D16x1.6 Round Tube</i> | | <i>For D19x1.6 Round Tube</i> | | <i>For D40x2.0 Round Tube</i> | | <i>For D50x2.0 Round Tube</i> | |
| Product Code | SL-99 | Product Code | SL-89 | Product Code | SL-59 | Product Code | SL-60 |
| Description | Round Plastic Picket Cap | Description | Round Plastic Picket Cap | Description | Round Plastic Picket Cap | Description | Round Plastic Picket Cap |
|  | |  | |  | |  | |
| <i>For D60x2.0 Round Tube</i> | | <i>For 19x19mm Square Tube</i> | | <i>For 25x25mm Square Tube</i> | | <i>For 40x40mm Square Tube</i> | |
| Product Code | SL-61 | Product Code | SL-104 | Product Code | SL-173 | Product Code | SL-176 |
| Description | Round Plastic Picket Cap | Description | Square Plastic Picket Cap | Description | Square Plastic Picket Cap | Description | Square Plastic Picket Cap |
|  | |  | |  | |  | |
| <i>For 40x40mm Square Tube</i> | | <i>For 50x50mm Square Tube</i> | | <i>For 63.5x63.5mm Square Tube</i> | | <i>For 65x65mm Square Tube</i> | |
| Product Code | SL-151 | Product Code | SL-54 | Product Code | SL-55 | Product Code | SL-253 |
| Description | Square Plastic Picket Cap | Description | Square Plastic Picket Cap | Description | Square Plastic Picket Cap | Description | Square Plastic Picket Cap |
|  | |  | |  | |  | |
| <i>For 75x75mm Square Tube</i> | | <i>For NEWZ-127 Picket Or 38x25mm Rectangular Picket</i> | | <i>For 38x25mm Rectangular Tube</i> | | <i>For 50x25mm Square Tube</i> | |
| Product Code | SL-56 | Product Code | SL-161 | Product Code | SL-150 | Product Code | SL-175 |
| Description | Square Plastic Picket Cap | Description | Rectangular Plastic Picket Cap | Description | Rectangular Plastic Picket Cap | Description | Rectangular Plastic Picket Cap |
|  | |  | |  | |  | |
| <i>For 80x50mm Rectangular Tube</i> | | <i>For 100x50mm Rectangular Tube</i> | | <i>For 65x16mm Rectangular Tube</i> | | <i>For 100x19.7mm Rectangular Tube</i> | |
| Product Code | SL-57 | Product Code | SL-58 | Product Code | SL-22 | Product Code | SL-12 |
| Description | Rectangular Plastic Picket Cap | Description | Rectangular Plastic Picket Cap | Description | Rectangular Plastic Picket Cap | Description | Rectangular Plastic Picket Cap |

Fence System Accessories

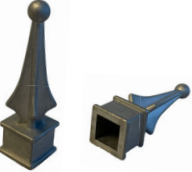
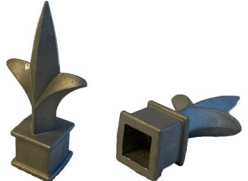
| | | | | | | | |
|---|------------------|---|-------------------|--|-----------------------|--|-------------------|
|  | |  | |  | |  Spear Head for D19 Round Tube | |
| Product Code | SL-170 | Product Code | SL-171 | Product Code | SL-169 | Product Code | SL-64 |
| Weight (Kg/m) | Hydraulic Hinge | Weight (Kg/m) | Standard Hinge | Weight (Kg/m) | Pedestrian Gate Latch | Weight (Kg/m) | Round Spear Head |
|  | |  | |  | |  | |
| Spear Head for D16 Round Tube | | Spear Head for 16x16 SHS | | Spear Head for 19x19 SHS | | Spear Head for 16x16 SHS | |
| Product Code | SL-63 | Product Code | SL-65 | Product Code | SL-67 | Product Code | SL-66 |
| Weight (Kg/m) | Round Spear Head | Weight (Kg/m) | Square Spear Head | Weight (Kg/m) | Square Spear Head | Weight (Kg/m) | Square Spear Head |

Fence Hardwares

| | | | | | | | | | |
|---|---------------------------|---|---------------------------|---|------------------------------|---|------------------------------|---|--------------------------------|
|  | |  | |  | |  | |  | |
| Product Code | SHG-90 / SHG-90L | Product Code | SHF-90L / SHF-90L-1 | Product Code | SHN-90L / SHN-90L-1 | Product Code | SHH-135LS / SHH-135S | Product Code | SHC-135 |
| Weight (Kg/m) | Adjustable Tension Hinge | Weight (Kg/m) | Fixed Tension Hinge | Weight (Kg/m) | Neutral Tension Hinge | Weight (Kg/m) | Heavy Duty Tension Hinge | Weight (Kg/m) | Self-adjustable Coilkilk Hinge |
|  | |  | |  | |  | |  | |
| Product Code | SLV-VIPER X1 / X1-IK | Product Code | SLV-VIPER X2 / X2-IK | Product Code | SL-25H | Product Code | SL-50H | Product Code | SL-50K |
| Weight (Kg/m) | Single Side Gravity Latch | Weight (Kg/m) | Double Side Gravity Latch | Weight (Kg/m) | Top Pull Magnetic Gate Latch | Weight (Kg/m) | Top Pull Magnetic Gate Latch | Weight (Kg/m) | Top Pull Magnetic Latch |
|  <i>Top Pull Lockable Trilatch - Child Safety Design Magnetic Falto Latch</i> | |  | |  | |  | | | |
| Product Code | SL-50TRI | Product Code | SHN-90L / SHN-90L-1 | Product Code | SGSS | Product Code | SGSL | | |
| Weight (Kg/m) | Top Pull Magnetic Latch | Weight (Kg/m) | Neutral Tension Hinge | Weight (Kg/m) | Small Size Gate Stop | Weight (Kg/m) | Large Size Gate Stop | | |

Pre-Punched Extrusions

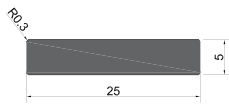
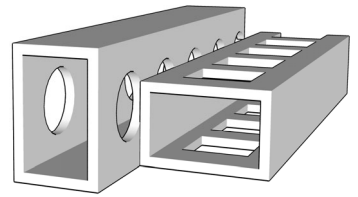

GM-NEWZ-25x5LB
Ø6.3mm Round Hole
Weight: 0.356kg/m

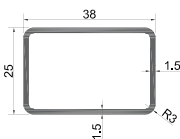
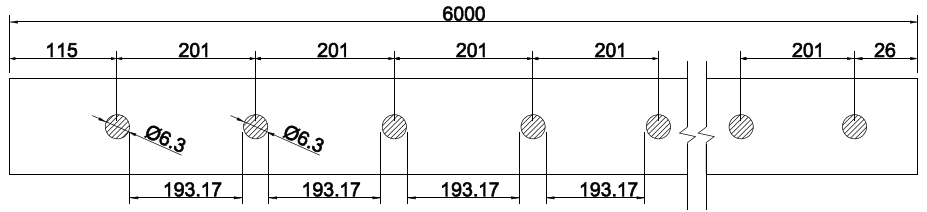
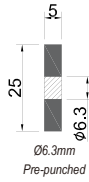

GM-NEWZ-38x25x1.5R
Ø20mm Round Hole
Weight: 0.523kg/m

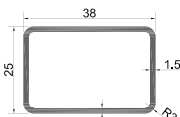
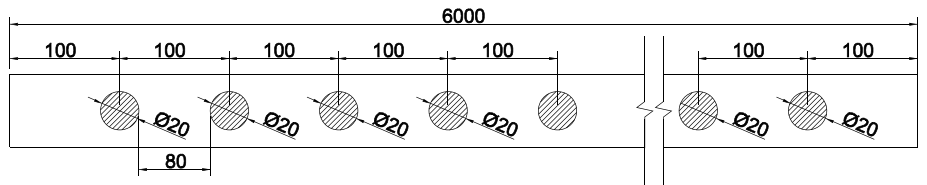
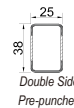
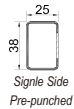

GM-NEWZ-38x25x1.5R
20mm Square Hole
Weight: 0.523kg/m

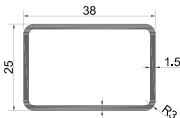
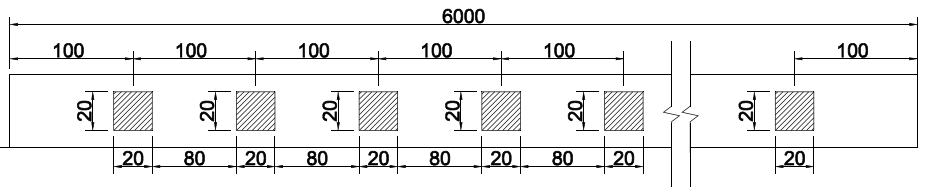
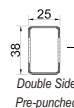
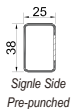

GM-NEWZ-38x25x1.5R
Ø20mm Round Hole
Weight: 0.500kg/m

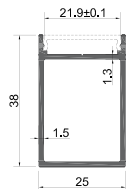
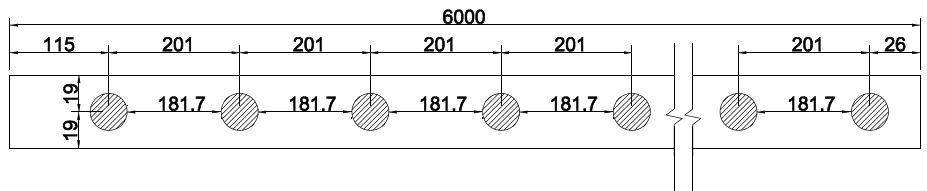
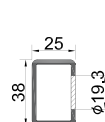

GM-NEWZ-68
20mm Square Hole
Weight: 0.50kg/m

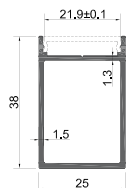
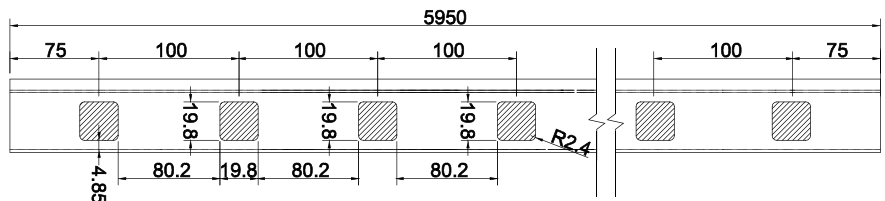
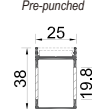
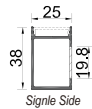

GM-NEWZ-68
Ø20mm Round Hole
Weight: 0.50kg/m

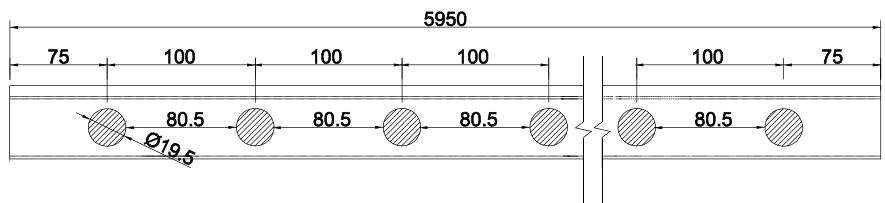
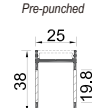
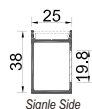

Pre-Punched Extrusions

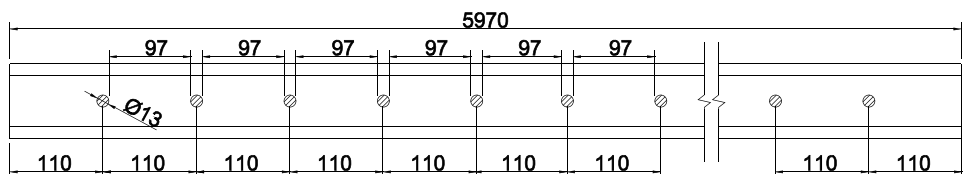
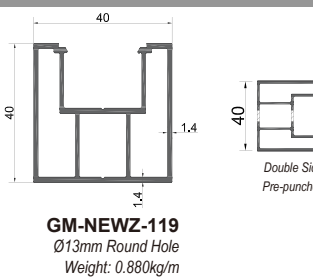
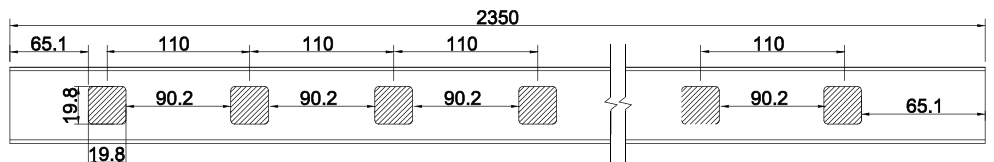
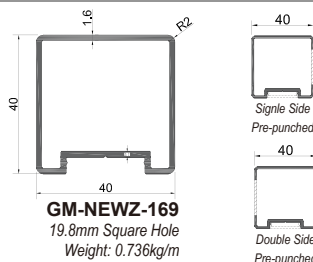
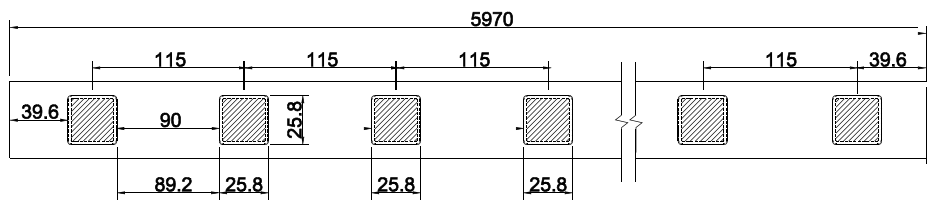
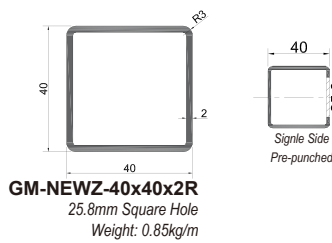
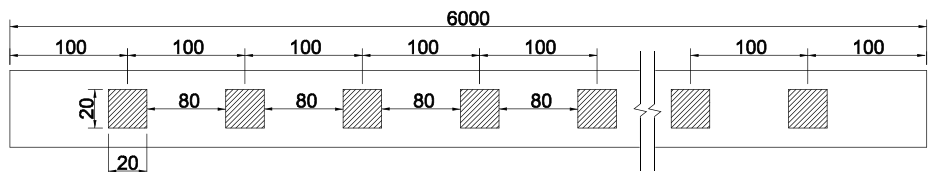
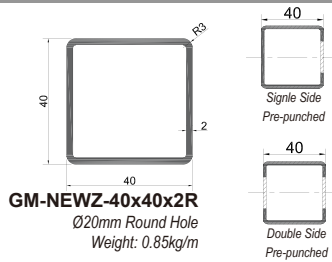
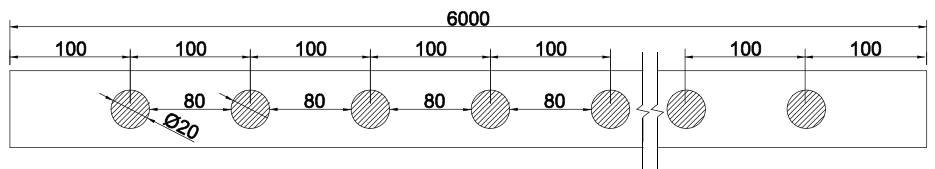
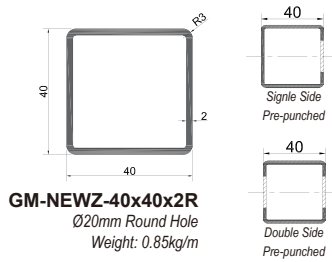
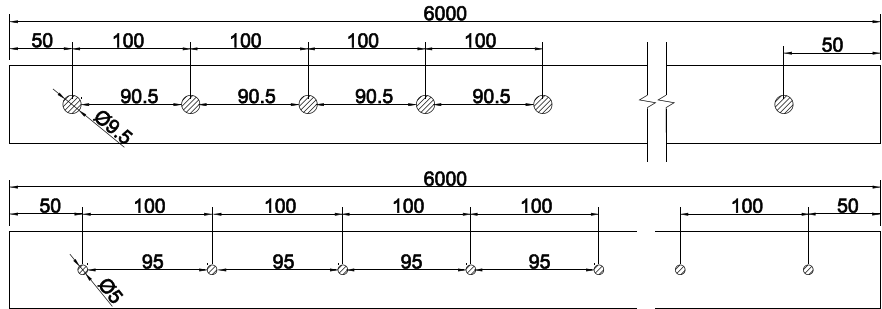
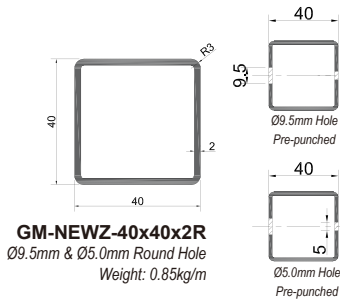
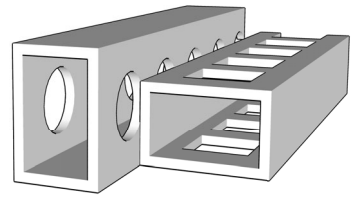

Pre-Punched Extrusions

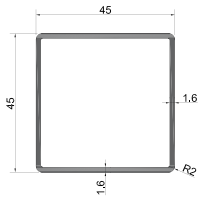
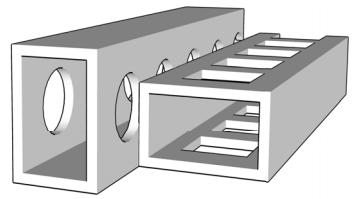

GM-NEWZ-45x45x1.6R
25.6mm Square Hole
Weight: 0.783kg/m

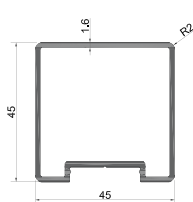
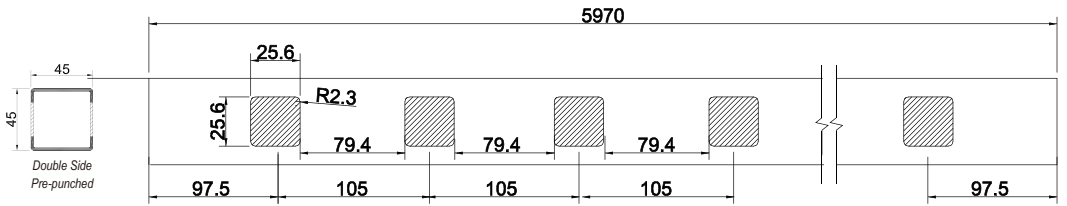

GM-NEWZ-167
25.8mm Square Hole
Weight: 0.830kg/m

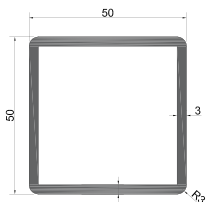
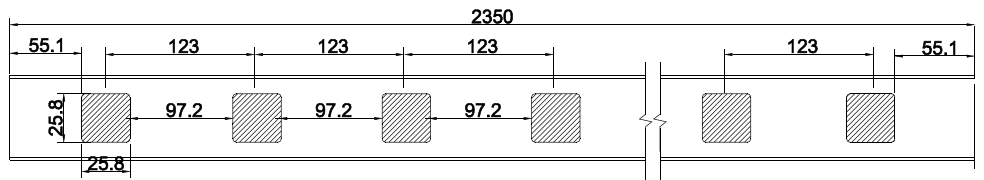

GM-NEWZ-50x50x3R
Ø20mm Round Hole
Weight: 1.67kg/m

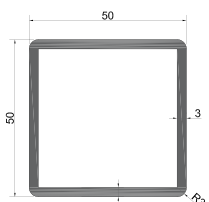
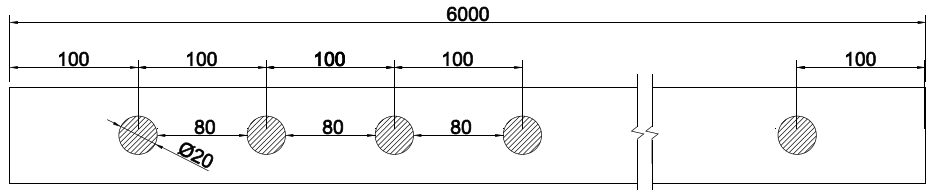
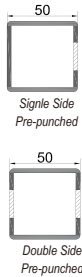

GM-NEWZ-50x50x3R
20mm Square Hole
Weight: 1.585kg/m

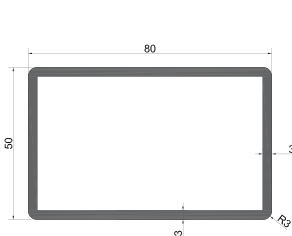
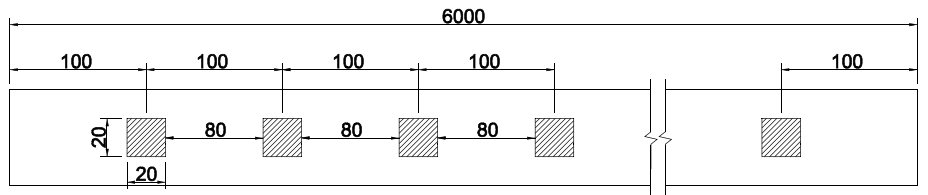
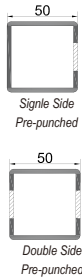

WZ-80x50x3R
Ø20mm Round Hole
Weight: 2.21kg/m

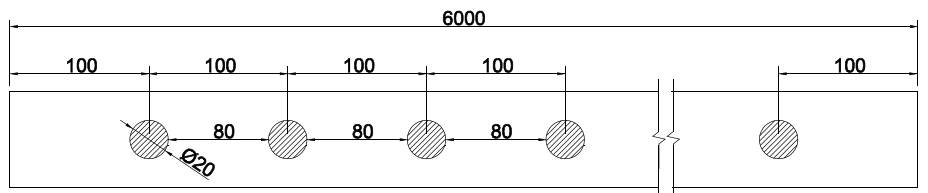
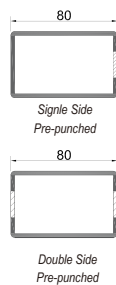

Pre-Punched Extrusions

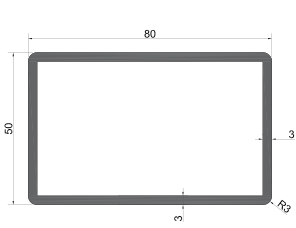
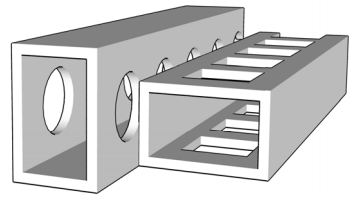

WZ-80x50x3R
20mm Square Hole
Weight: 2.21kg/m

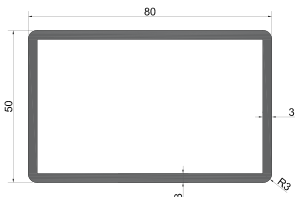
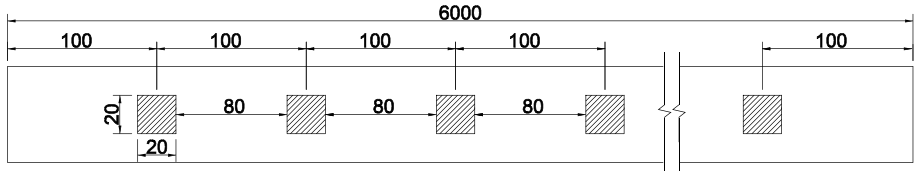
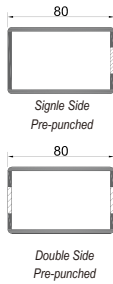

WZ-80x50x3R
25.8mm Square Hole
Weight: 2.100kg/m

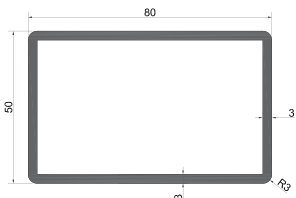
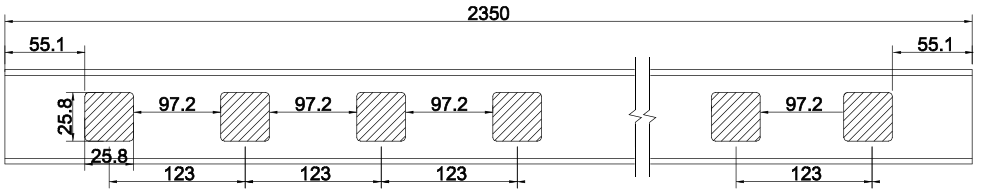
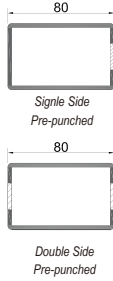

WZ-80x50x3R
25.8mm Square Hole
Weight: 2.100kg/m

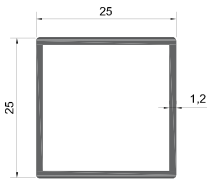
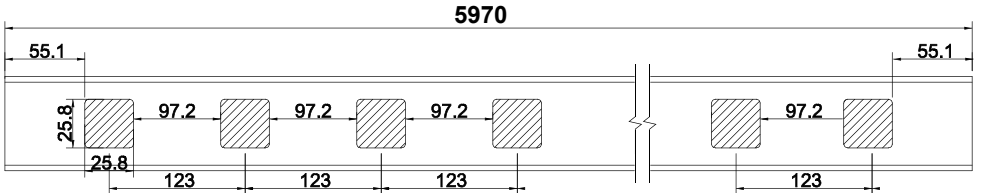
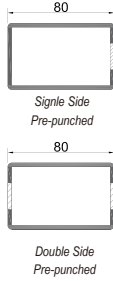

SHARA25T1.2R
25x25x1.2R2L2.1mm Square Hollow

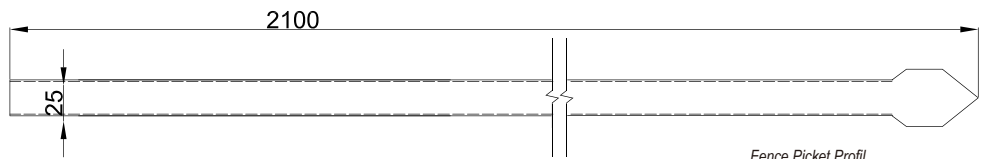

Fence Picket Profil
Fit WZ-80x50x3R Punched

Pre-Punched Extrusions

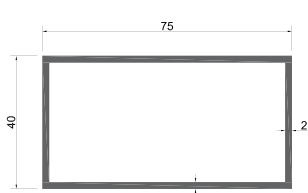
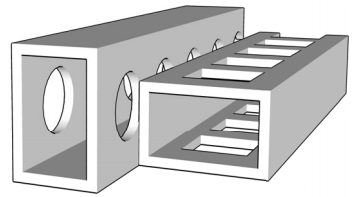

GM-NEWZ-75x40x2
GM-NEWZ-06 Hole
Weight: 1.265kg/m

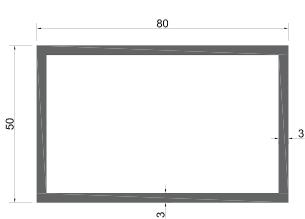
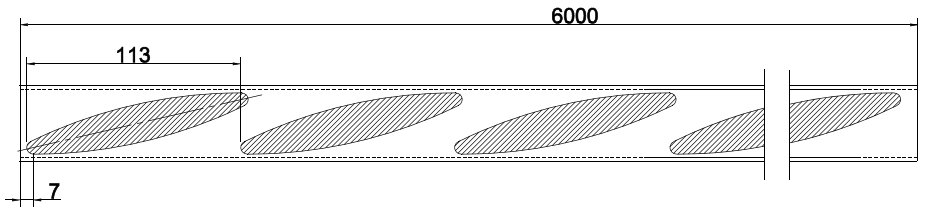
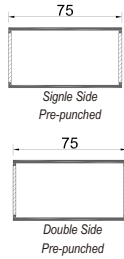

GM-NEWZ-80x50x3
GM-NEWZ-06 Hole
Weight: 2.33kg/m

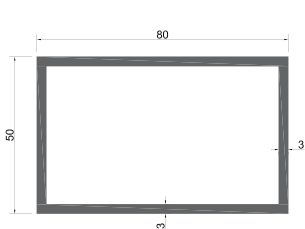
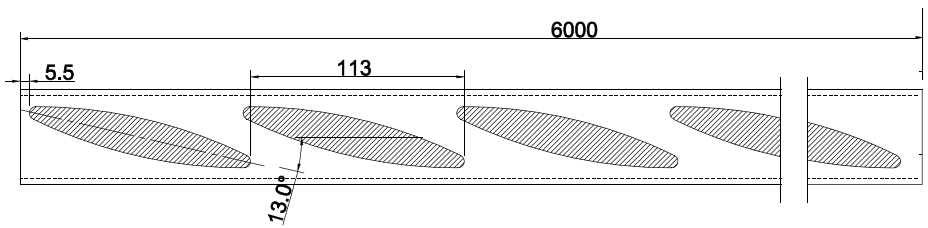
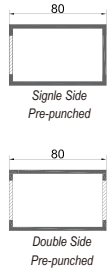

GM-NEWZ-80x50x3
GM-NEWZ-06 Hole
Weight: 2.12kg/m

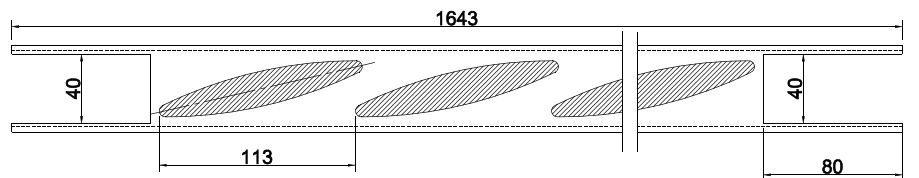
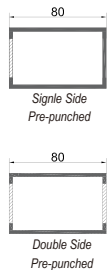

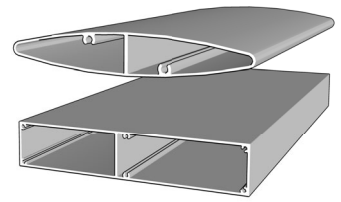

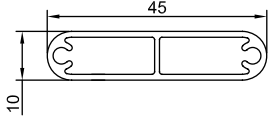
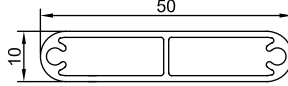
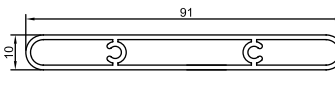
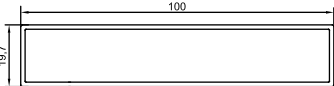
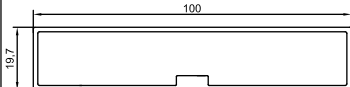
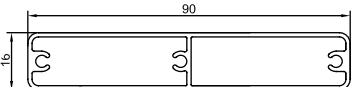
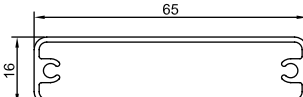
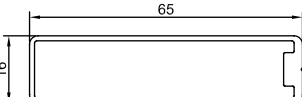
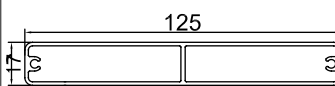
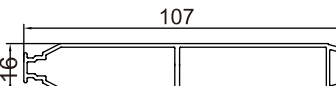
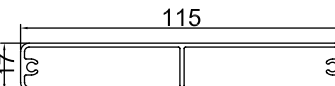
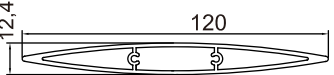
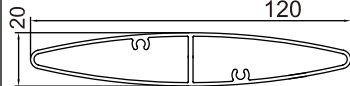
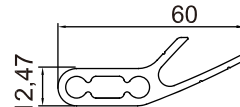
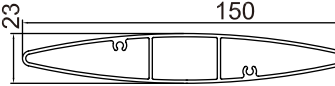
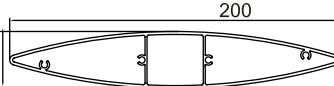
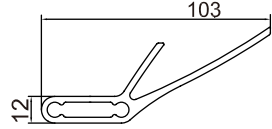
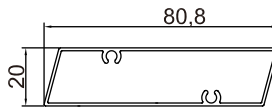
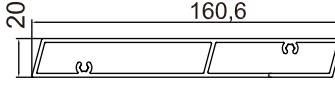
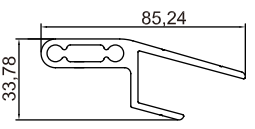
| | | | | | | | |
|---|-------------|---|-------------|--|-------------|---|-------------|
|  | |  | |  | |  | |
| Product Code | GM-NEWZ-95 | Product Code | GM-NEWZ-96 | Product Code | GM-NEWZ-07 | Product Code | GM-NEWZ-59 |
| Weight (Kg/m) | 0.410 | Weight (Kg/m) | 0.420 | Weight (Kg/m) | 0.880 | Weight (Kg/m) | 0.880 |
|  | |  | |  | |  | |
| Product Code | GM-NEWZ-60 | Product Code | GM-NEWZ-09 | Product Code | GM-NEWZ-04 | Product Code | GM-NEWZ-61 |
| Weight (Kg/m) | 0.930 | Weight (Kg/m) | 0.860 | Weight (Kg/m) | 0.650 | Weight (Kg/m) | 0.690 |
|  | |  | |  | |  | |
| Product Code | GM-NEWZ-94 | Product Code | GM-NEWZ-05 | Product Code | GM-NEWZ-93 | Product Code | GM-NEWZ-65 |
| Weight (Kg/m) | 1.250 | Weight (Kg/m) | 1.100 | Weight (Kg/m) | 1.160 | Weight (Kg/m) | 1.170 |
|  | |  | |  | |  | |
| Product Code | GM-NEWZ-06 | Product Code | GM-NEWZ-71 | Product Code | GM-NEWZ-70 | Product Code | GM-NEWZ-102 |
| Weight (Kg/m) | 1.090 | Weight (Kg/m) | 1.080 | Weight (Kg/m) | 1.340 | Weight (Kg/m) | 1.053 |
|  | |  | |  | |  | |
| Product Code | GM-NEWZ-130 | Product Code | GM-NEWZ-142 | Product Code | GM-NEWZ-143 | Product Code | GM-NEWZ-144 |
| Weight (Kg/m) | 0.510 | Weight (Kg/m) | 0.610 | Weight (Kg/m) | 2.210 | Weight (Kg/m) | 1.450 |

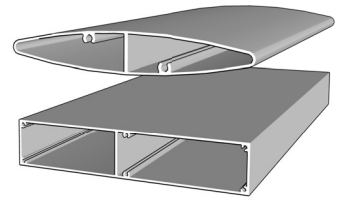

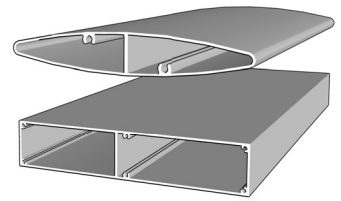

| | | | | | | | |
|---------------|---------------------|---------------|----------------------|---------------|-----------------|---------------|-----------------|
| | | | | | | | |
| Product Code | CLSA50B50T3 | Product Code | GM-NEWZ-56 & 57 & 58 | Product Code | GM-NEWZ-51 & 53 | Product Code | GM-NEWZ-52 & 53 |
| Weight (Kg/m) | 1.219 | Weight (Kg/m) | 0.770 | Weight (Kg/m) | 1.070 | Weight (Kg/m) | 1.220 |
| | | | | | | | |
| Product Code | GM-NEWZ-54 & 53 | Product Code | GM-NEWZ-55 & 53 | Product Code | GM-NEWZ-97 | Product Code | NEWZ120 |
| Weight (Kg/m) | 1.480 | Weight (Kg/m) | 1.910 | Weight (Kg/m) | 1.680 | Weight (Kg/m) | 1.910 |
| | | | | | | | |
| Product Code | GM-NEWZ-98 | Product Code | GM-NEWZ-101 | Product Code | GM-NEWZ-100 | Product Code | GM-NEWZ-131 |
| Weight (Kg/m) | 2.480 | Weight (Kg/m) | 3.460 | Weight (Kg/m) | 4.840 | Weight (Kg/m) | 5.750 |
| | | | | | | | |
| Product Code | RHA200B75T3 | Product Code | GM-NEWZ-181 | Product Code | GM-NEWZ-182 | Product Code | GM-NEWZ-183 |
| Weight (Kg/m) | 4.600 | Weight (Kg/m) | 1.210 | Weight (Kg/m) | 1.770 | Weight (Kg/m) | 0.05 |
| | | | | | | | |
| Product Code | GM-NEWZ-181 End Cap | Product Code | GM-NEWZ-182 End Cap | Product Code | GM-NEWZ-184 | Product Code | SHA50T2.0 |
| Weight (Kg/m) | 0.011 | Weight (Kg/m) | 0.018 | Weight (Kg/m) | 4.690 | Weight (Kg/m) | 1.094 |



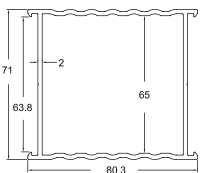
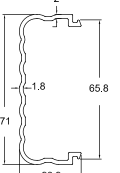
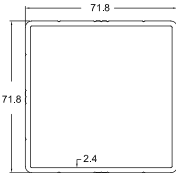
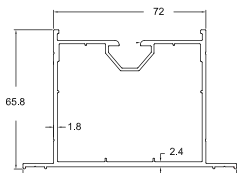
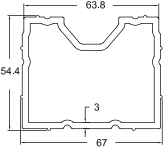
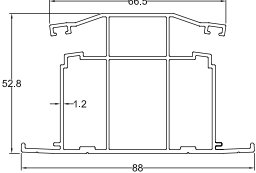
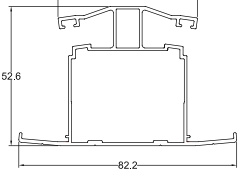
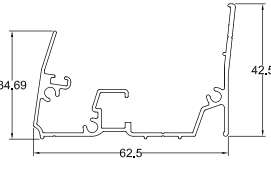
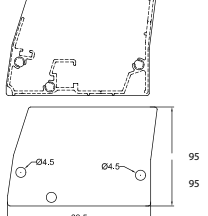
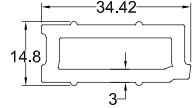
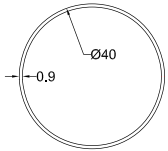
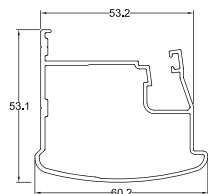
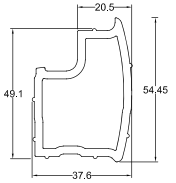
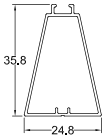
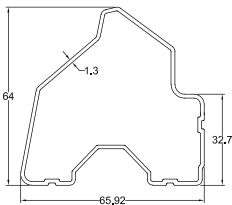
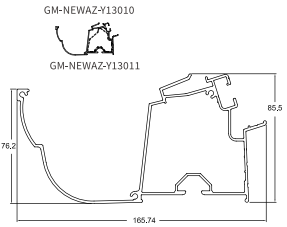
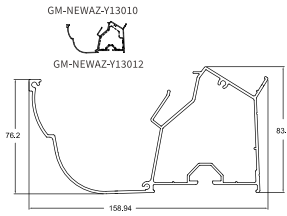
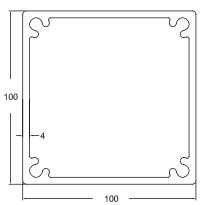
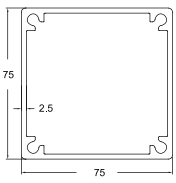
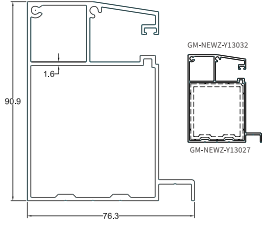



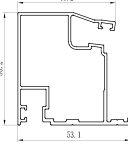
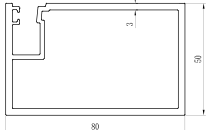
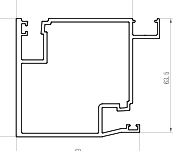
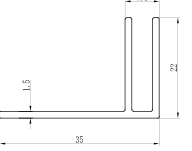
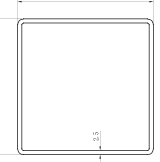
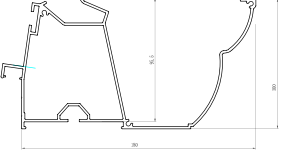
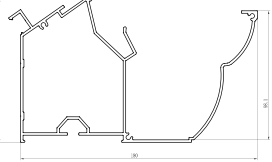
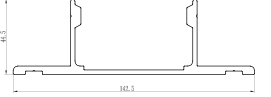
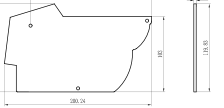
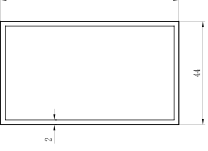
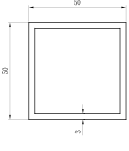
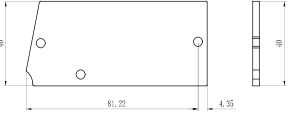
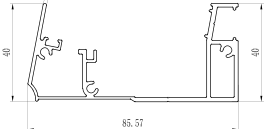
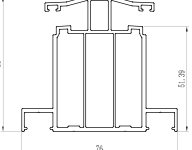
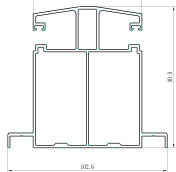
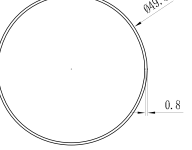





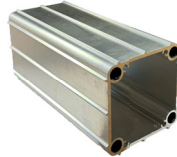

| | | | | | | | |
|---|---------------|---|---------------|--|-------------|--|--------------------|
| | | | | | | <p>For 40x40x2 SHS 50x40x3 RHS 60x40x3 RHS 75x40x3 RHS 80x40x3 RHS</p> | |
| Product Code | RHA125B30T2.5 | Product Code | RHA150B30T2.5 | Product Code | RHA80B50T3 | Product Code | GM-KPM-122 |
| Weight (Kg/m) | 2.138 | Weight (Kg/m) | 2.494 | Weight (Kg/m) | 2.120 | Weight (Kg/m) | 2.640 |
| <p>For 300x50x2.0 RHS 250x50x2.0 RHS 200x50x2.0 RHS 150x50x2.0 RHS 100x50x2.0 RHS 80x50x2.0 RHS</p> | | <p>For 300x50x2.5 RHS 250x50x2.5 RHS 200x50x2.5 RHS 150x50x2.5 RHS 100x50x2.5 RHS 80x50x2.5 RHS</p> | | <p>For 80x50x3 RHS</p> | | <p>For 38x25x2 RHS 25x25x2.5 RHS 40x25x2.5 RHS 50x25x2.5 RHS 60x25x2.5 RHS 100x25x2.5 RHS 120x25x2.5 RHS 150x25x2.5 RHS 200x25x2.5 RHS 250x25x2.5 RHS 300x25x2.5 RHS</p> | |
| Product Code | GM-NEWZ-133 | Product Code | GM-NEWZ-134 | Product Code | GM-NEWZ-123 | Product Code | GM-NEWZ-121 |
| Weight (Kg/m) | 2.673 | Weight (Kg/m) | 2.686 | Weight (Kg/m) | 5.570 | Weight (Kg/m) | 1.730 |
| | | <p>For 50x50x3 SHS 65x40x2 RHS 60x40x2 RHS 75x40x2 RHS 80x40x2 RHS</p> | | <p>For GM-NEWZ-98 GM-NEWZ-97 GM-NEWZ-120 GM-NEWZ-101 GM-NEWZ-100</p> | | | |
| Product Code | GM-NEWZ-145 | Product Code | GM-KPM-5511 | Product Code | SL-149 | Product Code | GM-NEWZ-58x65x3.5U |
| Weight (Kg/m) | 4.480 | Weight (Kg/m) | 5.970 | Weight (Kg/m) | 3.000 | Weight (Kg/m) | 1.870 |
| | | | | | | | |
| Product Code | Louvre Roller | Product Code | SL-157 | Product Code | SL-155 | Product Code | SL-156 |
| Weight (Kg/m) | | Weight (Kg/m) | 2.290 | Weight (Kg/m) | 6.130 | Weight (Kg/m) | 3.240 |
| | | | | | | | |
| Product Code | GM-NEWZ-135 | | | | | | |
| Weight (Kg/m) | 0.720 | | | | | | |

| | | | | | | | |
|---|-----------------------------|---|-----------------------------------|--|-------------------------|---|------------------------|
|  | |  | |  | |  | |
| Product Code | GM-NEWZ-Y13001 | Product Code | GM-NEWZ-Y13002 | Product Code | GM-NEWZ-Y13026 | Product Code | GM-NEWZ-Y13003 |
| Description | Pillar | Description | Pillar Cap | Description | Pillar - New Style | Description | Top Beam |
|  | |  | |  | |  | |
| Product Code | GM-NEWZ-Y13023 | Product Code | GM-NEWZ-Y13005 | Product Code | GM-NEWZ-Y13006 | Product Code | GM-NEWZ-Y13007 |
| Description | Flat Top Extended Ferrule | Description | Premium Frame | Description | Standard Frame | Description | Wall Edge |
|  | |  | |  | |  | |
| Product Code | GM-NEWZ-95x3.5 | Product Code | GM-NEWZ-Y13022 | Product Code | GM-NEWZ-D40x0.9 | Product Code | GM-NEWZ-Y13008 |
| Description | Wall Edge End Cap | Description | Strengthen Frame Extended Ferrule | Description | Water Pipe | Description | Side Frame |
|  | |  | |  | |  | |
| Product Code | GM-NEWZ-Y13024 | Product Code | GM-NEWZ-Y13009 | Product Code | GM-NEWZ-Y13010 | Product Code | GM-NEWZ-Y13011 |
| Description | Side Frame Extended Ferrule | Description | Support Bar | Description | Gutter Extended Ferrule | Description | Straight Edge Gutter |
|  | |  | |  | |  | |
| Product Code | GM-NEWZ-Y13012 | Product Code | GM-NEWZ-47 | Product Code | GM-NEWZ-48 | Product Code | GM-NEWZ-Y13032 |
| Description | Radius Edge Gutter | Description | 100mm Strengthen Pillar | Description | 75mm Strengthen Pillar | Description | Strengthen Side Girder |

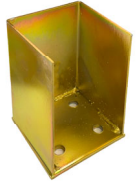
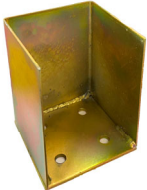
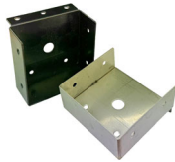

| | | | | | | | |
|--------------|----------------------------|--------------|--------------------------|--------------|------------------------|--------------|------------------------|
| | | | | | | | |
| Product Code | GM-NEWZ-Y13028 | Product Code | GM-NEWZ-Y13027 | Product Code | GM-NEWZ-Y13030 | Product Code | GM-NEWZ-Y13029 |
| Description | Strengthen Girder | Description | Girder Ferrule | Description | Strengthen Girder Cap | Description | Strengthen Girder Seat |
| | | | | | | | |
| Product Code | GM-NEWZ-Y13031 | Product Code | SL-85 | Product Code | GM-NEWZ-Y13033 | Product Code | GM-NEWZ-Y13034 |
| Description | Reinforce Fixed Wall Eaves | Description | Wall Eaves End Cap | Description | Strengthen Support Bar | Description | Strengthen Sink Front |
| | | | | | | | |
| Product Code | GM-NEWZ-Y13035 | Product Code | GM-NEWZ-Y13037 | Product Code | GM-JL-70 | Product Code | GM-NEWZ-Y13036 |
| Description | Strengthen Gutter | Description | Front Gutter Ferrule | Description | Gutter End Cap | Description | Bottom Jointer |
| | | | | | | | |
| Product Code | GM-NEWZ-Y13040 | Product Code | GM-NEWZ-Y13004 | Product Code | GM-NEWZ-Y13038 | Product Code | GM-NEWZ-Y13039 |
| Description | 100mm Post Jointer | Description | Bottom Jointer | Description | Window Shed Main Beam | Description | Drop Cover |
| | | | | | | | |
| Product Code | GM-NEWZ-117 | Product Code | GM-NEWZ-191 | Product Code | GM-NEWZ-118 | Product Code | NZJT-022 |
| Description | 4.2mm Middle PC Board Base | Description | 4.2mm Side PC Board Base | Description | 4.2mm PC Board Clip | Description | 4.2mm PC Board Rubber |

| | | | | | | | |
|---|---------------------------------|---|-------------------------|--|----------------------|---|------------------------|
|  | |  | |  | |  | |
| Product Code | GM-NEWZ-Y13065 | Product Code | GM-NEWZ-Y13056 | Product Code | GM-NEWZ-Y13062 | Product Code | GM-NEWZ-Y13057 |
| Description | New A3 Edge Frame | Description | A5 Side Post | Description | A5 Side Frame | Description | Board Holder |
|  | |  | |  | |  | |
| Product Code | GM-80x80x2.5R | Product Code | GM-NEWZ-Y13063 | Product Code | GM-NEWZ-Y13064 | Product Code | GM-NEWZ-Y13058 |
| Description | A5 80mm Post | Description | A5 Straight Edge Gutter | Description | A5 Round Edge Gutter | Description | A5 Post Flange Plate |
|  | |  | |  | |  | |
| Product Code | GM-NEWZ-Y13063-64 End Cap | Product Code | GM-76x44x2.0 | Product Code | GM-NEWZ-50x50x3 | Product Code | GM-NEWZ-Y13059 End Cap |
| Description | Straight / Round Gutter End Cap | Description | | Description | | Description | A5 Wall Edge End Cap |
|  | |  | |  | |  | |
| Product Code | GM-NEWZ-Y13059 | Product Code | GM-NEWZ-Y13060 | Product Code | GM-NEWZ-Y13066 | Product Code | GM-D49.5x0.8 |
| Description | A5 Wall Edge | Description | Strengthen Frame | Description | One-Piece Main Frame | Description | 50mm Drain Pipe |
|  | | | | | | | |
| Product Code | GM-NEWZ-Y13061 | | | | | | |
| Description | Double-slot Support Bar | | | | | | |

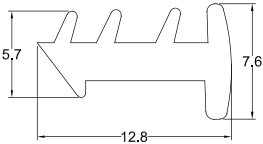
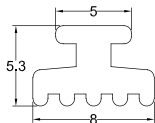
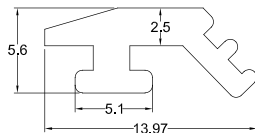
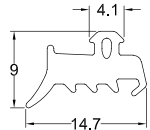
| | | | | | | | |
|---|-----------------------------|---|--------------------------|--|--------------------------------|---|--------------------------------|
|  | |  | |  | |  | |
| Product Code | SL-148 | Product Code | SL-149 | Product Code | SL-188 | Product Code | SL-189 |
| Description | Wall Connector Cover | Description | Wall Connector | Description | Wall Screw | Description | Wall Screw Cover |
|  | |  | |  | |  | |
| Product Code | SL-190 | Product Code | SL-187 | Product Code | SL-114 | Product Code | SL-116 |
| Description | Wall Screw Cap | Description | M8 Expansion Bolt | Description | 40mm Bend Pipe Connector | Description | 40mm Drain Pipe Clamp |
|  | |  | |  | |  | |
| Product Code | SL-115 | Product Code | SL-255 | Product Code | SL-256 | Product Code | SL-254 |
| Description | Plastic 40mm Pipe Connector | Description | Aluminium 50mm Connector | Description | 50mm Drain Pipe Clamp | Description | 50mm Bend Pipe Connector |
|  | |  | |  | |  | |
| Product Code | SL-138 | Product Code | SL-145 | Product Code | PC Endurance Board | | SL-120 |
| Description | Aluminium Corner Bracket | Description | Top Beam Cap | Description | 2.0mm / 3.0mm | | Galvanized Flat Jointer |
|  | |  | |  | |  | |
| Product Code | SL-134 | Product Code | SL-122 | Product Code | M8x16 | Product Code | M4x16 |
| Description | 90° 600x500mm Connector | Description | 90° Angle Connector | Description | Plain Stainless Steel Hex Bolt | Description | Stainless Steel Pan Self Drill |

| | | | | | | | |
|---|-----------------------------|---|-----------------------------|--|-----------------------------|---|---------------------------|
|  | |  | |  | |  | |
| Product Code | SL-212 | Product Code | SL-207 | Product Code | SL-211 | Product Code | SL-208 |
| Description | 100mm Corner Jointer | Description | 120mm Corner Jointer | Description | 100mm Straight Jointer | Description | 120mm Straight Jointer |
|  | |  | |  | |  | |
| Product Code | SL-209 | Product Code | SL-210 | Product Code | SL-198 | Product Code | SL-199 |
| Description | 100mm Post Bracket | Description | 120mm Post Bracket | Description | 100mm Post Anchor | Description | 120mm Post Anchor |
|  | |  | |  | |  | |
| Product Code | SL-200 | Product Code | SL-206 | Product Code | SL-203 | Product Code | SL-205 |
| Description | 150mm Post Anchor | Description | 80x80mm Frame Bracket | Description | 100x44mm Frame Bracket | Description | 100x50mm Frame Bracket |
|  | |  | |  | |  | |
| Product Code | SL-202 | Product Code | SL-204 | Product Code | SL-201 | Product Code | Screw |
| Description | 100x100mm Frame Bracket | Description | 120x60mm Frame Bracket | Description | 120x120mm Frame Bracket | Description | HEX Washer Head M5.5x25mm |
|  | |  | |  | |  | |
| Product Code | PC Endurance Board Sealer 2 | Product Code | PC Endurance Board Sealer 1 | Product Code | PC Endurance Board Sealer 3 | Product Code | NZJT-022 |
| Description | | Description | | Description | | Description | 4.2mm PC Board Rubber |

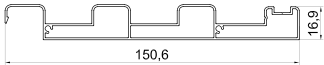
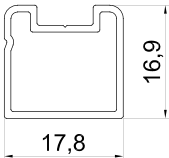
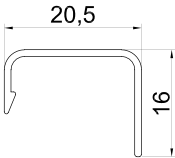
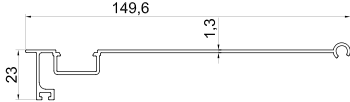
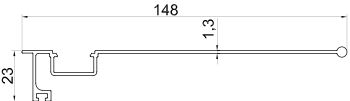
Aluminium Roofing System

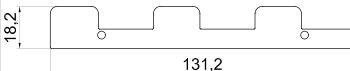
| | | | | | | | |
|--|---------------|---|---------------|--|---------------|---|---------------|
|  | |  | |  | |  | |
| Product Code | GM-NEWZ-CCB01 | Product Code | GM-NEWZ-CCB02 | Product Code | GM-NEWZ-CCB03 | Product Code | GM-NEWZ-CCB04 |
| Description | 1.065 | Description | 0.192 | Description | 0.116 | Description | 0.781 |
|  | |  | |  | | | |
| Product Code | GM-NEWZ-CCB05 | Product Code | GM-NEWZ-CCB06 | Product Code | GM-NEWZ-CCB07 | | |
| Description | 0.779 | Description | 0.074 | Description | 0.074 | | |

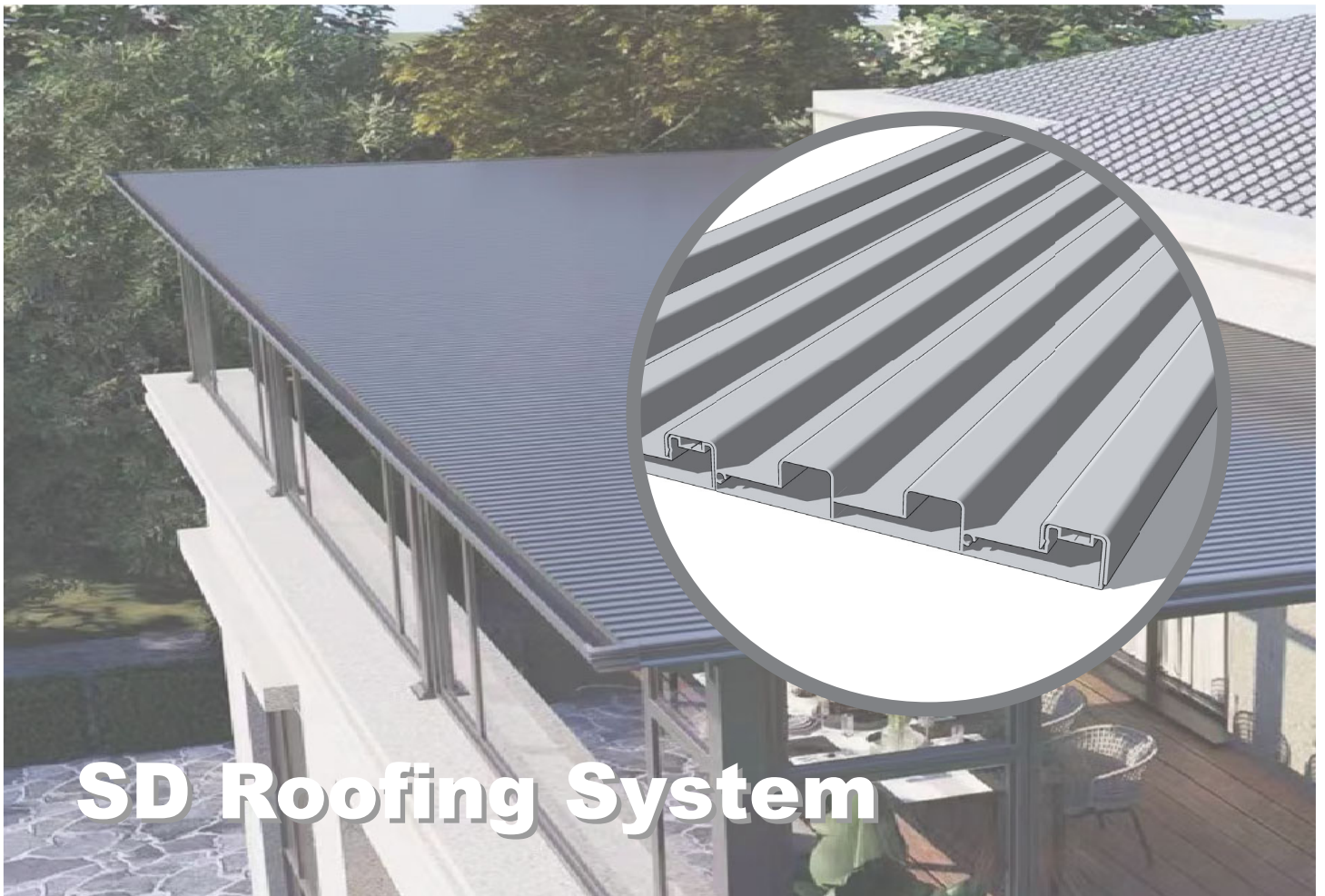

SD Roofing System

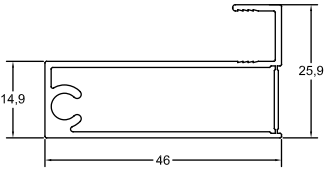
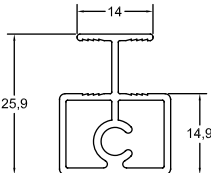
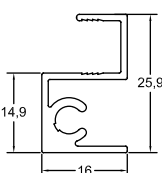
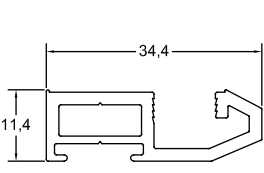
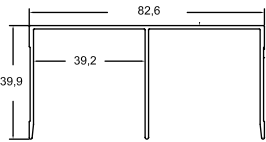
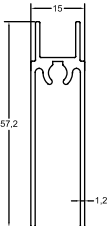
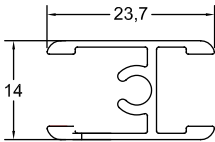
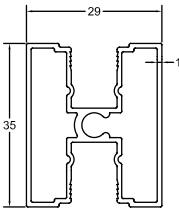
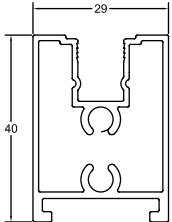
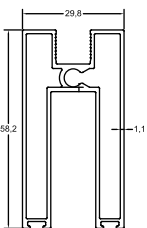
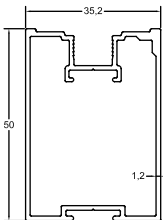
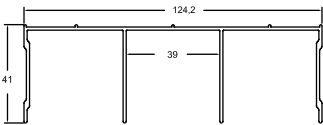
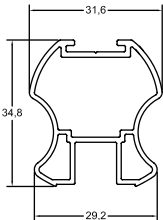
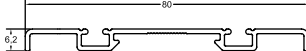
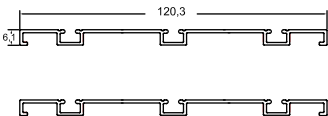
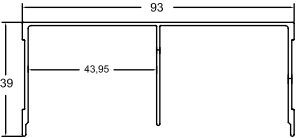
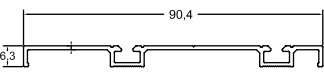
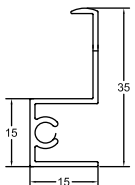
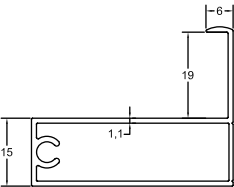
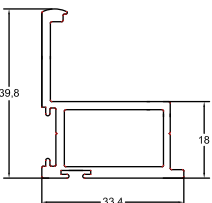
| | | | | | | | |
|---|------------|---|------------|--|------------|---|------------|
|  | |  | |  | |  | |
| Product Code | GM-BGM-A01 | Product Code | GM-BGM-A02 | Product Code | GM-BGM-A03 | Product Code | GM-BGM-A04 |
| Weight (Kg/m) | 0.513 | Weight (Kg/m) | 0.388 | Weight (Kg/m) | 0.310 | Weight (Kg/m) | 0.420 |
|  | |  | |  | |  | |
| Product Code | GM-BGM-A05 | Product Code | GM-BGM-A06 | Product Code | GM-BGM-A07 | Product Code | GM-BGM-A08 |
| Weight (Kg/m) | 0.692 | Weight (Kg/m) | 0.520 | Weight (Kg/m) | 0.235 | Weight (Kg/m) | 0.550 |
|  | |  | |  | |  | |
| Product Code | GM-BGM-A09 | Product Code | GM-BGM-A10 | Product Code | GM-BGM-A11 | Product Code | GM-BGM-A12 |
| Weight (Kg/m) | 0.733 | Weight (Kg/m) | 0.920 | Weight (Kg/m) | 0.714 | Weight (Kg/m) | 1.08 |
|  | |  | |  | |  | |
| Product Code | GM-BGM-A13 | Product Code | GM-BGM-A14 | Product Code | GM-BGM-A15 | Product Code | GM-BGM-B01 |
| Weight (Kg/m) | 0.523 | Weight (Kg/m) | 0.430 | Weight (Kg/m) | 0.580 | Weight (Kg/m) | 0.700 |
|  | |  | |  | |  | |
| Product Code | GM-BGM-B02 | Product Code | GM-BGM-B03 | Product Code | GM-BGM-B04 | Product Code | GM-BGM-B05 |
| Weight (Kg/m) | 0.450 | Weight (Kg/m) | 0.248 | Weight (Kg/m) | 0.466 | Weight (Kg/m) | 0.681 |

| | | | | | | | |
|---------------|--------------------|---------------|--------------------------|---------------|----------------------|---------------|---------------------------|
| | | | | | | | |
| Product Code | GM-BGM-B06 | Product Code | GM-NEWZ-42 | Product Code | GM-NEWZ-43 | Product Code | GM-NEWZ-44 |
| Weight (Kg/m) | 0.331 | Weight (Kg/m) | 0.114 | Weight (Kg/m) | 0.107 | Weight (Kg/m) | 0.094 |
| | | | | | | | |
| Product Code | GM-NEWZ-41 | Product Code | GM-NEWZ-40 | Product Code | GM-NEWZ-34.5x12x1.2R | Product Code | SL76 |
| Weight (Kg/m) | 0.360 | Weight (Kg/m) | 0.518 | Weight (Kg/m) | 0.300 | Description | Rail End Support - Square |
| | | | | | | | |
| Product Code | GM-NEWZ-66 | Product Code | SL73 | Product Code | SL81SP | Product Code | SL81 |
| Weight (Kg/m) | 0.268 | Description | Rail End Support - Round | Description | Rail End Support | Description | Rail Centre Support |
| | | | | | | | |
| Product Code | SL04 | Product Code | SL05 | Product Code | SL14 | Product Code | SL110 |
| Description | L Shape Handke Cap | Description | U Shape Handke Cap | Description | L / U Shape Handle | Description | Cabinet Feet |
| | | | | | | | |
| Product Code | C1202-A1 | | | | | | |
| Description | Shelf Support | | | | | | |

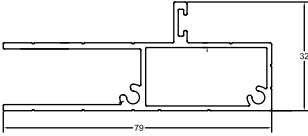
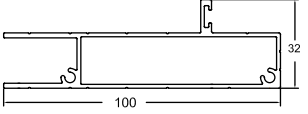
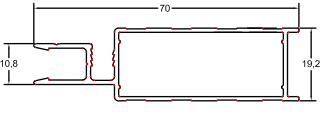
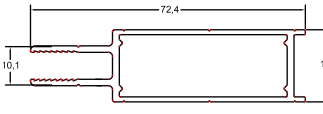
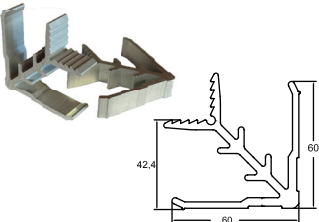
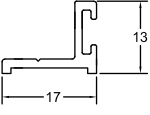
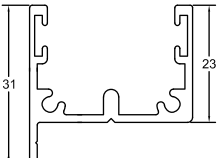
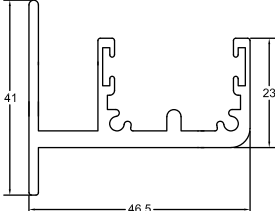
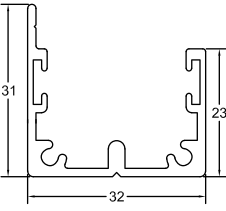
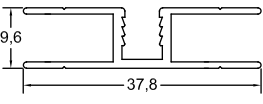
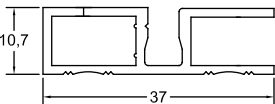
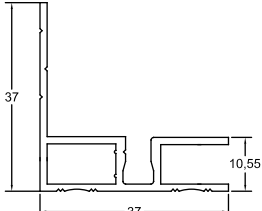
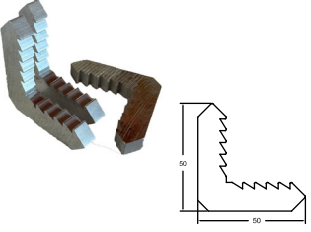
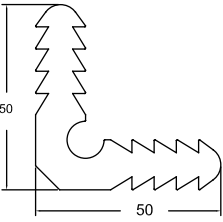
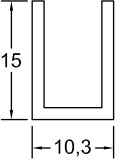
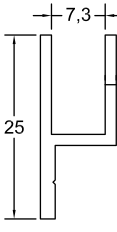
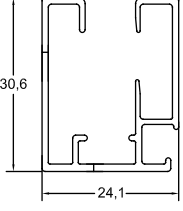
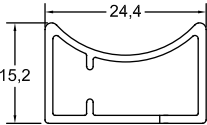
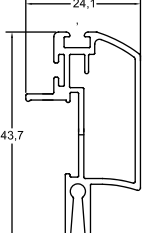
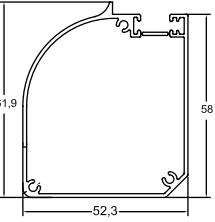
| | | | | | | | |
|---|-------------|---|-------------|--|-----------------|---|-------------|
|  | |  | |  | |  | |
| Product Code | GM-NEWZ-W24 | Product Code | GM-NEWZ-W28 | Product Code | GM-NEWZ-W25 | Product Code | GM-NEWZ-W26 |
| Weight (Kg/m) | 1.022 | Weight (Kg/m) | 1.150 | Weight (Kg/m) | 0.564 | Weight (Kg/m) | 0.750 |
|  | |  | |  | |  | |
| Product Code | GM-NEWZ-W27 | Product Code | GM-NEWZ-W29 | Product Code | GM-NEWZ-W30 | Product Code | GM-NEWZ-W31 |
| Weight (Kg/m) | 2.410 | Weight (Kg/m) | 0.1 | Weight (Kg/m) | 0.510 | Weight (Kg/m) | 0.984 |
|  | |  | |  | |  | |
| Product Code | GM-NEWZ-W32 | Product Code | GM-NEWZ-W33 | Product Code | GM-NEWZ-W34 | Product Code | GM-NEWZ-W35 |
| Weight (Kg/m) | 0.510 | Weight (Kg/m) | 0.273 | Weight (Kg/m) | 0.370 | Weight (Kg/m) | 0.474 |
|  | |  | |  | |  | |
| Product Code | GM-NEWZ-W36 | Product Code | GM-NEWZ-W37 | Product Code | CLSA10.3B15T1.5 | Product Code | GM-NEWZ-151 |
| Weight (Kg/m) | 2.805 | Weight (Kg/m) | 2.493 | Weight (Kg/m) | 0.160 | Weight (Kg/m) | 0.217 |
|  | |  | |  | |  | |
| Product Code | GM-NEWZ-84 | Product Code | GM-NEWZ-85 | Product Code | GM-NEWZ-86 | Product Code | GM-NEWZ-87 |
| Weight (Kg/m) | 0.390 | Weight (Kg/m) | 0.264 | Weight (Kg/m) | 0.500 | Weight (Kg/m) | 0.830 |

| | | | | | |
|---------------|------------|---------------|------------|--|--------------|
| | | | | <p>Wall Mount Channel for: NEWZ-24 & NEWZ-28</p> | |
| Product Code | GM-NEWZ-91 | Product Code | GM-NEWZ-89 | Product Code | CLA16B16T1.6 |
| Weight (Kg/m) | 0.233 | Weight (Kg/m) | 0.970 | Weight (Kg/m) | 0.204 |

Security Grilles & Meshes

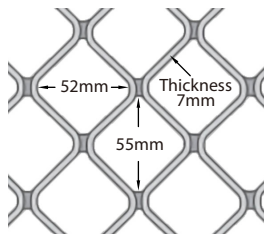

Aluminium 52x55 Grille

| Product Description | Thickness (mm) | Size (mm) |
|-----------------------|----------------|-------------|
| 52x55 Security Grille | 7.00 | 750 x 2000 |
| | | 750 x 4000 |
| | | 920 x 2000 |
| | | 920 x 4000 |
| | | 1250 x 2000 |
| | | 1250 x 4000 |

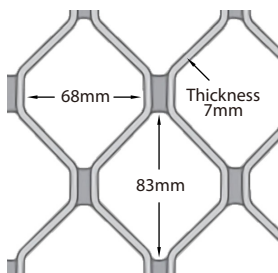

Aluminium 68x83 Grille

| Product Description | Thickness (mm) | Size (mm) |
|-----------------------|----------------|-------------|
| 68x83 Security Grille | 7.00 | 750 x 2000 |
| | | 750 x 4000 |
| | | 920 x 2000 |
| | | 920 x 4000 |
| | | 1250 x 2000 |
| | | 1250 x 4000 |

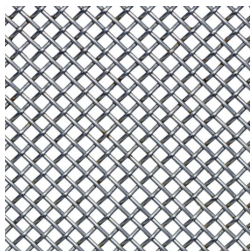

316 Marine Grade Stainless Steel Mesh
0.80mm Thickness

| Product Description | Thickness (mm) | Size (mm) |
|---------------------|----------------|-------------|
| Perforated Screen | 0.80 | 750 x 2000 |
| | | 750 x 4000 |
| | | 920 x 2000 |
| | | 920 x 4000 |
| | | 1250 x 2000 |
| | | 1250 x 4000 |

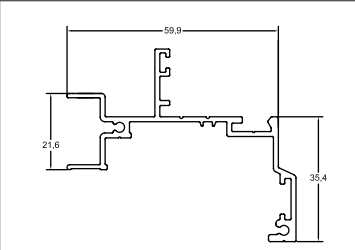
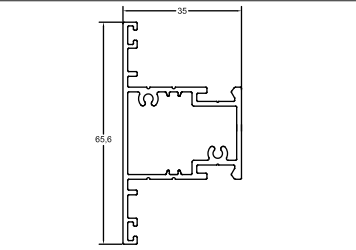
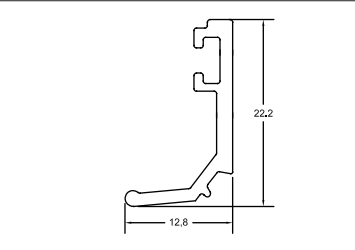
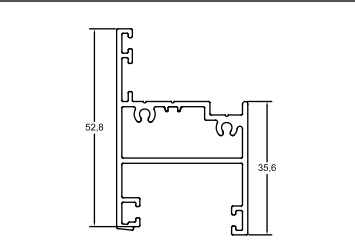
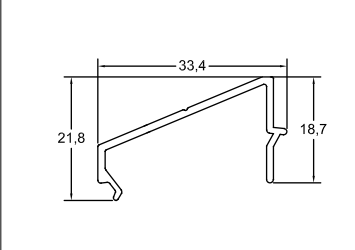
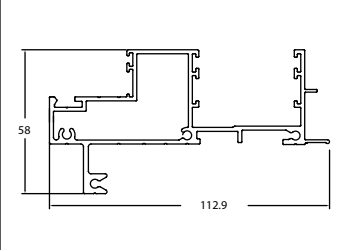
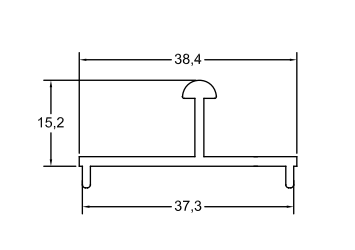
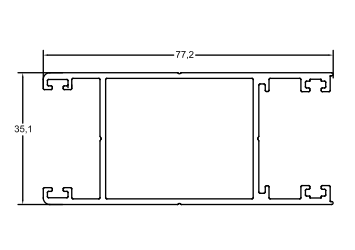
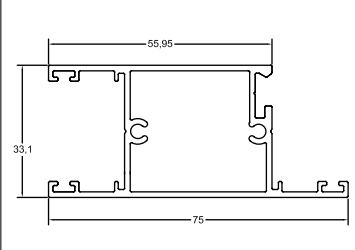
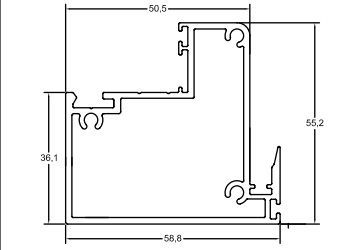
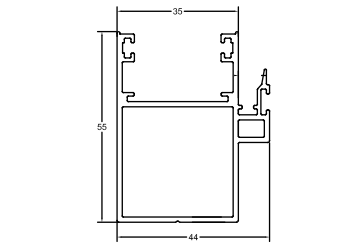
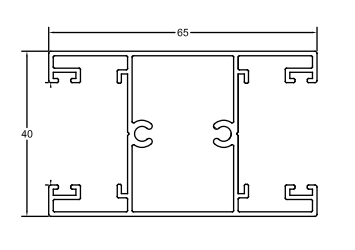
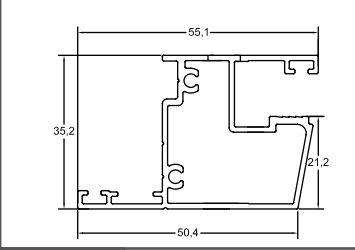
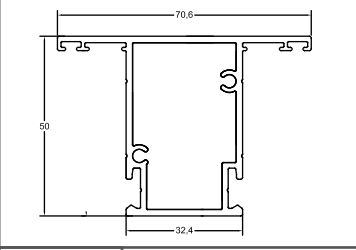
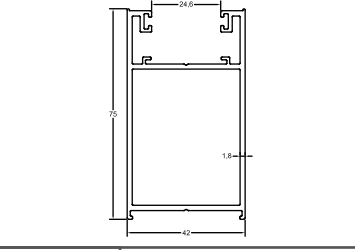
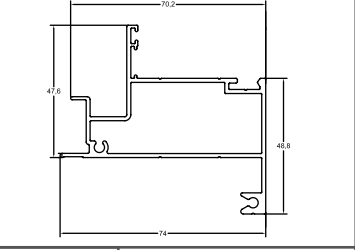
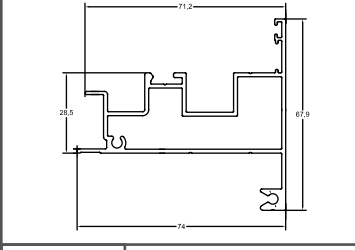
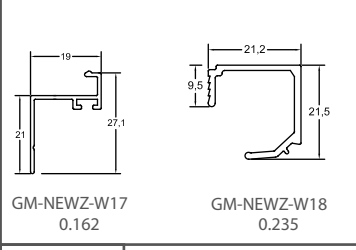
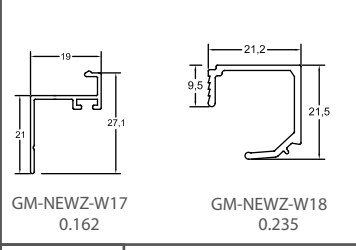
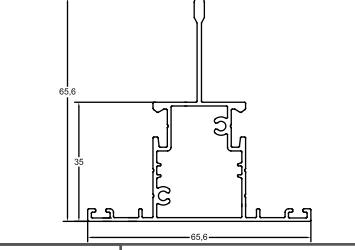
| | | | | | | | |
|--|-------------|---|------------------|---|-------------|---|-------------|
|  | |  | |  | |  | |
| Product Code | GM-NEWZ-W01 | Product Code | GM-NEWZ-W02 | Product Code | GM-NEWZ-W03 | Product Code | GM-NEWZ-W04 |
| Weight (Kg/m) | 0.771 | Weight (Kg/m) | 0.875 | Weight (Kg/m) | 0.175 | Weight (Kg/m) | 0.824 |
|  | |  | |  | |  | |
| Product Code | GM-NEWZ-W05 | Product Code | GM-NEWZ-W06 | Product Code | GM-NEWZ-W07 | Product Code | GM-NEWZ-W08 |
| Weight (Kg/m) | 0.230 | Weight (Kg/m) | 1.830 | Weight (Kg/m) | 0.310 | Weight (Kg/m) | 1.100 |
|  | |  | |  | |  | |
| Product Code | GM-NEWZ-W09 | Product Code | GM-NEWZ-W10 | Product Code | GM-NEWZ-W11 | Product Code | GM-NEWZ-W12 |
| Weight (Kg/m) | 0.970 | Weight (Kg/m) | 1.310 | Weight (Kg/m) | 1.000 | Weight (Kg/m) | 1.030 |
|  | |  | |  | |  | |
| Product Code | GM-NEWZ-W21 | Product Code | GM-NEWZ-W13 | Product Code | GM-NEWZ-W14 | Product Code | GM-NEWZ-W15 |
| Weight (Kg/m) | 0.755 | Weight (Kg/m) | 1.180 | Weight (Kg/m) | 1.330 | Weight (Kg/m) | 1.190 |
|  | |  GM-NEWZ-W17 0.162 | |  GM-NEWZ-W18 0.235 | |  | |
| Product Code | GM-NEWZ-W16 | Product Code | GM-NEWZ-W17 / 18 | Product Code | GM-NEWZ-W20 | | |
| Weight (Kg/m) | 1.260 | Weight (Kg/m) | 0.162 & 0.235 | Weight (Kg/m) | 0.855 | | |

"✓" Stocked Item
 "*" Pre-order Only Item
 (30-40 working days delivery)



Window Support Bars

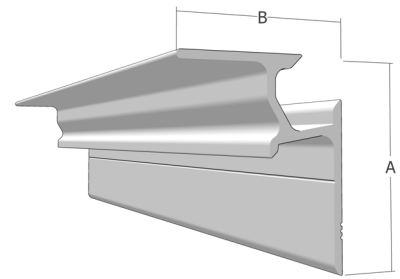

| Product Code | Ex Stock | A (mm) | B (mm) | Mass (kg/m) | Perimeter (Kg/m) | Area (mm ²) |
|--------------|----------|--------|--------|-------------|------------------|-------------------------|
| GM-NEWZ-99 | ✓ | 50 | 20 | 0.50 | 163.28 | 174.78 |
| GM-NEWZ-17 | ✓ | 50 | 30 | 0.57 | 183.27 | 200.00 |
| GM-NEWZ-16 | ✓ | 50 | 40 | 0.63 | 203.28 | 220.56 |
| GM-NEWZ-15 | ✓ | 60 | 50 | 0.76 | 243.40 | 266.70 |

Top-Fix Support Bars

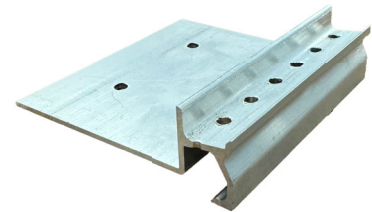

| Product Code | Ex Stock | A (mm) | B (mm) | C (mm) | Mass (kg/m) | Perimeter (Kg/m) | Area (mm ²) |
|--------------|----------|--------|--------|--------|-------------|------------------|-------------------------|
| GM-NEWZ-19 | ✓ | 19 | 22.8 | 23.2 | 0.810 | 274.74 | 384.37 |
| GM-NEWZ-20 | ✓ | 30 | 22.8 | 23.2 | 0.868 | 294.65 | 304.59 |
| GM-NEWZ-21 | ✓ | 40 | 24.8 | 23.2 | 1.040 | 319.17 | 364.91 |
| GM-NEWZ-22 | ✓ | 55 | 24.8 | 23.2 | 1.130 | 349.17 | 396.66 |



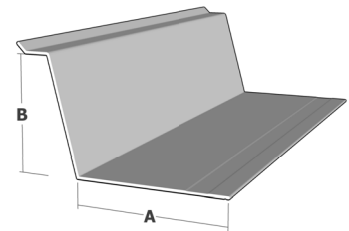

Head Flashings

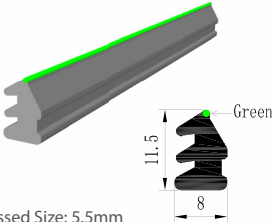
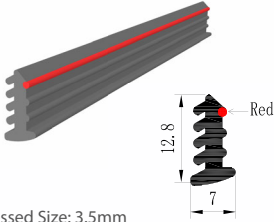
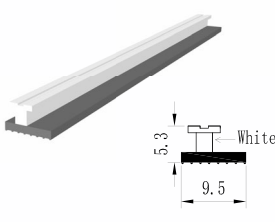
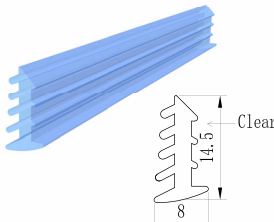
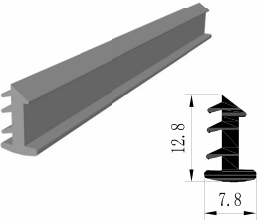
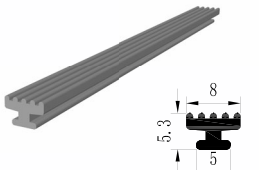
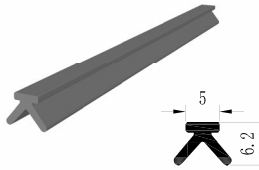
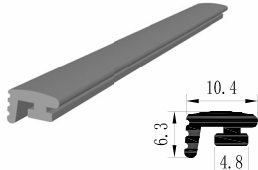
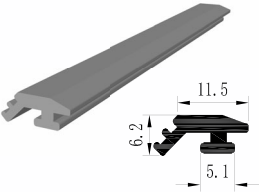
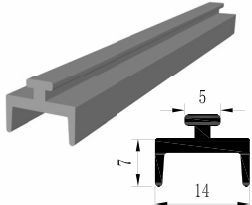
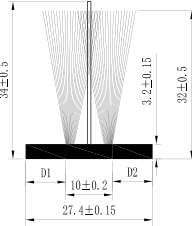
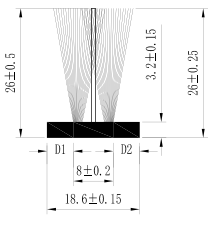

| Product Code | Ex Stock | A (mm) | B (mm) | Surface Treatment | Length (m) |
|--------------|----------|--------|--------|---|------------|
| GM-NEWZ-187 | ✓ | 66 | 20 | Matt Black, Matt Ironsand, Matt Titania, Silver Pearl, Matt Charcoal, Matt Sandstone Grey | 6 |
| GM-NEWZ-188 | ✓ | 66 | 30 | | 6 |
| GM-NEWZ-189 | ✓ | 66 | 40 | | 6 |
| GM-NEWZ-124 | ✓ | 66 | 50 | | 6 |
| GM-NEWZ-18 | ✓ | 66 | 60 | | 6 |
| GM-NEWZ-10 | ✓ | 66 | 70 | | 6 |
| GM-NEWZ-75 | ✓ | 66 | 85 | | 6 |

| | | | | | | | |
|---|-----------------------|---|-------------------------------|---|----------------------|--|--------------------|
|  <p>Max Sash Height: 750mm Max Sash Weight: 6kg</p> | |  <p>Max Sash Height: 1000mm Max Sash Weight: 9kg</p> | |  <p>Max Sash Height: 1300mm Max Sash Weight: 12kg</p> | |  <p>Max Window Opening: 100mm</p> | |
| Product Code | BA230B/BP235B | Product Code | BA330B/BP335B | Product Code | BA500B/BP510B | Product Code | SL101 |
| Description | 235mm Friction Stay | Description | 330mm Friction Stay | Description | 510mm Friction Stay | Description | Safety Stay |
|  | |  <p>Zinc Alloy Comes in White & Matt Black</p> | |  <p>Zinc Alloy Comes in White & Matt Black</p> | |  | |
| Product Code | MS07 | Product Code | MS01 | Product Code | MS03 | Product Code | MY01 |
| Description | Locker Cylinder | Description | Flat Trim Lever Handle Locker | Description | Sliding Door Locker | Description | Security Hinge |
|  | |  | |  <p>Sliding</p> | |  <p>4.7 Clear 7.08 10.26</p> | |
| Product Code | MY01 | Product Code | MS10 | Product Code | MS11 | Product Code | NZJT-001 |
| Description | Sliding Door Carridge | Description | Trim Lever Handle Lock | Description | Sliding 3-point Lock | Description | |
|  <p>4.9 Clear 9.5 8.83</p> | |  <p>4.9 Clear 8.81</p> | |  <p>4.9 Clear 7 10.04</p> | |  <p>4.2 Blue 9.4 4.4 Compressed Size: 2.0mm</p> | |
| Product Code | NZJT-002 | Product Code | NZJT-003 | Product Code | NZJT-004 | Product Code | NZJT-005 |
| Description | | Description | | Description | | Description | PVC Low Rise Wedge |
|  <p>5.26 Red 9.6 5.6 3.00 Compressed Size: 3.5mm</p> | |  <p>6 Orange 10 6.2 8 Compressed Size: 4.0mm</p> | |  <p>11 Yellow 6.5 Compressed Size: 4.5mm</p> | |  <p>11 White 7 Compressed Size: 5.0mm</p> | |
| Product Code | NZJT-006 | Product Code | NZJT-007 | Product Code | NZJT-021 | Product Code | NZJT-008 |
| Description | PVC Low Rise Wedge | Description | PVC Low Rise Wedge | Description | PVC Low Rise Wedge | Description | PVC Low Rise Wedge |

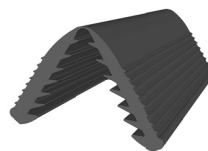

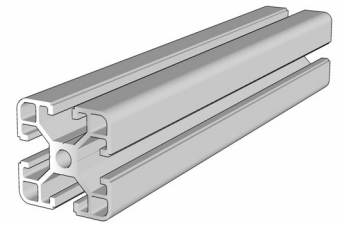

Window & Door Accessories

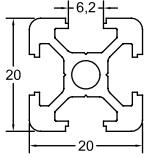
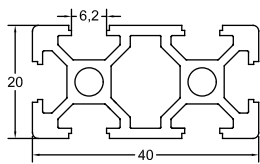
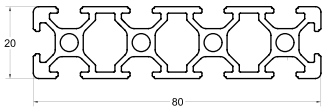
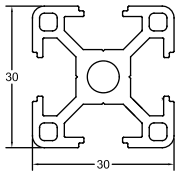
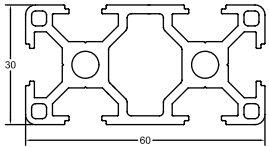
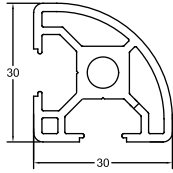
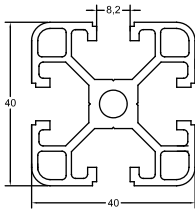
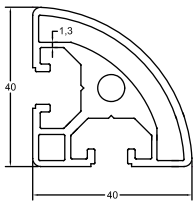
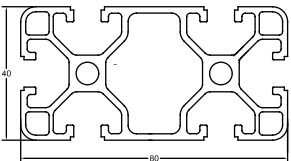
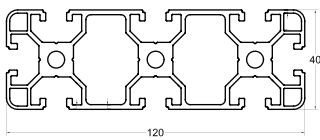
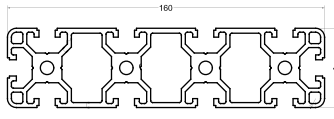
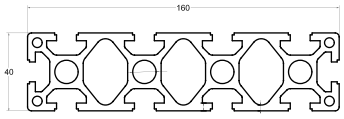
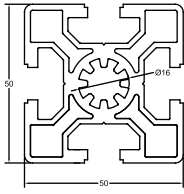
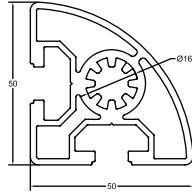
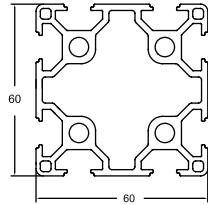
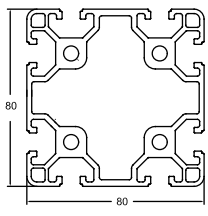
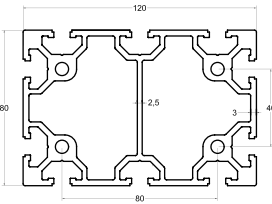
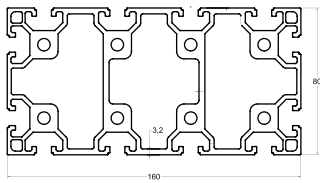
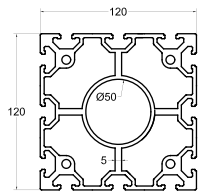
| | | | | | | | |
|---|-----------------------|---|----------------------|--|-----------------------------|---|-----------------------------|
|  <p>Compressed Size: 5.5mm</p> | |  <p>Compressed Size: 3.5mm</p> | |  | |  | |
| Product Code | NZJT-009 | Product Code | NZJT-010 | Product Code | NZJT-012 | Product Code | NZJT-013 |
| Description | 8.0mm Low Rise Wedge | Description | PVC Wedge Rubber | Description | | Description | Clear PVC Wedge |
|  | |  | |  <p>Compressed Size: 1.5mm</p> | |  | |
| Product Code | NZJT-014 | Product Code | NZJT-015 | Product Code | NZJT-016 | Product Code | NZJT-017 |
| Description | | Description | | Description | TPV Seal | Description | |
|  | |  | |  | |  | |
| Product Code | NZJT-018 | Product Code | NZJT-019 | Product Code | MT-006 | Product Code | MT-007 |
| Description | | Description | | Description | 34mm Fin Pile Weather Strip | Description | 26mm Fin Pile Weather Strip |
|  | |  | |  | |  | |
| Product Code | SL-01 | Product Code | SL-02 | Product Code | SL-197 / NZJT - 023 | Product Code | SL-198 / NZJT - 024 |
| Description | Supporting Bar Gasket | Description | Head Flashing Gasket | Description | Rubber for 316 Steel Mesh | Description | Rubber for Fly Screen Mesh |

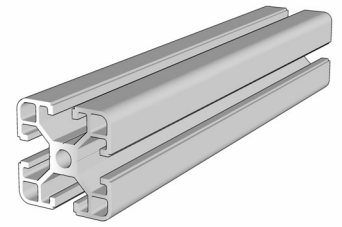

| | | | | | | | |
|--|-------------|--|------------|--|------------|--|------------|
|  <p>20x20mm T-Slot</p> | |  <p>20x40mm T-Slot</p> | |  <p>20x80mm T-Slot</p> | |  <p>30x30mm T-Slot</p> | |
| Product Code | GM-LZ-83 | Product Code | GM-LZ-85 | Product Code | GM-LZ-117 | Product Code | GM-LZ-86 |
| Weight (Kg/m) | 0.470 | Weight (Kg/m) | 0.844 | Weight (Kg/m) | 1.570 | Weight (Kg/m) | 0.930 |
|  <p>30x60mm T-Slot</p> | |  <p>30x30mm T-Slot Corner</p> | |  <p>40x40mm T-Slot</p> | |  <p>40x40mm T-Slot Corner</p> | |
| Product Code | GM-LZ-87 | Product Code | GM-LZ-97 | Product Code | GM-LZ-89 | Product Code | GM-LZ-96 |
| Weight (Kg/m) | 1.700 | Weight (Kg/m) | 0.842 | Weight (Kg/m) | 1.353 | Weight (Kg/m) | 1.380 |
|  <p>40x80mm T-Slot Corner</p> | |  <p>40x120mm T-Slot</p> | |  <p>40x160mm T-Slot</p> | |  <p>40x160mm T-Slot</p> | |
| Product Code | GM-LZ-82 | Product Code | GM-GYFZ-78 | Product Code | GM-LZ-278 | Product Code | GM-GYFZ-62 |
| Weight (Kg/m) | 2.313 | Weight (Kg/m) | 3.610 | Weight (Kg/m) | 5.750 | Weight (Kg/m) | 6.800 |
|  <p>50x50mm T-Slot</p> | |  <p>50x50mm T-Slot Corner</p> | |  <p>60x60mm T-Slot</p> | |  <p>80x80mm T-Slot</p> | |
| Product Code | GM-LZ-78 | Product Code | GM-GYFZ-76 | Product Code | GM-LZ-168 | Product Code | GM-LZ-263 |
| Weight (Kg/m) | 2.524 | Weight (Kg/m) | 1.980 | Weight (Kg/m) | 2.590 | Weight (Kg/m) | 4.670 |
|  <p>80x120mm T-Slot</p> | |  <p>80x160mm T-Slot</p> | |  <p>120x120mm T-Slot</p> | | | |
| Product Code | GM-GYFZ-003 | Product Code | GM-LZ-21 | Product Code | GM-GYFZ-67 | | |
| Weight (Kg/m) | 7.000 | Weight (Kg/m) | 9.620 | Weight (Kg/m) | 10.400 | | |

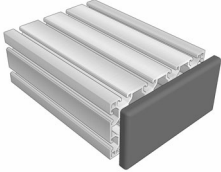

| | | | | | | | |
|---|------------------------|---|------------------------|--|------------------------|---|------------------------|
|  | |  | |  | |  | |
| Product Code | XXXXXX | Product Code | | Product Code | | Product Code | |
| Description | 20x20 T-Slot End Cap | Description | 20x40 T-Slot End Cap | Description | 20x80 T-Slot End Cap | Description | 30x30 T-Slot End Cap |
|  | |  | |  | |  | |
| Product Code | | Product Code | | Product Code | | Product Code | |
| Description | 30x60 T-Slot End Cap | Description | 40x40 T-Slot End Cap | Description | 40x80 T-Slot End Cap | Description | 40x160 T-Slot End Cap |
|  | |  | |  | |  | |
| Product Code | | Product Code | | Product Code | | Product Code | |
| Description | 50x50 T-Slot End Cap | Description | 60x60 T-Slot End Cap | Description | 80x80 T-Slot End Cap | Description | 80x120 T-Slot End Cap |
|  | |  | |  | |  | |
| Product Code | | Product Code | | Product Code | TS35 | Product Code | TS36 |
| Description | 80x160 T-Slot End Cap | Description | 120x120 T-Slot End Cap | Description | 20mm T-Slot Bracket | Description | 30mm T-Slot Bracket |
|  | |  | |  | |  | |
| Product Code | TS37 | Product Code | TS38 | Product Code | TS39 | Product Code | TS42 |
| Description | 30x60mm T-Slot Bracket | Description | 40mm T-Slot Bracket | Description | 40x80mm T-Slot Bracket | Description | 45x45mm T-Slot Bracket |

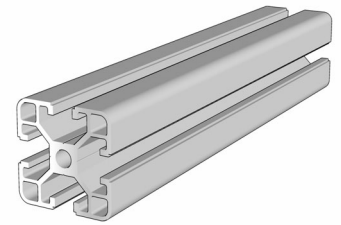

| | | | | | | | |
|-----------------------------|---------------------------|---------------------|----------------------------|----------------------|-----------------------------|--|---------------------------|
| | | | | | | | |
| Product Code | TS40 | Product Code | TS41 | Product Code | TS03 | Product Code | SP19-1 |
| Description | 60x60mm T-Slot Bracket | Description | 80mm T-Slot Bracket | Description | Wheel Base Plate | Description | T-Slot Wheel |
| | | | | | | | |
| Product Code | SP19-2 | Product Code | | Product Code | TS42 | Product Code | NZJT-025 |
| Description | T-Slot Wheel with break | Description | 30mm 3-way Jointer | Description | 40mm 3-way Jointer | Description | 30 / 40mm Sealing Strip |
| | | | | | | | |
| Product Code | NZJT-027 | Product Code | NZJT-028 | Product Code | NZJT-026 | Product Code | SL-226 |
| Description | 60mm Sealing Strip | Description | 40mm Sealing Strip | Description | 20mm Sealing Strip | Description | HD Corner Stake for 30x60 |
| | | | | | | | |
| for 40x80mm T-Slot | | for 40x120mm T-Slot | | for 120x120mm T-Slot | | for 30/40mm T-Slot M6 Screw | |
| Product Code | SL-227 | Product Code | SL-228 | Product Code | SL-229 | Product Code | SL-230 |
| Description | HD Corner Stake for 40x80 | Description | HD Corner Stake for 40x120 | Description | HD Corner Stake for 120x120 | Description | Shrapnel Nut for M6 Screw |
| | | | | | | | |
| for 30/40mm T-Slot M8 Screw | | for 30x60mm system | | for 40x80mm system | | Comes with Sliding Nut Screws, and Round Nut | |
| Product Code | SL-231 | Product Code | SL-232 | Product Code | SL-233 | Product Code | SL-234 |
| Description | Shrapnel Nut for M8 Screw | Description | 30x60mm Joint Plate | Description | 40x80mm Joint Plate | Description | 30mm Internal Joint Set |

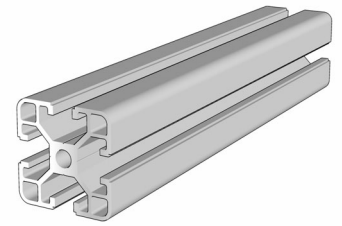

| | | | | | | | |
|---|---------------------------|--|------------------------------|--|------------------------------|---|------------------------------|
|  <p>Comes with Sliding Nut Screws, and Round Nut</p> | |  <p>Comes with Screws</p> | |  <p>Comes with Screws</p> | |  <p>Comes with Screws</p> | |
| Product Code | SL-235 | Product Code | SL-236 | Product Code | SL-237 | Product Code | SL-238 |
| Description | 40mm Internal Joint Set | Description | 20mm Internal Corner Jointer | Description | 30mm Internal Corner Jointer | Description | 40mm Internal Corner Jointer |
|  <p>Comes with Screws</p> | |  <p>Comes with Screws</p> | |  <p>Comes with Screws</p> | |  <p>Comes with Screws</p> | |
| Product Code | SL-239 | Product Code | SL-240 | Product Code | SL-241 | Product Code | SL-242 |
| Description | 20mm Pivot Corner Jointer | Description | 30mm Pivot Corner Jointer | Description | 40mm Pivot Corner Jointer | Description | 30mm 45° Corner Jointer |
|  <p>Comes with Screws</p> | |  <p>Comes with Screws</p> | |  <p>Comes with Screws</p> | |  <p>Comes with Screws</p> | |
| Product Code | SL-243 | Product Code | SL-244 | Product Code | SL-250 | Product Code | SL-251 |
| Description | 30mm 135° Corner Jointer | Description | 40mm 135° Corner Jointer | Description | 30mm Hinge | Description | 40mm Hinge |
|  <p>Comes with Screws and Nuts</p> | | | | | | | |
| Product Code | SL-252 | | | | | | |
| Description | 90mm handle set | | | | | | |

Stair Mouldings

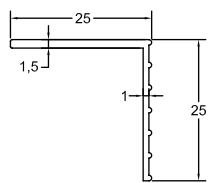
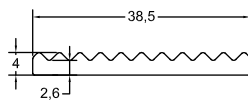
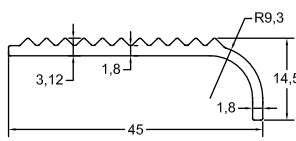
| | | | | | |
|---|--------------------------|---|-----------------------------|--|--------------------------|
|  | |  | |  | |
| Product Code | GM-NEWZ-W39 Fluted Angle | Product Code | GM-NEWZ-W40 Fluted Flat Bar | Product Code | GM-NEWZ-W41 Stair Nosing |
| Weight (Kg/m) | 0.180 | Weight (Kg/m) | 0.364 | Weight (Kg/m) | 0.336 |

Awning Tracks

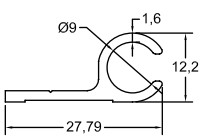
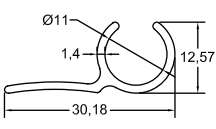
| | | | |
|---|--------------------------|---|-----------------------------|
|  | |  | |
| Product Code | GM-GFX-70 9mm Sail Track | Product Code | GM-NEWZ-150 11mm Sail Track |
| Weight (Kg/m) | 0.220 | Weight (Kg/m) | 0.203 |

Y-Post / Waratah Systems and Mesh Options









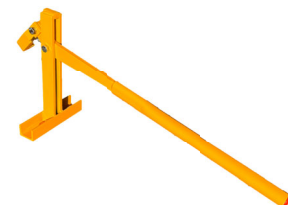

Galvanized Steel Y Posts - Painted Black

Hot-dip galvanisation for maximum corrosion protection in harsh environments. Primarily used for Temporary Fencing, Gardening and Concrete Boxing applications.



Weight: 1.80kg/m approx.

| Product Code | Length | Holes |
|--------------|--------|-------|
| SYP0.45M | 450mm | 2 |
| SYP0.6M | 600mm | 3 |
| SYP0.8M | 800mm | 5 |
| SYP0.9M | 900mm | 5 |
| SYP1.2M | 1200mm | 11 |
| SYP1.35M | 1350mm | 11 |
| SYP1.5M | 1500mm | 14 |
| SYP1.65M | 1650mm | 14 |
| SYP1.8M | 1800mm | 14 |
| SYP2.4M | 2400mm | 17 |
| SYP2.7M | 2700mm | 17 |
| SYP3M | 3000mm | 17 |

| | | | | | | | |
|---|---------------------------|--|--------------------|---|-----------------------------|---|-----------------------------|
|  | |  | |  | |  | |
| Product Code | SL-45 | Product Code | SL-47 | Product Code | SL-20 | Product Code | SL-21 |
| Description | Post Rammer | Description | Post Lifter | Description | Round Safety Cap | Weight (Kg/m) | Triangle Safety Cap |
|  | |  Wire Diametre: 2.0mm Vertical Spacing: 140mm 1.2m(Height) X 50m(Length) | |  Wire Diametre: 2.0mm Vertical Spacing: 140mm 1.5m (Height) X 50m (Length) | |  Wire Diametre: 2.5mm Diamond Spacing: 50x50mm 0.9m (Height) X 20m (Length) | |
| Product Code | GM-GYFZ-67 | Product Code | FSFH1.2L50 | Product Code | FSFH1.5L50 | Product Code | CFH0.9L20 |
| Description | Wire Strainer | Description | Sheep Fence Mesh | Description | Sheep Fence Mesh | Description | Chain Link Fence Mesh |
|  Wire Diametre: 2.5mm Diamond Spacing: 50x50mm 0.9m(Height) X 20m(Length) | |  Weight: 100g/m ² 1m(Height) X 50m(Length) | |  Hot Dip Galvanized Net 25 0.9m(Height) X 9m(Length) | |  Hot Dip Galvanized Net 13 1m(Height) X 9m(Length) | |
| Product Code | CFH0.9L20PVC | Product Code | SMW1L50RED | Product Code | SWWFH0.914NS25L9 | Product Code | SWWFH1NS13L9 |
| Description | PVC Chain Link Fence Mesh | Description | Orange Safety Mesh | Description | Galvanized Square Wire Mesh | Description | Galvanized Square Wire Mesh |

Temporary Fence Panel

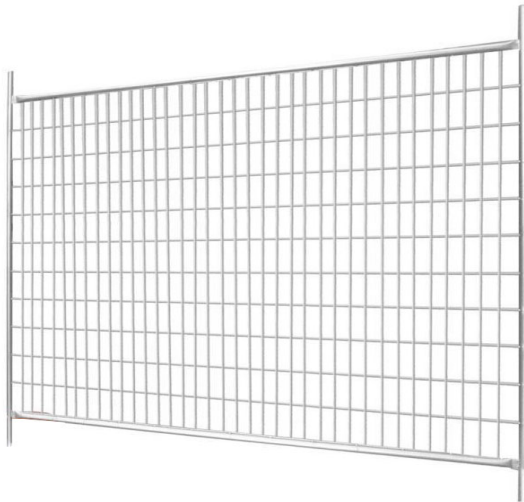

| Product Code | Panel Size |
|--------------|---------------------|
| TFSH2.1L2.4 | 2.4m (W) X 2.1m (H) |

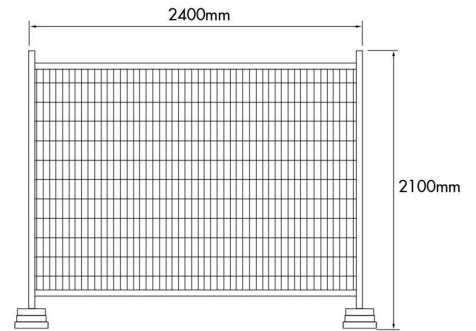



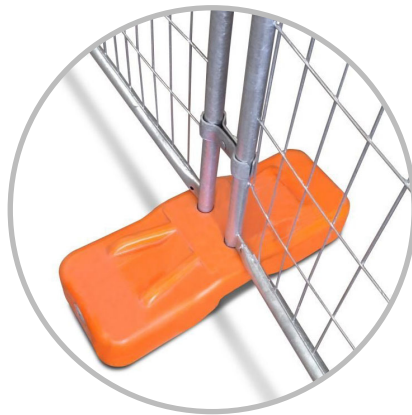

Finish: 14 micron galvanized steel finish
 Mesh: 150mm X 60mm mesh spacing
 2.5mm thickness wire mesh





Hot-dip galvanisation for maximum corrosion protection in harsh environments.
 Primarily used for Civil Construction Projects, Sport Events and Environmental Protection applications.

| | | | | | |
|--------------|----------------------|--------------|-------------|--------------|---------------|
| | | | | | |
| Product Code | SL-71 | Product Code | SL-72 | Product Code | TFBH2.1L2.4 |
| Description | Concrete Filled Foot | Description | Panel Clamp | Description | Panel Bracing |

| | | | | | | | |
|---|------------------------------|---|-----------------------------|--|-------------------------|---|-----------------------|
|  | |  | |  | |  | |
| Product Code | HD108 | Product Code | HD101 | Product Code | SS850 | Product Code | SS511B |
| Description | Kitchen and Bathroom Sealant | Description | General Purpose Sealant | Description | Window and Door Sealant | Description | Silicone Sealant |
|  | |  | |  | |  | |
| Product Code | Sealant Gun 1 | Product Code | Sealant Gun 2 | Product Code | GC5 | Product Code | GC6 |
| Description | | Description | For SS511B Silicone Sealant | Description | 5" - 125mm G Clamp | Description | 6" - 150mm G Clamp |
|  | |  | |  | |  | |
| Product Code | GC10 | Product Code | GC9 | Product Code | SL80 | Product Code | SL79 |
| Description | 10" - 250mm G Clamp | Description | F Heavy Duty Clamp | Description | Handy Wrap Handle | Description | Stretch Wrap Film - S |
|  | |  | |  | |  | |
| Product Code | Stretch Wrap PE | Product Code | PVC -75mmx50m | Product Code | PVC -48mmx50m | Product Code | PVC -36mmx50m |
| Description | Stretch Wrap Film - L | Description | 75mm PVC Orange Tape | Weight (Kg/m) | 48mm PVC Orange Tape | Weight (Kg/m) | 36mm PVC Orange Tape |





CSK Head - Self Tapping Screw 304 Stainless Steel

| Drive Type | Code | Gauge | Thread Diameter | Length |
|---|------|-------|-----------------|--------|
|  Square Drive | D49 | 5g | M3.3 | 17mm |
| | D4 | 8g | M4.2 | 25mm |
|  Philips Drive | D58 | 8g | M4.2 | 38mm |
| | D57 | 8g | M4.2 | 50mm |
| | D59 | 8g | M4.2 | 60mm |
|  Int Hex Drive | D3 | 12g | M5.5 | 40mm |
| | D2 | 14g | M6.3 | 50mm |
| | D1 | 20g | M8 | 50mm |
| | D54 | 20g | M8 | 55mm |



CSK Head - Self Drilling Screw 304 Stainless Steel

| Drive Type | Code | Gauge | Thread Diameter | Length |
|---|-------------|-------|-----------------|--------|
|  Square Drive | D42 | 7g | M4 | 11mm |
| | D48 | 8g | M4.2 | 19mm |
| | D30 | 10g | M4.8 | 25mm |
| | D30 (Black) | 10g | M4.8 | 25mm |
| | D31 | 10g | M4.8 | 38mm |
|  Int Hex Drive | D29 (Black) | 12g | M5.5 | 19mm |
|  Philips Drive | D26 | 12g | M5.5 | 25mm |





CSK Head - Dog Point Screw 304 Stainless Steel

| Drive Type | Code | Gauge | Thread Diameter | Length |
|--|-------------|-------|-----------------|--------|
|  Square Drive | D37 (Black) | 6g | M3.5 | 17mm |
| | D38 (Black) | 6g | M3.5 | 24mm |
| | D39 | 6g | M3.5 | 25mm |





PAN Head - Self Tapping Screw 304 Stainless Steel

| Drive Type | Code | Gauge | Thread Diameter | Length |
|---|------|-------|-----------------|--------|
|  Square Drive | D35 | 6g | M3.5 | 19mm |
| | D40 | 6g | M3.5 | 37mm |
| | D41 | 6g | M3.5 | 50mm |
| | D33 | 8g | M4.2 | 19mm |
| | D5 | 8g | M4.2 | 25mm |
| | D46 | 8g | M4.2 | 38mm |
| | D32 | 8g | M4.2 | 50mm |
| | D45 | 8g | M4.2 | 76.2mm |
| | D47 | 10g | M4.8 | 55mm |
| | D56 | 12g | M5.5 | 25mm |
|  Philips Drive | D26 | 12g | M5.5 | 25mm |



PAN Head - Self Drilling Screw 304 Stainless Steel

| Drive Type | Code | Gauge | Thread Diameter | Length |
|---|------|-------|-----------------|--------|
|  Philips Drive | D22 | 8g | M4.2 | 16mm |
| | D23 | 8g | M4.2 | 19mm |
| | D52 | 10g | M5 | 40mm |
|  Square Drive | D34 | 8g | M4.2 | 19mm |



PAN Head - Dog Point Screw 304 Stainless Steel

| Drive Type | Code | Gauge | Thread Diameter | Length |
|--|-------------|-------|-----------------|--------|
|  Square Drive | D36 | 6g | M3.5 | 19mm |
| | D43 | 6g | M4.2 | 7mm |
| | D44 (Black) | 6g | M4.2 | 7mm |
| | D60 | | M4.2 | 25mm |





CSK Head - Self Tapping Screw Steel

| Drive Type | Code | Gauge | Thread Diameter | Length |
|--|-------------|-------|-----------------|--------|
|  Square Drive | D21 | 6g | M3.5 | 16mm |
| | D20 | 7g | M4 | 28mm |
| | D19 | 7g | M4 | 32mm |
| | D18 | 7g | M4 | 38mm |
| | D17 | 7g | M4 | 50mm |
| | D16 | 7g | M4 | 65mm |
| | D14 | 10g | M5 | 88mm |
| | D15 (Black) | 10g | M5 | 88mm |



Truss Head - Self Drilling Screw 304 Stainless Steel

| Drive Type | Code | Gauge | Thread Diameter | Length |
|--|---------------------|-------|-----------------|--------|
|  Square Drive | D50 | 8g | M4.2 | 19mm |
| | D51 | 8g | M4.2 | 25mm |
|  Phillips Drive | D6 Galvanized Steel | 10g | M4.8 | 16mm |
| | D7 Galvanized Steel | 7g | M4 | 220mm |



HEX Washer Head - Self Drilling Screw 304 Stainless Steel

| Drive Type | Code | Gauge | Thread Diameter | Length |
|--|-------------|-------|-----------------|--------|
|  Washer Drive | D8 | 10g | M4.8 | 50mm |
| | D9 (Black) | 12g | M5.5 | 25mm |
| | D10 (Black) | 12g | M5.5 | 30mm |
| | D11 (Black) | 12g | M5.5 | 35mm |
| | D24 (Black) | 12g | M5.5 | 16mm |
| | D25 (Black) | 12g | M5.5 | 38mm |
| | D12 | 12g | M5.5 | 55mm |

"✓" Stocked Item
 "✱" Pre-order Only Item
 (30-40 working days delivery)



Galvanized Steel Round Tubes



| <i>Product Code</i> | <i>Ex Stock</i> | <i>O.D (mm)</i> | <i>T (mm)</i> | <i>Mass (kg/m)</i> | <i>Length (m)</i> |
|---------------------|-----------------|-----------------|---------------|--------------------|-------------------|
| RD19T1.3GALV | ✱ | 19.0 | 1.2 | 0.294 | 6.0 |
| RD20T1.5GALV | ✓ | 20.0 | 1.5 | 0.684 | 6.0 |
| RD21T2.2GALV | ✓ | 21.0 | 2.2 | 1.021 | 6.0 |
| RD25T2GALV | ✓ | 25.0 | 2.0 | 1.134 | 6.0 |
| RD25.4T1.2GALV | ✱ | 25.4 | 1.2 | 0.692 | 6.0 |
| RD26T2.2GALV | ✓ | 26.0 | 2.2 | 1.291 | 6.0 |
| RD32T2.2GALV | ✓ | 32.0 | 2.2 | 1.617 | 6.0 |
| RD48T3GALV | ✓ | 48.0 | 3.0 | 3.329 | 6.0 |
| RD60T3.5GALV | ✓ | 60.0 | 3.5 | 4.877 | 6.0 |
| RD76T3.25GALV | ✓ | 76.0 | 3.25 | 5.831 | 6.0 |
| RD114T3.25GALV | ✓ | 114.0 | 3.25 | 8.876 | 6.0 |
| RD165T3.5GALV | ✓ | 165.0 | 3.5 | 13.939 | 6.0 |

"✓" Stocked Item
 "✱" Pre-order Only Item
 (30-40 working days delivery)



Galvanized Steel Square Hollow



| Product Code | Ex Stock | A (mm) | T (mm) | R (mm) | Mass (kg/m) | Length (m) |
|------------------|----------|--------|--------|--------|-------------|------------|
| SHA20T1.5GALV | ✓ | 20.0 | 1.5 | 2.0 | 0.818 | 6.0 |
| SHA25T1.5GALV | ✓ | 25.0 | 1.5 | 2.0 | 1.080 | 6.0 |
| SHA25T2GALV | ✓ | 25.0 | 2.0 | 2.0 | 1.463 | 6.0 |
| SHA25T2.5GALV | ✱ | 25.0 | 2.5 | | 1.789 | 6.0 |
| SHA25T3GALV | ✱ | 25.0 | 3.0 | | 2.099 | 6.0 |
| SHA30T1.6GALV | ✱ | 30.0 | 1.6 | | 1.445 | 6.0 |
| SHA30T2GALV | ✓ | 30.0 | 2.0 | 2.0 | 1.789 | 6.0 |
| SHA30T2.5GALV | ✱ | 30.0 | 2.5 | | 2.099 | 6.0 |
| SHA40T1.6GALV | ✱ | 40.0 | 1.6 | | 1.954 | 6.0 |
| SHA40T2R3GALV | ✓ | 40.0 | 2.0 | 3.0 | 2.471 | 6.0 |
| SHA40T2.5R3GALV | ✓ | 40.0 | 2.5 | 3.0 | 2.981 | 6.0 |
| SHA40T3GALV | ✱ | 40.0 | 3.0 | | 3.530 | 6.0 |
| SHA40T4GALV | ✱ | 40.0 | 4.0 | | 4.579 | 6.0 |
| SHA50T1.6GALV | ✱ | 50.0 | 1.6 | | 2.463 | 6.0 |
| SHA50T2R3GALV | ✓ | 50.0 | 2.0 | 3.0 | 3.053 | 6.0 |
| SHA50T2.5GALV | ✱ | 50.0 | 2.5 | | 3.776 | 6.0 |
| SHA50T3GALV | ✱ | 50.0 | 3.0 | | 4.484 | 6.0 |
| SHA50T3R3GALV | ✓ | 50.0 | 3.0 | 3.0 | 4.423 | 6.0 |
| SHA50T4GALV | ✱ | 50.0 | 4.0 | | 5.851 | 6.0 |
| SHA50T5GALV | ✓ | 50.0 | 5.0 | | 7.155 | 6.0 |
| SHA65T1.6GALV | ✱ | 65.0 | 1.6 | | 3.226 | 6.0 |
| SHA65T2.75R3GALV | ✓ | 65.0 | 2.75 | 3.0 | 5.315 | 6.0 |
| SHA65T3GALV | ✱ | 65.0 | 3.0 | | 5.915 | 6.0 |
| SHA65T4GALV | ✱ | 65.0 | 4.0 | | 7.759 | 6.0 |
| SHA65T5GALV | ✱ | 65.0 | 5.0 | | 9.540 | 6.0 |
| SHA75T2.5GALV | ✱ | 75.0 | 2.5 | | 5.764 | 6.0 |
| SHA75T3GALV | ✱ | 75.0 | 3.0 | | 6.869 | 6.0 |
| SHA75T3R3GALV | ✓ | 75.0 | 3.0 | 3.0 | 6.808 | 6.0 |
| SHA75T4GALV | ✱ | 75.0 | 4.0 | | 9.031 | 6.0 |
| SHA75T5GALV | ✓ | 75.0 | 5.0 | | 11.130 | 6.0 |
| SHA89T3.5GALV | ✱ | 89.0 | 3.5 | | 9.516 | 6.0 |
| SHA89T5GALV | ✱ | 89.0 | 5.0 | | 13.356 | 6.0 |
| SHA89T6GALV | ✱ | 89.0 | 6.0 | | 15.836 | 6.0 |
| SHA90T3R3GALV | ✓ | 90.0 | 3.0 | 3.0 | 7.860 | 6.0 |
| SHA90T4.75GALV | ✓ | 90.0 | 4.75 | | 12.286 | 6.0 |
| SHA100T3GALV | ✱ | 100.0 | 3.0 | | 9.254 | 6.0 |
| SHA100T3R3GALV | ✓ | 100.0 | 3.0 | 3.0 | 9.193 | 6.0 |
| SHA100T4GALV | ✱ | 100.0 | 4.0 | | 12.211 | 6.0 |
| SHA100T5GALV | ✓ | 100.0 | 5.0 | | 15.105 | 6.0 |
| SHA100T6GALV | ✱ | 100.0 | 6.0 | | 17.935 | 6.0 |

"✓" Stocked Item
 "✱" Pre-order Only Item
 (30-40 working days delivery)



Galvanized Steel Rectangular Hollow



| <i>Product Code</i> | <i>Ex Stock</i> | <i>A (mm)</i> | <i>B (mm)</i> | <i>T (mm)</i> | <i>R (mm)</i> | <i>Mass (kg/m)</i> | <i>Length (m)</i> |
|---------------------|-----------------|---------------|---------------|---------------|---------------|--------------------|-------------------|
| RHA38B25T2R2GALV | ✱ | 38.0 | 25.0 | 2.0 | 2.0 | 1.764 | 6.0 |
| RHA50B25T1.6GALV | ✱ | 50.0 | 25.0 | 1.6 | | 2.128 | 6.0 |
| RHA50B25T2R2GALV | ✓ | 50.0 | 25.0 | 2.0 | 2.0 | 2.128 | 6.0 |
| RHA75B25T2R2GALV | ✱ | 75.0 | 25.0 | 2.0 | 2.0 | 2.887 | 6.0 |
| RHA100B50T3R3GALV | ✓ | 100.0 | 50.0 | 3.0 | 3.0 | 6.495 | 6.0 |
| RHA125B75T3R3GALV | ✱ | 125.0 | 75.0 | 3.0 | 3.0 | 8.770 | 6.0 |
| RHA150B50T4R4GALV | ✓ | 150.0 | 50.0 | 4.0 | 4.0 | 11.592 | 6.0 |
| RHA150B50T4R4GALV | ✱ | 150.0 | 75.0 | 4.0 | 4.0 | 13.109 | 6.0 |
| RHA200B50T4R4GALV | ✱ | 200.0 | 50.0 | 4.0 | 4.0 | 14.580 | 6.0 |
| RHA200B75T5R5GALV | ✱ | 200.0 | 75.0 | 5.0 | 5.0 | 20.655 | 6.0 |

“✓” Stocked Item
 “*” Pre-order Only Item
 (30-40 working days delivery)



Galvanized Steel Equal Angle



| Product Code | Ex Stock | A (mm) | T (mm) | Mass (kg/m) | Length (m) |
|---------------|----------|--------|--------|-------------|------------|
| EAA20T3GALV | * | 20.0 | 3.0 | 0.882 | 6.0 |
| EAA20T5GALV | * | 20.0 | 5.0 | 1.391 | 6.0 |
| EAA25T3GALV | ✓ | 25.0 | 3.0 | 1.069 | 6.0 |
| EAA25T5GALV | * | 25.0 | 5.0 | 1.789 | 6.0 |
| EAA30T3GALV | ✓ | 30.0 | 3.0 | 1.297 | 6.0 |
| EAA30T5GALV | * | 30.0 | 5.0 | 2.186 | 6.0 |
| EAA40T3GALV | ✓ | 40.0 | 3.0 | 1.836 | 6.0 |
| EAA40T5GALV | ✓ | 40.0 | 5.0 | 2.981 | 6.0 |
| EAA50T3GALV | ✓ | 50.0 | 3.0 | 2.313 | 6.0 |
| EAA50T5GALV | ✓ | 50.0 | 5.0 | 3.732 | 6.0 |
| EAA50T6GALV | * | 50.0 | 6.0 | 4.484 | 6.0 |
| EAA60T6GALV | * | 60.0 | 6.0 | 5.375 | 6.0 |
| EAA63T6GALV | ✓ | 63.0 | 6.0 | 5.658 | 6.0 |
| EAA60T8GALV | ✓ | 75.0 | 6.0 | 6.869 | 6.0 |
| EAA75T8GALV | * | 75.0 | 8.0 | 8.927 | 6.0 |
| EAA80T6GALV | ✓ | 80.0 | 6.0 | 7.346 | 6.0 |
| EAA80T8GALV | * | 80.0 | 8.0 | 9.667 | 6.0 |
| EAA80T10GALV | * | 80.0 | 10.0 | 11.925 | 6.0 |
| EAA100T6GALV | ✓ | 100.0 | 6.0 | 9.254 | 6.0 |
| EAA100T8GALV | ✓ | 100.0 | 8.0 | 12.211 | 6.0 |
| EAA100T10GALV | * | 100.0 | 10.0 | 15.105 | 6.0 |
| EAA100T12GALV | * | 100.0 | 12.0 | 17.935 | 6.0 |
| EAA125T8GALV | ✓ | 125.0 | 8.0 | 15.391 | 6.0 |

Galvanized Steel Unequal Angle



| Product Code | Ex Stock | A (mm) | B (mm) | T (mm) | Mass (kg/m) | Length (m) |
|-------------------|----------|--------|--------|--------|-------------|------------|
| UAA100B75T6GALV | ✓ | 100.0 | 75.0 | 6.0 | 12.414 | 6.0 |
| UAA125B75T10GALV | ✓ | 125.0 | 75.0 | 6.0 | 14.250 | 6.0 |
| UAA150B100T10GALV | ✓ | 150.0 | 100.0 | 10.0 | 29.381 | 6.0 |

"✓" Stocked Item
 "*" Pre-order Only Item
 (30-40 working days delivery)



Galvanized Steel Flat Bar



| Product Code | Ex Stock | A (mm) | T (mm) | Mass (kg/m) | Length (m) |
|--------------|----------|--------|--------|-------------|------------|
| FBA20T3GALV | * | 20.0 | 3.0 | 0.455 | 6.0 |
| FBA20T5GALV | * | 20.0 | 5.0 | 0.795 | 6.0 |
| FBA20T6GALV | * | 20.0 | 6.0 | 0.954 | 6.0 |
| FBA25T3GALV | ✓ | 25.0 | 3.0 | 0.569 | 6.0 |
| FBA25T5GALV | * | 25.0 | 5.0 | 0.994 | 6.0 |
| FBA25T6GALV | * | 25.0 | 6.0 | 1.193 | 6.0 |
| FBA30T3GALV | ✓ | 30.0 | 3.0 | 0.683 | 6.0 |
| FBA30T5GALV | * | 30.0 | 5.0 | 1.193 | 6.0 |
| FBA30T6GALV | * | 30.0 | 6.0 | 1.431 | 6.0 |
| FBA30T8GALV | * | 30.0 | 8.0 | 1.908 | 6.0 |
| FBA30T10GALV | * | 30.0 | 10.0 | 2.385 | 6.0 |
| FBA40T3GALV | * | 40.0 | 3.0 | 0.954 | 6.0 |
| FBA40T4GALV | ✓ | 40.0 | 4.0 | 1.214 | 6.0 |
| FBA40T5GALV | * | 40.0 | 5.0 | 1.590 | 6.0 |
| FBA50T4GALV | * | 50.0 | 4.0 | 1.517 | 6.0 |
| FBA50T5GALV | ✓ | 50.0 | 5.0 | 1.896 | 6.0 |
| FBA60T6GALV | ✓ | 60.0 | 6.0 | 2.829 | 6.0 |
| FBA80T10GALV | ✓ | 80.0 | 10.0 | 6.286 | 6.0 |
| FBA100T3GALV | * | 100.0 | 12.0 | 9.430 | 6.0 |

| ALLOY | TEMPER | Thickness (mm) | | Tensile Strength (MPa) | | | | Elongation (% min in 50mm or 5.65 √A) |
|--------|-----------------|------------------|-------|------------------------|-----|-------|-----|---|
| | | Over | Up to | Ultimate | | Yeild | | |
| | | | | Min | Max | Min | Max | |
| 1350 | -H12 | All Thicknessess | | 60 | | | | 23 |
| 2011 | -H4 | All Thicknessess | | 275 | | 125 | | 14 |
| 2011 | -T6 | - | 25.0 | 350 | | 220 | | 8 |
| | | 25.0 | 75.0 | 345 | | 220 | | 8 |
| | | 75.0 | - | 340 | | 200 | | 8 |
| 2014 | -T4 | - | 10.0 | 370 | | 240 | | 15 |
| | | 10.0 | 100.0 | 385 | | 245 | | 13 |
| | | 100.0 | 150.0 | 385 | | 245 | | 10 |
| | | 150.0 | 200.0 | 370 | | 240 | | 10 |
| 2014 | -T6 | - | 10.0 | 430 | | 385 | | 8 |
| | | 10.0 | 25.0 | 465 | | 415 | | 6 |
| | | 25.0 | 100.0 | 495 | | 450 | | 6 |
| | | 100.0 | 150.0 | 465 | | 415 | | 6 |
| 6351 | -T4 | - | 150.0 | 185 | | 115 | | 16 |
| 6351 | -T5 | All Thicknessess | | 260 | | 240 | | 8 |
| 6351 | -T54 | - | 12.5 | 205 | | 140 | | 10 |
| 6351 | -T6 | - | 150.0 | 295 | | 255 | | 8 |
| 6082 | -T4 | - | 150.0 | 190 | | 120 | | 14 |
| | | 150.0 | 200.0 | 170 | | 110 | | 11 |
| 6082 | -T5 | - | 6.0 | 270 | | 230 | | 8 |
| 6082 | -T6 | - | 20.0 | 295 | | 255 | | 7 |
| | | 20.0 | 150.0 | 310 | | 270 | | 7 |
| | | 150.0 | 200.0 | 280 | | 240 | | 5 |
| 6061 | -O _s | All Thicknessess | | 150 | | 110 | | 14 |
| 6061 | -T1 | - | 12.5 | 180 | | 95 | | 16 |
| 6061 | -T4 | All Thicknessess | | 180 | | 110 | | 14 |
| 6061 | -T42 | All Thicknessess | | 180 | | 85 | | 14 |
| 6061 | -T51 | - | 16.0 | 240 | | 205 | | 8 |
| 6061 | -T6 | All Thicknessess | | 260 | | 240 | | 8 |
| 6262 | -T6 | All Thicknessess | | 260 | | 240 | | 8 |
| 6060 | -T0 | All Thicknessess | | 130 | | | | 16 |
| 6060 | -T1 | - | 12.0 | 115 | | 60 | | 12 |
| | | 12.0 | 25.0 | 110 | | 55 | | 10 |
| 6060 | -T4 | | | 120 | | 60 | | 14 |
| 6060 | -T591 | All Thicknessess | | 120 | | 75 | | 12 |
| 6060 | -T5 | - | 12.0 | 150 | | 110 | | 6 |
| | | 12.0 | 25.0 | 145 | | 105 | | 6 |
| 6060 | -T52 | - | 12.0 | 150 | | 205 | | 8 |
| SF6060 | -T6 | | | 205 | | 170 | | 8 |
| 6063 | -O | All Thicknessess | | 130 | | | | 16 |
| 6063 | -T1 | - | 12.0 | 115 | | 60 | | 12 |
| | | 12.0 | 25.0 | 110 | | 55 | | 10 |
| 6063 | -T4 | - | 150.0 | 130 | | 70 | | 12 |
| 6063 | -T5 | - | 12.0 | 150 | | 110 | | 8 |
| | | 120.0 | 25.0 | 145 | | 105 | | 6 |
| 6063 | -T52 | - | 12.0 | 150 | | 205 | | 8 |

| ALLOY | TEMPER | Thickness (mm) | | Tensile Strength (MPa) | | | | Elongation (% min in 50mm or 5.65 √A) |
|-------|--------|-----------------|-------|------------------------|-----|-------|-----|---|
| | | Over | Up to | Ultimate | | Yield | | |
| | | | | Min | Max | Min | Max | |
| 6063 | -T6 | - | 25.0 | 205 | | 170 | | 8 |
| | | 25.0 | 150.0 | 185 | | 160 | | 10 |
| 6063 | -H112 | All Thicknesses | | 110 | | | | 13 |
| 6106 | -T4 | - | 150.0 | 130 | | 70 | | 12 |
| 6106 | -T6 | - | 10.0 | 235 | | 210 | | 8 |
| | | | 25.0 | 205 | | 170 | | 8 |
| | | 25.0 | 150.0 | 185 | | 160 | | 10 |
| 6463A | -T1 | - | 12.0 | 115 | | 60 | | 12 |
| 6463A | -T5 | - | 12.0 | 15 | | 110 | | 8 |
| 6463A | -T6 | - | 3.0 | 205 | | 170 | | 8 |
| | | 3.0 | 12.0 | 205 | | 170 | | 10 |
| 6005A | -T4 | - | 12.0 | 180 | | 110 | | 14 |
| 6005A | -T5 | All Thicknesses | | 260 | | 240 | | 8 |
| 6261 | -T1 | All Thicknesses | | 190 | | 115 | | 14 |
| 6261 | -T5 | - | 5.0 | 295 | | 255 | | 7 |
| | | 5.0 | 10.0 | 280 | | 240 | | 7 |
| 6261 | -T6 | All Thicknesses | | 295 | | 255 | | 7 |
| 7005 | -T53 | - | 20.0 | 350 | | 300 | | 10 |

| ALLOY | TEMPER | Thickness (mm) | | Tensile Strength (MPa) | | | | Elongation (% min in 50mm or 5.65 √A) |
|-------|--------|----------------|-------|------------------------|-----|-------|-----|---|
| | | Over | Up to | Ultimate | | Yield | | |
| | | | | Min | Max | Min | Max | |
| 1050 | -O | 0.15 | 0.50 | | 95 | | | 15 |
| | | 0.50 | 0.80 | | 95 | | | 20 |
| | | 0.80 | 1.30 | | 95 | | | 25 |
| | | 1.30 | 6.00 | | 95 | | | 30 |
| 1050 | -H12 | 0.25 | 0.50 | 80 | 110 | | | 4 |
| | | 0.50 | 0.80 | 80 | 110 | | | 5 |
| | | 0.80 | 1.30 | 80 | 110 | | | 6 |
| | | 1.30 | 2.60 | 80 | 110 | | | 8 |
| | | 2.60 | 6.00 | 80 | 110 | | | 12 |
| 1050 | -H14 | 0.25 | 0.30 | 100 | 125 | | | 2 |
| | | 0.30 | 0.50 | 100 | 125 | | | 3 |
| | | 0.50 | 0.80 | 100 | 125 | | | 4 |
| | | 0.80 | 1.30 | 100 | 125 | | | 5 |
| | | 1.30 | 2.60 | 100 | 125 | | | 6 |
| | | 2.60 | 12.00 | 100 | 125 | | | 8 |
| 1050 | -H16 | 0.15 | 0.50 | 115 | 140 | | | 2 |
| | | 0.50 | 0.80 | 115 | 140 | | | 3 |
| | | 0.80 | 1.30 | 115 | 140 | | | 4 |
| | | 1.30 | 4.00 | 115 | 140 | | | 5 |
| 1050 | -H18 | 0.15 | 0.50 | 130 | | | | 1 |
| | | 0.50 | 0.80 | 130 | | | | 2 |
| | | 0.80 | 1.30 | 130 | | | | 3 |
| | | 1.30 | 1.60 | 130 | | | | 4 |
| | | 1.60 | 3.25 | 130 | | | | 5 |
| 1050 | -H112 | 6.00 | 25.00 | 60 | | | | 30 |
| 1100 | -O | 0.15 | 0.50 | 75 | 105 | 25 | | 15 |
| | | 0.50 | 0.80 | 75 | 105 | 25 | | 20 |
| | | 0.80 | 1.30 | 75 | 105 | 25 | | 25 |
| | | 1.30 | 6.00 | 75 | 105 | 25 | | 30 |
| | | 6.00 | 75.00 | 75 | 105 | 25 | | 26 |
| 1100 | -H12 | 0.40 | 0.50 | 95 | 130 | 75 | | 3 |
| | | 0.50 | 0.80 | 95 | 130 | 75 | | 4 |
| | | 0.80 | 1.30 | 95 | 130 | 75 | | 6 |
| | | 1.30 | 3.00 | 95 | 130 | 75 | | 8 |
| | | 3.00 | 6.00 | 95 | 130 | 75 | | 9 |
| | | 6.00 | 12.00 | 95 | 130 | 75 | | 9 |
| 12.00 | 50.00 | 95 | 130 | 75 | | 10 | | |
| 1100 | -H14 | 0.25 | 0.30 | 110 | 145 | | | 1 |
| | | 0.30 | 0.50 | 110 | 145 | 95 | | 2 |
| | | 0.50 | 0.80 | 110 | 145 | 95 | | 3 |
| | | 0.80 | 1.30 | 110 | 145 | 95 | | 4 |
| | | 1.30 | 3.00 | 110 | 145 | 95 | | 5 |
| | | 3.00 | 6.00 | 110 | 145 | 95 | | 6 |
| | | 6.00 | 12.00 | 110 | 145 | 95 | | 6 |
| | | 12.00 | 25.00 | 110 | 145 | 95 | | 8 |

| ALLOY | TEMPER | Thickness (mm) | | Tensile Strength (MPa) | | | | Elongation (% min in 50mm or 5.65 √A) |
|-------|--------|----------------|-------|------------------------|-----|-------|-----|---|
| | | Over | Up to | Ultimate | | Yeild | | |
| | | | | Min | Max | Min | Max | |
| 1100 | -H16 | 0.15 | 0.50 | 130 | 165 | 115 | | 1 |
| | | 0.50 | 0.80 | 130 | 165 | 115 | | 2 |
| | | 0.80 | 1.30 | 130 | 165 | 115 | | 3 |
| | | 1.30 | 4.00 | 130 | 165 | 115 | | 4 |
| 1100 | -H18 | 0.15 | 0.50 | 150 | | | | 1 |
| | | 0.50 | 0.80 | 150 | | | | 2 |
| | | 0.80 | 1.30 | 150 | | | | 3 |
| | | 1.30 | 3.25 | 150 | | | | 4 |
| 1100 | -H112 | 6.00 | 12.00 | 90 | | 50 | | 9 |
| | | 12.00 | 50.00 | 85 | | 35 | | 13 |
| | | 50.00 | 75.00 | 80 | | 30 | | 18 |
| 1200 | -O | 0.15 | 0.50 | | 105 | 25 | | 15 |
| | | 0.50 | 0.80 | | 105 | 25 | | 20 |
| | | 0.80 | 1.30 | | 105 | 25 | | 25 |
| | | 1.30 | 6.00 | | 105 | 25 | | 30 |
| | | 6.00 | 75.00 | 75 | 105 | 25 | | 26 |
| 1200 | -H12 | 0.40 | 0.50 | 95 | 130 | 75 | | 3 |
| | | 0.50 | 0.80 | 95 | 130 | 75 | | 4 |
| | | 0.80 | 1.30 | 95 | 130 | 75 | | 6 |
| | | 3.00 | 1.30 | 95 | 130 | 75 | | 8 |
| | | 6.00 | 3.00 | 95 | 130 | 75 | | 9 |
| | | 12.00 | 6.00 | 95 | 130 | 75 | | 9 |
| | | 50.00 | 12.00 | 95 | 130 | 75 | | 10 |
| 1200 | -H14 | 0.25 | 0.30 | 110 | 145 | | | 1 |
| | | 0.30 | 0.50 | 110 | 145 | 95 | | 2 |
| | | 0.50 | 0.80 | 110 | 145 | 95 | | 3 |
| | | 0.80 | 1.30 | 110 | 145 | 95 | | 4 |
| | | 3.00 | 3.00 | 110 | 145 | 95 | | 5 |
| | | 6.00 | 6.00 | 110 | 145 | 95 | | 6 |
| | | 12.00 | 12.00 | 110 | 145 | 95 | | 6 |
| | | 25.00 | 25.00 | 110 | 145 | 95 | | 8 |
| 1200 | -H16 | 15.00 | 0.50 | 130 | 165 | 115 | | 1 |
| | | 0.50 | 0.80 | 130 | 165 | 115 | | 2 |
| | | 0.80 | 1.30 | 130 | 165 | 115 | | 3 |
| | | 1.30 | 4.00 | 130 | 165 | 115 | | 4 |
| 1200 | -H18 | 0.15 | 0.50 | 150 | | | | 1 |
| | | 0.50 | 0.80 | 150 | | | | 2 |
| | | 0.80 | 1.30 | 150 | | | | 3 |
| | | 1.30 | 3.25 | 150 | | | | 4 |
| 1200 | -H112 | 6.00 | 12.00 | 90 | | 50 | | 9 |
| | | 12.00 | 50.00 | 85 | | 35 | | 12 |
| | | 50.00 | 75.00 | 80 | | 30 | | 18 |
| 3003 | -O | 0.15 | 0.20 | 95 | 130 | | | 14 |
| | | 0.20 | 0.30 | 95 | 130 | | | 18 |
| | | 0.30 | 0.80 | 95 | 130 | 35 | | 20 |
| | | 0.80 | 1.30 | 95 | 130 | 35 | | 23 |
| | | 1.30 | 6.00 | 95 | 130 | 35 | | 25 |
| | | 6.00 | 75.00 | 95 | 130 | 35 | | 21 |

| ALLOY | TEMPER | Thickness (mm) | | Tensile Strength (MPa) | | | | Elongation (% min in 50mm or 5.65 √A) |
|-------|--------|----------------|-------|------------------------|-----|-------|-----|---|
| | | Over | Up to | Ultimate | | Yield | | |
| | | | | Min | Max | Min | Max | |
| 3003 | -H12 | 0.40 | 0.50 | 115 | 160 | 80 | | 3 |
| | | 0.50 | 0.80 | 115 | 160 | 80 | | 4 |
| | | 0.80 | 1.30 | 115 | 160 | 80 | | 5 |
| | | 1.30 | 3.00 | 115 | 160 | 80 | | 6 |
| | | 3.00 | 4.00 | 115 | 160 | 80 | | 7 |
| | | 4.00 | 6.00 | 115 | 160 | 80 | | 8 |
| | | 6.00 | 12.00 | 115 | 160 | 80 | | 9 |
| | | 12.00 | 50.00 | 115 | 160 | 80 | | 8 |
| 3003 | -H14 | 0.25 | 0.30 | 135 | 180 | 115 | | 1 |
| | | 0.30 | 0.50 | 135 | 180 | 115 | | 2 |
| | | 0.50 | 0.80 | 135 | 180 | 115 | | 3 |
| | | 0.80 | 1.30 | 135 | 180 | 115 | | 4 |
| | | 1.30 | 3.00 | 135 | 180 | 115 | | 5 |
| | | 3.00 | 4.00 | 135 | 180 | 115 | | 6 |
| | | 4.00 | 6.00 | 135 | 180 | 115 | | 7 |
| | | 6.00 | 12.00 | 135 | 180 | 115 | | 8 |
| 3003 | -H16 | 0.15 | 0.50 | 165 | 205 | 145 | | 1 |
| | | 0.50 | 0.80 | 165 | 205 | 145 | | 2 |
| | | 0.80 | 1.30 | 165 | 205 | 145 | | 3 |
| | | 1.30 | 4.00 | 165 | 205 | 145 | | 4 |
| 3003 | -H18 | 0.15 | 0.50 | 185 | | 165 | | 1 |
| | | 0.50 | 0.80 | 185 | | 165 | | 2 |
| | | 0.80 | 1.30 | 185 | | 165 | | 3 |
| | | 1.30 | 3.25 | 185 | | 165 | | 4 |
| 3003 | -H112 | 6.00 | 12.00 | 115 | | 70 | | 8 |
| | | 12.00 | 50.00 | 105 | | 40 | | 10 |
| | | 50.00 | 75.00 | 100 | | 40 | | 16 |
| 5005 | -O | 0.15 | 0.20 | 105 | 145 | | | 12 |
| | | 0.20 | 0.30 | 105 | 145 | | | 14 |
| | | 0.30 | 0.50 | 105 | 145 | 35 | | 16 |
| | | 0.50 | 0.80 | 105 | 145 | 35 | | 18 |
| | | 0.80 | 1.30 | 105 | 145 | 35 | | 20 |
| | | 1.30 | 3.00 | 105 | 145 | 35 | | 21 |
| | | 3.00 | 6.00 | 105 | 145 | 35 | | 22 |
| 5005 | -H12 | 0.40 | 0.50 | 125 | 165 | 95 | | 2 |
| | | 0.50 | 0.80 | 125 | 165 | 95 | | 3 |
| | | 0.80 | 1.30 | 125 | 165 | 95 | | 4 |
| | | 1.30 | 3.00 | 125 | 165 | 95 | | 6 |
| | | 3.00 | 4.00 | 125 | 165 | 95 | | 7 |
| | | 4.00 | 6.00 | 125 | 165 | 95 | | 8 |
| 5005 | -H14 | 0.25 | 0.80 | 145 | 185 | 115 | | 1 |
| | | 0.80 | 1.30 | 145 | 185 | 115 | | 2 |
| | | 1.30 | 3.00 | 145 | 185 | 115 | | 3 |
| | | 3.00 | 4.00 | 145 | 185 | 115 | | 5 |
| | | 4.00 | 6.00 | 145 | 185 | 115 | | 6 |

| ALLOY | TEMPER | Thickness (mm) | | Tensile Strength (MPa) | | | | Elongation (% min in 50mm or 5.65 √A) |
|-------|--------|----------------|-------|------------------------|-----|-------|-----|---|
| | | Over | Up to | Ultimate | | Yeild | | |
| | | | | Min | Max | Min | Max | |
| 5005 | -H16 | 0.15 | 0.80 | 165 | 205 | 135 | | 1 |
| | | 0.80 | 1.30 | 165 | 205 | 135 | | 2 |
| | | 1.30 | 4.00 | 165 | 205 | 135 | | 3 |
| 5005 | -H18 | 0.15 | 0.80 | 185 | | | | 1 |
| | | 0.80 | 1.30 | 185 | | | | 2 |
| | | 1.30 | 3.25 | 185 | | | | 3 |
| 5005 | -H19 | 0.15 | 1.00 | 195 | | | | 1 |
| 5005 | -H32 | 0.40 | 0.50 | 115 | 160 | 85 | | 3 |
| | | 0.50 | 0.80 | 115 | 160 | 85 | | 4 |
| | | 0.80 | 1.30 | 115 | 160 | 85 | | 5 |
| | | 1.30 | 3.00 | 115 | 160 | 85 | | 7 |
| | | 3.00 | 4.00 | 115 | 160 | 85 | | 8 |
| | | 4.00 | 6.00 | 115 | 160 | 85 | | 9 |
| 5005 | -H34 | 0.25 | 0.30 | 135 | 180 | | | 2 |
| | | 0.30 | 0.80 | 135 | 180 | 105 | | 3 |
| | | 0.80 | 1.30 | 135 | 180 | 105 | | 4 |
| | | 1.30 | 3.00 | 135 | 180 | 105 | | 5 |
| | | 3.00 | 4.00 | 135 | 180 | 105 | | 6 |
| | | 4.00 | 6.00 | 135 | 180 | 105 | | 7 |
| 5005 | -H36 | | | | 180 | | 165 | 6 |
| 5005 | -H38 | 0.15 | 0.30 | 180 | | | | 1 |
| | | 0.30 | 0.50 | 180 | | | | 2 |
| | | 0.50 | 0.80 | 180 | | | | 3 |
| | | 0.80 | 3.25 | 180 | | | | 4 |
| 5005 | -O | 0.15 | 0.20 | 170 | 215 | | | - |
| | | 0.20 | 0.30 | 170 | 215 | | | 14 |
| | | 0.30 | 0.50 | 170 | 215 | 65 | | 15 |
| | | 0.50 | 0.80 | 170 | 215 | 65 | | 16 |
| | | 0.80 | 1.30 | 170 | 215 | 65 | | 18 |
| | | 1.30 | 3.00 | 170 | 215 | 65 | | 19 |
| | | 3.00 | 6.00 | 170 | 215 | 65 | | 20 |
| | | 6.00 | 75.00 | 170 | 215 | 65 | | 16 |
| 5052 | -H32 | 0.40 | 0.50 | 215 | 265 | 160 | | 4 |
| | | 0.50 | 1.30 | 215 | 265 | 160 | | 5 |
| | | 1.30 | 3.00 | 215 | 265 | 160 | | 7 |
| | | 3.00 | 6.00 | 215 | 265 | 160 | | 9 |
| | | 6.00 | 12.00 | 215 | 265 | 160 | | 11 |
| | | 12.00 | 50.00 | 215 | 265 | 160 | | 10 |
| 5052 | -H34 | 0.25 | 0.50 | 235 | 285 | 180 | | 3 |
| | | 0.50 | 1.30 | 235 | 285 | 180 | | 4 |
| | | 1.30 | 3.00 | 235 | 285 | 180 | | 6 |
| | | 3.00 | 6.00 | 235 | 285 | 180 | | 7 |
| | | 6.00 | 25.00 | 235 | 285 | 180 | | 8 |
| 5052 | -H36 | 0.15 | 0.20 | 255 | 305 | | | 2 |
| | | 0.20 | 0.80 | 255 | 305 | 200 | | 3 |
| | | 0.80 | 4.00 | 255 | 305 | 200 | | 4 |

| ALLOY | TEMPER | Thickness (mm) | | Tensile Strength (MPa) | | | | Elongation (% min in 50mm or 5.65 √A) |
|-------|--|----------------|-------|------------------------|-----|-------|-----|---|
| | | Over | Up to | Ultimate | | Yeild | | |
| | | | | Min | Max | Min | Max | |
| 5052 | -H38 | 0.15 | 0.20 | 270 | | | | 2 |
| | | 0.20 | 0.80 | 270 | | 220 | | 3 |
| | | 0.80 | 3.25 | 270 | | 220 | | 4 |
| 5052 | -H391 | 0.15 | 2.00 | 290 | | 240 | | 3 |
| 5052 | -H112 | 6.00 | 12.00 | 195 | | 110 | | 7 |
| | | 12.00 | 50.00 | 170 | | 65 | | 10 |
| | | 50.00 | 75.00 | 170 | | 65 | | 14 |
| 5251 | Mechanical properties are almost identical to 5052 | | | | | | | |
| 5454 | -O | 0.50 | 0.80 | 215 | 285 | 80 | | 12 |
| | | 0.80 | 1.30 | 215 | 285 | 80 | | 14 |
| | | 1.30 | 3.00 | 215 | 285 | 80 | | 16 |
| | | 3.00 | 75.00 | 215 | 285 | 80 | | 16 |
| 5454 | -H32 | 0.50 | 1.30 | 250 | 305 | 180 | | 5 |
| | | 1.30 | 6.00 | 250 | 305 | 180 | | 8 |
| | | 6.00 | 50.00 | 250 | 305 | 180 | | 10 |
| 5454 | -H34 | 0.50 | 1.30 | 270 | 325 | 200 | | 4 |
| | | 1.30 | 4.00 | 270 | 325 | 200 | | 6 |
| | | 4.00 | 6.00 | 270 | 325 | 200 | | 7 |
| | | 6.00 | 25.00 | 270 | 325 | 200 | | 8 |
| 5454 | -H112 | 6.00 | 12.00 | 220 | | 125 | | 8 |
| | | 12.00 | 50.00 | 215 | | 80 | | 9 |
| | | 50.00 | 75.00 | 215 | | 80 | | 13 |
| 5083 | -O | 1.30 | 40.00 | 275 | 350 | 125 | 200 | 14 |
| | | 40.00 | 75.00 | 270 | 345 | 115 | 200 | 14 |
| 5083 | -H111 | 6.00 | 40.00 | 290 | 350 | 170 | 285 | 12 |
| 5083 | -H121 | 6.00 | 50.00 | 305 | 385 | 215 | 295 | 10 |
| 5083 | -H311 | 6.00 | 40.00 | 290 | 350 | 170 | 285 | 14 |
| 5083 | -H321 | 5.00 | 40.00 | 305 | 385 | 215 | 295 | 10 |
| | | 40.00 | 75.00 | 280 | 385 | 200 | 295 | 10 |
| 5083 | -H323 | 1.30 | 3.20 | 310 | 375 | 235 | 305 | 8 |
| | | 3.20 | 6.00 | 310 | 375 | 235 | 305 | 10 |
| 5083 | -H343 | 1.30 | 3.20 | 345 | 405 | 270 | 340 | 6 |
| | | 3.20 | 6.00 | 345 | 405 | 270 | 340 | 8 |
| 5083 | -H112 | 6.00 | 40.00 | 275 | | 125 | | 10 |
| | | 40.00 | 75.00 | 270 | | 115 | | 10 |
| 5083 | -H115 | 20.00 | 50.00 | 310 | | 255 | | 7 |
| | | 50.00 | 70.00 | 305 | | 240 | | 7 |
| 5083 | -H116 | 3.00 | 6.00 | 305 | | 215 | | 10 |
| | | 6.00 | 30.00 | 305 | | 215 | | 10 |
| 6061 | -O | 0.25 | 0.50 | 150 | | 85 | | 14 |
| | | 0.50 | 3.25 | 150 | | 85 | | 16 |
| | | 3.25 | 12.00 | 150 | | 85 | | 18 |
| | | 12.00 | 25.00 | 150 | | | | 16 |
| 6061 | -T4 | 0.25 | 0.50 | 205 | | 115 | | 14 |
| | | 0.50 | 6.00 | 205 | | 115 | | 16 |
| | | 6.00 | 25.00 | 205 | | 115 | | 16 |

| ALLOY | TEMPER | Thickness (mm) | | Tensile Strength (MPa) | | | | Elongation (% min in 50mm or 5.65 √A) |
|-------|----------|----------------|-------|------------------------|-----|-------|-----|---|
| | | Over | Up to | Ultimate | | Yeild | | |
| | | | | Min | Max | Min | Max | |
| 6061 | -T42 | 0.25 | 0.50 | 205 | | 95 | | 14 |
| | | 0.50 | 6.00 | 205 | | 95 | | 16 |
| | | 6.00 | 25.00 | 205 | | 95 | | 16 |
| 6061 | -T6 & 62 | 0.25 | 0.50 | 290 | | 240 | | 8 |
| | | 0.50 | 12.00 | 290 | | 240 | | 10 |
| | | 12.00 | 25.00 | 290 | | 240 | | 7 |
| 7075 | -T6 & 62 | | | 570 | | 505 | | 11 |
| 8011 | -O | 0.15 | 0.30 | 75 | 105 | | | 16 |
| | | 0.30 | 0.80 | 75 | 105 | | | 20 |
| | | 0.80 | 1.30 | 75 | 105 | | | 25 |
| | | 1.30 | 5.00 | 75 | 105 | | | 30 |
| 8011 | -H12 | 0.20 | 0.50 | 100 | 135 | | | 3 |
| | | 0.50 | 0.80 | 100 | 135 | | | 4 |
| | | 0.80 | 1.30 | 100 | 135 | | | 6 |
| | | 1.30 | 3.00 | 100 | 135 | | | 8 |
| | | 3.00 | 6.00 | 100 | 135 | | | 9 |
| 8011 | -H14 | 0.20 | 0.50 | 115 | 150 | | | 2 |
| | | 0.50 | 0.80 | 115 | 150 | | | 3 |
| | | 0.80 | 1.30 | 115 | 150 | | | 4 |
| | | 1.30 | 3.00 | 115 | 150 | | | 5 |
| | | 3.00 | 6.00 | 115 | 150 | | | 7 |
| 8011 | -H16 | 0.20 | 0.50 | 140 | 170 | | | 1 |
| | | 0.50 | 0.80 | 140 | 170 | | | 2 |
| | | 0.80 | 1.30 | 140 | 170 | | | 3 |
| | | 1.30 | 3.00 | 140 | 170 | | | 4 |
| | | 3.00 | 6.00 | 140 | 170 | | | 5 |
| 8011 | -H18 | 0.20 | 0.50 | 160 | | | | 1 |
| | | 0.50 | 0.80 | 160 | | | | 2 |
| | | 0.80 | 1.30 | 160 | | | | 3 |
| | | 1.30 | 3.00 | 160 | | | | 4 |

*Elevate Your Designs
with Our Aluminum Excellence*



*Crafted with **meticulous precision**
Our Aluminum Extrusions guarantee **seamless performance**
Setting a new standard in **quality & reliability** for your diverse applications*



SD
ALUMINIUM

Contact Us Now!



Auckland Rosedale Branch

Address: 6 John Glenn Ave, Rosedale, Auckland 0632

Phone: 09-218 2188, 09-218 2111

Email: info@sdaluminium.co.nz

Auckland Manukau Branch

Address: 28 Ryan Place, Manukau City, Auckland 2104

Phone: 09-217 8666

Email: info@sdaluminium.co.nz

 <https://www.linkedin.com/company/67363257/admin/feed/posts/>

 <https://www.linkedin.com/company/67363257/admin/feed/posts/>

 <https://www.facebook.com/SDAluminiumLtd>

Follow Us on Social Media