



SD Aluminium Comprehensive Product Catalogue



*A wide range of selections and high-quality materials
All supported by extensive local stock.*

May 2024 Edition



Your premier source for
top-quality standard aluminium extrusions & sheets
with expertise in tailor-made custom extrusions as well

Auckland Rosedale Branch

Address: 6 John Glenn Ave, Rosedale, Auckland 0632

Phone: 09-218 2188, 09-218 2111

Email: info@sdalu.co.nz

Auckland Manukau Branch

Address: 26 Lambie Dr, Papatoetoe, Auckland 2104

Phone: 09-218 2188, 09-218 2111

Email: info@sdalu.co.nz



About Us ...

SD Aluminium Ltd is a 100% New Zealand owned company. Founded in Albany, Auckland, with over 20 years' experiences in manufacturing and trading, SD Aluminium manufactures, produces and distributes premium aluminium extrusions, aluminium doors as well as customized aluminium extrusions, finishes, and fabrication coatings.

Their highly-skilled team has worked on a range of projects in many different industries, covering everything from aluminium extrusions for windows, doors, gates and fences, through to greenhouses, glass support, scaffolding and industrial assembly lines.

With their sophisticated production equipment, strong technical forces, advanced production management system and commitment to perfect customer service, you can trust them to deliver the highest quality solutions at competitive prices.

Business Advantage

01 Locally Based

SD Aluminium LTD is based right here in Auckland, New Zealand. They know the local market inside out and are only a phone call away.

02 Specialist design support

SD Aluminium's team of highly experienced engineers can assist with every stage of your project, from design and prototyping, through to production and installation.

03 Extensive Inventory

SD Aluminium provide a wide range of aluminium products, resulting in a large inventory with hundreds of different kinds suited for projects in the construction, marine and transport industries and more.

04 Fast Delivery

With our own delivery team, we can quick respond for your order request. From choosing and packaging you just need to call us and we will deliver your shipment as soon as possible.

Aluminium

Geometric Shape & Standard Profiles



<i>Square Hollows</i>	_____	1 - 4
<i>Rectangular Hollows</i>	_____	5 - 10
<i>Round Tubes</i>	_____	11 - 25
<i>Equal Angles</i>	_____	26 - 27
<i>Unequal Angles</i>	_____	28 - 30
<i>U Channels</i>	_____	31 - 34
<i>Flat Bars</i>	_____	35 - 39
<i>Tee Bars</i>	_____	40
<i>Solid Rod</i>	_____	41 - 42
<i>Solid Square</i>	_____	43
<i>Flat Sheet</i>	_____	44 - 45
<i>Plate & Panel</i>	_____	46
<i>Powdercoated Profiles</i>	_____	47 - 49
<i>Fence Systems</i>	_____	50 - 54
<i>Pre-punched Extrusions</i>	_____	55 - 59
<i>Louvre Systems</i>	_____	60 - 62
<i>Canopy Systems</i>	_____	63 - 68
<i>Wardrobe & Kitchen Systems</i>	_____	69 - 70
<i>Security Systems</i>	_____	71 - 72
<i>Window & Door Systems</i>	_____	73 - 76
<i>T-Slot Systems</i>	_____	77 - 80
<i>Mouldings & Tracks</i>	_____	81
<i>Y-Posts & Farm Fences</i>	_____	82
<i>Temporary Fence Systems</i>	_____	83
<i>Accessories</i>	_____	84
<i>Screws</i>	_____	85 - 87
<i>Galvanised Steel Extrusions</i>	_____	88 - 92
<i>Technical Data Sheet</i>	_____	93 - 100



"✓" Stocked Item
 "✱" Pre-order Only Item
 (30-40 working days delivery)



Square Hollow

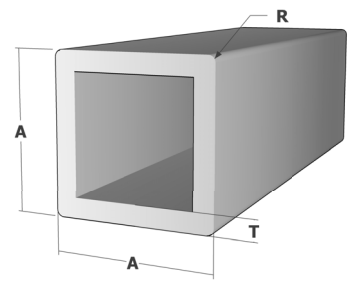

Product Code	Ex Stock	A (mm)	T (mm)	R (mm)	Mass (kg/m)	Perimeter (mm)	Area (mm ²)
SHA10T1	✱	10.0	1.0		0.103	40.00	36.00
SHA12T1	✓	12.0	1.0		0.125	48.00	44.00
SHA15T1	✱	15.0	1.0		0.160	60.00	56.00
SHRA15T1R1.5	✱	15.0	1.0	1.5	0.150	55.83	52.49
SHA15T1.2	✱	15.0	1.2		0.189	60.00	66.24
SHA15T1.5	✓	15.0	1.5		0.231	60.00	81.14
SHA16T1.3	✓	16.0	1.3		0.218	64.00	76.44
SHRA16T1.8R2.8	✱	16.0	1.8	2.8	0.314	58.85	110.00
SHA18T1.2	✱	18.0	1.2		0.230	72.00	80.64
SHA18T2.2	✓	18.0	2.2		0.396	72.00	139.00
SHRA18.7T1.3R6	✱	18.7	1.3	6.0	0.224	64.50	78.54
SHRA18.8T1.35R6	✱	18.8	1.35	6.0	0.233	64.90	81.89
SHA19T0.8	✱	19.0	0.8		0.166	76.00	58.40
SHA19T1	✱	19.0	1.0		0.205	76.00	72.00
SHA19T1.2	✓	19.0	1.2		0.244	76.00	85.44
SHRA19T1.2R2	✓	19.0	1.2	2.0	0.235	72.57	82.56
SHA19T1.6	✓	19.0	1.6		0.317	75.14	113.36
SHRA19T1.6R2	✓	19.0	1.6	2.0	0.317	72.60	108.14
SHRA19T2R2	✓	19.0	2.0	2.0	0.378	72.60	132.64
SHA20T0.55	✱	20.0	0.55		0.122	80.00	42.79
SHA20T0.7	✱	20.0	0.7		0.154	80.00	54.00
SHA20T1.2	✓	20.0	1.2		0.257	80.00	90.24
SHRA20T1.6R2	✱	20.0	1.6	2.0	0.326	76.57	114.46
SHRA20T1.8R2	✱	20.0	1.8	2.0	0.364	76.57	127.70
SHRA20T1.9R1	✱	20.0	1.9	1.0	0.390	78.28	136.80
SHA20T2	✓	20.0	2.0		0.410	80.00	144.00
SHA20T3	✓	20.0	3.0		0.581	79.49	204.00
SHRA21T1.8R2.8	✱	21.0	1.8	2.8	0.418	79.30	146.52
SHA22T0.75	✱	22.0	0.75		0.182	87.00	63.75
SHRA22T1.1	✱	22.0	1.1		0.262	87.50	91.96
SHRA23T2R2.5	✱	23.0	2.0	2.5	0.464	87.70	162.71
SHRA23.8T10.9R1	✱	23.8	10.9	1.0	0.186	6.54	65.40
SHA24.8T1.5	✱	24.8	1.5		0.398	98.69	139.80
SHA24.8T1.8	✱	24.8	1.8		0.472	98.68	165.60
SHA25T0.6	✱	25.0	0.6		0.167	99.49	58.56
SHA25T0.8	✱	25.0	0.8		0.207	99.49	72.67
SHA25T1	✱	25.0	1.0		0.274	99.50	96.00
SHA25T1.2	✓	25.0	1.2		0.326	100.00	114.24
SHRA25T1.2R2	✓	25.0	1.2	2.0	0.317	96.57	111.36
SHA25T1.5	✱	25.0	1.5		0.402	100.00	141.00

"✓" Stocked Item
 "✱" Pre-order Only Item
 (30-40 working days delivery)



Square Hollow

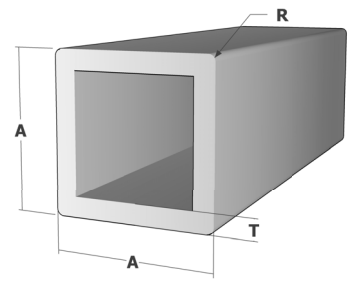

Product Code	Ex Stock	A (mm)	T (mm)	R (mm)	Mass (kg/m)	Perimeter (mm)	Area (mm ²)
SHRA25T1.5R2	✓	25.0	1.5	2.0	0.393	96.60	137.80
SHRA25T1.8R2	✱	25.0	1.8	2.0	0.463	95.80	162.30
SHA25T2	✓	25.0	2.0		0.524	100.00	184.00
SHRA25T2R2	✱	25.0	2.0	2.0	0.510	95.76	179.00
SHRA25T2R3	✓	25.0	2.0	3.0	0.505	94.85	177.13
SHRA25T2.5R2	✱	25.0	2.5	2.0	0.626	95.76	219.60
SHRA25T3R3	✓	25.0	3.0	3.0	0.731	94.85	256.35
SHA25T3	✓	25.0	3.0		0.752	100.00	264.00
SHA25.4T0.9	✱	25.4	0.9		0.251	101.10	88.20
SHA28T2	✱	28.0	2.0		0.593	111.50	207.92
SHRA28.5T1.8R2.5	✱	28.5	1.8	2.5	0.533	109.70	187.10
SHA29.5T0.65	✱	29.5	0.65		0.214	118.00	75.00
SHA29.5T1.75	✱	29.5	1.75		0.554	119.14	194.25
SHA30T0.8	✱	30.0	0.8		0.299	120.00	104.76
SHRA30T1.5R1.5	✓	30.0	1.5	1.5	0.482	117.42	169.14
SHA30T1.9	✱	30.0	1.9		0.609	119.50	213.56
SHRA30T2R2	✱	30.0	2.0	2.0	0.629	116.57	220.64
SHRA30T2R3	✓	30.0	2.0	3.0	0.619	114.85	217.13
SHA30T3	✓	30.0	3.0		0.923	119.50	324.00
SHA31.8T0.9	✱	31.8	0.9		0.317	126.50	111.10
SHRA32T1.2R3	✓	32.0	1.2	3.0	0.407	122.85	142.90
SHRA32T2.3R3.5	✱	32.0	2.3	3.5	0.759	121.99	266.16
SHA32T3	✓	32.0	3.0		0.992	128.00	348.00
SHRA32.1T1.45R3	✱	32.1	1.45	3.0	0.491	123.34	172.23
SHRA33T3R5	✱	33.0	3.0	5.0	0.975	123.42	341.97
SHRA34T1.6R3	✓	34.0	1.6	3.0	0.574	130.85	201.32
SHA35T1	✱	35.0	1.0		0.388	140.00	136.00
SHRA35T1.6R1.5	✱	35.0	1.6	1.5	0.605	137.40	212.30
SHA35T1.75	✱	35.0	1.75		0.663	139.14	232.75
SHRA35T2R2	✱	35.0	2.0	2.0	0.743	136.57	260.64
SHA35T2	✱	35.0	3.0		0.752	140.00	264.00
SHA35T3	✱	35.0	3.0		1.094	140.00	384.00
SHRA36T1.5R1	✱	36.0	1.5	1.0	0.588	142.30	206.40
SHA38T0.6	✱	38.0	0.6		0.256	152.00	89.80
SHA38T1	✱	38.0	1.0		0.422	151.50	148.00
SHA38T0.9	✱	38.0	0.9		0.382	151.90	133.92
SHA38T1.3	✱	38.0	1.3		0.544	151.50	190.84
SHA39T0.8	✱	39.0	0.8		0.348	156.00	122.24
SHA39.5T0.8	✱	39.5	0.8		0.353	157.50	123.90
SHA40T0.8	✱	40.0	0.8		0.358	160.00	125.44

"✓" Stocked Item
 "✱" Pre-order Only Item
 (30-40 working days delivery)



Square Hollow

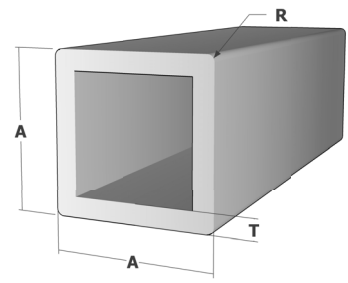

Product Code	Ex Stock	A (mm)	T (mm)	R (mm)	Mass (kg/m)	Perimeter (mm)	Area (mm ²)
SHA40T1.2	✱	40.0	1.2		0.531	160.00	186.24
SHA40T1.5	✱	40.0	1.5		0.658	160.00	230.92
GM-PF-23	✱	40.0	2.0	3.5	0.842	154.00	295.40
SHA40T2	✓	40.0	2.0		0.866	160.00	304.00
SHRA40T2R3	✓	40.0	2.0	3.0	0.847	154.85	297.13
SHRA40T2.5R3.5	✱	40.0	2.5	3.5	1.041	154.00	365.30
SHA40T3	✓	40.0	3.0		1.265	160.00	444.00
SHRA40T3R3	✓	40.0	3.0	3.0	1.243	154.85	436.27
SHA40T4	✓	40.0	4.0		1.642	160.00	576.00
SHA44.5T0.9	✱	44.5	0.9		0.447	117.30	156.78
SHA45T0.6	✱	45.0	0.6		0.304	180.00	106.56
SHA45T0.8	✱	45.0	0.8		0.378	179.49	132.67
SHRA45T1.6R2	✱	45.0	1.6	2.0	0.783	176.60	274.60
SHRA45T2R3.5	✱	45.0	2.0	3.5	0.960	174.00	335.42
SHA50T0.8	✱	50.0	0.8		0.449	199.50	157.44
SHA50T1.0	✱	50.0	1.0		0.559	199.50	196.00
SHA50T1.2	✓	50.0	1.2		0.667	199.50	234.20
SHA50T1.4	✱	50.0	1.4		0.776	200.00	272.16
SHA50T2.0	✓	50.0	2.0		1.094	200.00	384.00
SHRA50T2.0R3	✓	50.0	2.0	3.0	1.075	194.85	377.13
SHA50T2.5	✱	50.0	2.5		1.356	200.00	475.86
SHA50T3	✓	50.0	3.0		1.607	200.00	564.00
SHRA50T3R3	✓	50.0	3.0	3.0	1.585	194.85	556.28
SHA50T3.5	✱	50.0	3.5		1.855	200.00	650.86
SHA50T4	✓	50.0	4.0		2.098	200.00	736.00
SHA50T5	✓	50.0	5.0		2.565	200.00	900.00
SHA60T1.5	✱	60.0	1.5		1.000	239.50	351.00
SHA60T2	✱	60.0	2.0		1.322	240.00	464.00
SHRA60T2R3.5	✱	60.0	2.0	3.5	1.298	221.43	455.42
SHA60T2.5	✓	60.0	2.5		1.639	240.00	575.00
SHRA60T2.7R3.5	✱	60.0	2.7	3.5	1.735	234.00	608.90
SHA60T6	✱	60.0	6.0		3.694	240.00	1296.00
SHRA65T2.5R3	✓	65.0	2.5	3.0	1.760	254.85	617.49
SHRA70T4	✱	70.0	4.0		3.010	280.00	1056.00
SHA75T1.6	✓	75.0	1.6		1.339	299.20	469.80
SHA75T3.0	✓	75.0	3.0		2.462	299.50	864.00
SHRA75T3R3	✓	75.0	3.0	3.0	2.440	294.85	856.27
SHA75T4	✓	75.0	4.0		3.238	299.50	1136.00
SHA80T1.5	✱	80.0	1.5		1.342	320.00	471.00
SHA80T1.8	✓	80.0	1.8		1.605	320.00	563.04

"✓" Stocked Item
 "✱" Pre-order Only Item
 (30-40 working days delivery)



Square Hollow

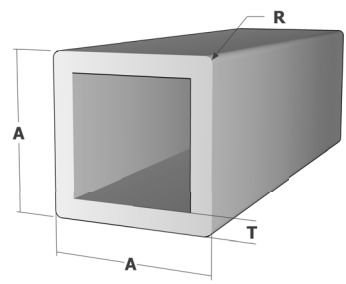

Product Code	Ex Stock	A (mm)	T (mm)	R (mm)	Mass (kg/m)	Perimeter (mm)	Area (mm ²)
SHRA80T2.5R3.5	✱	80.0	2.5	3.5	2.181	314.00	765.34
SHRA80T5R10	✱	80.0	5.0	10.0	4.092	302.80	1435.62
SHRA90T1.6R8	✱	90.0	1.6	8.0	1.556	346.27	545.98
SHA90T1.8	✱	90.0	1.8		1.810	360.00	635.10
SHA90T1.9	✱	90.0	1.9		1.908	360.00	669.59
SHA90T3	✓	90.0	3.0		2.975	359.14	1043.86
SHA90T6	✓	90.0	6.0		5.746	360.00	2016.00
SHA100T1	✱	100.0	1.0		1.129	400.00	396.00
SHA100T1.3	✱	100.0	1.3		1.463	400.00	513.27
SHA100T2	✱	100.0	2.0		2.234	400.00	784.00
SHRA100T3R3	✓	100.0	3.0	3.0	3.296	394.85	1156.50
SHA100T3	✓	100.0	3.0		3.317	400.00	1164.00
SHA100T4	✓	100.0	4.0		4.378	400.00	1536.00
SHA100T5	✓	100.0	5.0		5.415	400.00	1900.00
SHA120T3R1	✓	120.0	3.0	1	4.000	478.30	1403.40
SHA150T3	✓	150.0	3.0		5.027	600.00	1764.00
SHA150T10	✓	150.0	10.0		15.960	600.00	5600.00
SHA200T10	✓	200.0	10.0		21.660	800.00	7600.00

“✓” Stocked Item
 “*” Pre-order Only Item
 (30-40 working days delivery)



Rectangular Hollow

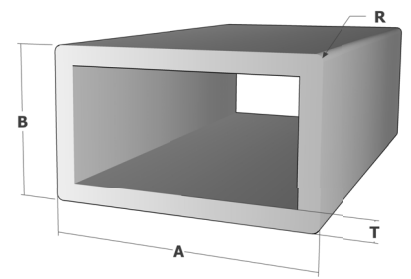

Product Code	Ex Stock	A (mm)	B (mm)	T (mm)	R (mm)	Mass (kg/m)	Perimeter (mm)	Area (mm ²)
RHA15B10T1	*	15.0	10.0	1.0		0.131	50.00	46.00
RHA15B12T1.2	*	15.0	12.0	1.2		0.168	54.00	59.04
RHRA17.8B13.8T1.4R2	*	17.8	13.8	1.4	2.0	0.226	59.80	79.14
RHRA18B14T2R1.5	*	18.0	14.0	2.0	1.5	0.314	61.43	110.10
RHA18.1B7.2T1.5	*	18.1	7.2	1.5		0.191	50.09	66.90
RHRA18.5B13T1R1.3	*	18.5	13.0	1.0	1.3	0.165	60.86	57.87
RHA20B10T1.2	✓	20.0	10.0	1.2		0.189	59.50	66.24
RHA20B12T1.2	✓	20.0	12.0	1.2		0.202	64.00	71.00
RHRA20B15T1.4R1	*	20.0	15.0	1.4	1.0	0.255	69.50	89.38
RHA20B15T2	✓	20.0	15.0	2.0		0.353	70.00	124.00
RHA21B12.5T1	*	21.0	12.5	1.0		0.180	66.50	63.00
RHA22B10T2	*	22.0	10.0	2.0		0.319	64.00	112.00
RHRA22.3B18.3T0.8R1	*	22.3	18.3	0.8	1.0	0.175	80.68	61.56
RHRA23B17T1.2R3	*	23.0	17.0	1.2	3.0	0.243	74.90	85.30
RHA23.8B10.9T1	*	23.8	10.9	1.0		0.186	68.54	65.4
RHA24B8T2	*	24.0	8.0	2.0		0.319	64.00	112.00
RHRA25B9T1.2R2	*	25.0	9.0	1.2	2.0	0.208	64.60	73.00
RHA25B15T0.45	*	25.0	15.0	0.45		0.100	79.70	35.20
RHA25B15T1	*	25.0	15.0	1.0		0.217	79.50	76.00
RHRA25B15T2.5R2	*	25.0	15.0	2.5	2.0	0.496	76.60	174.20
RHA25B20T1	*	25.0	20.0	1.0		0.245	89.50	86.00
RHA25.1B10.1T0.8	*	25.1	10.1	0.8		0.153	70.00	53.76
RHA25.4B12.7T0.9	*	25.4	12.7	0.9		0.186	75.69	65.34
RHA26.1B16.5T0.52	*	26.1	16.5	0.52		0.123	85.20	43.22
RHA28B15T1	*	28.0	15.0	1.0		0.234	85.50	82.00
RHRA28B18T0.7R4	*	28.0	18.0	0.7	4.0	0.165	85.10	58.05
RHA29.2B10T0.65	*	29.2	10.0	0.65		0.171	77.59	59.84
RHRA29.9B19.9T1R1.5	*	29.9	19.9	1.0	1.5	0.267	98.86	93.70
RHRA30B10T1.5R1.5	*	30.0	10.0	1.5	1.5	0.311	77.40	109.20
RHA30B10T2	✓	30.0	10.0	2.0		0.405	79.00	142.00
RHA30B15T1	*	30.0	15.0	1.0		0.245	90.00	86.00
RHA30B15T1.2	*	30.0	15.0	1.2		0.291	89.50	102.20
RHRA30B15T2R2.5	*	30.0	15.0	2.0	2.5	0.453	85.70	158.90
RHRA30B15T2.2R2	*	30.0	15.0	2.2	2.0	0.500	86.60	175.40
RHA30B18T1	*	30.0	18.0	1.0		0.262	95.50	92.00
RHRA30B18T1.5R2	*	30.0	18.0	1.5	2.0	0.375	92.56	131.58
RHA30B20T0.8	✓	30.0	20.0	0.8		0.221	100.00	77.50
RHRA30B20T1R1.5	*	30.0	20.0	1.0	1.5	0.269	97.40	94.30
RHA30B20T1.2	*	30.0	20.0	1.2		0.325	99.50	114.20
RHRA30B20T1.5R1.5	*	30.0	20.0	1.5	1.5	0.397	97.42	139.14

“✓” Stocked Item
 “✳” Pre-order Only Item
 (30-40 working days delivery)



Rectangular Hollow

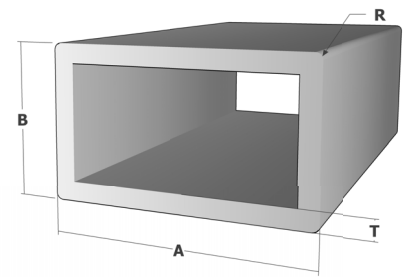

Product Code	Ex Stock	A (mm)	B (mm)	T (mm)	R (mm)	Mass (kg/m)	Perimeter (mm)	Area (mm ²)
RHRA30B20T1.6R1.5	*	30.0	20.0	1.6	1.5	0.422	97.40	147.90
RHA30B20T1.8	✓	30.0	20.0	1.8		0.476	100.00	167.00
RHRA32B16T1.5R2.2	*	32.0	16.0	1.5	2.2	0.385	92.22	135.00
RHRA32B27T1.8R1	*	32.0	27.0	1.8	1.0	0.566	116.28	198.66
RHRA34.5B12T1.2R1	*	34.5	12.0	1.2	1.0	0.300	91.50	105.20
RHRA34.8B24.8T0.65R2	*	34.8	24.8	0.65	2.0	0.211	116.00	73.92
RHA35B20T0.4	*	35.0	20.0	0.4		0.123	109.49	43.28
RHA35B20T0.5	*	35.0	20.0	0.5		0.154	109.50	54.00
RHRA35B25T1.5R3	*	35.0	25.0	1.5	3.0	0.471	114.85	165.20
RHA36B23T0.5	*	36.0	23.0	0.5		0.165	117.50	58.00
RHA37.2B24.2T1.1	*	37.2	24.2	1.1		0.371	122.30	130.24
RHRA38B7T1.2R1	*	38.0	7.0	1.2	1.0	0.289	88.30	101.50
RHA38B13T2.5	*	38.0	13.0	2.5		0.654	102.50	229.64
RHA38B25T0.5	*	38.0	25.0	0.5		0.177	125.50	62.00
RHA38B25T0.6	*	38.0	25.0	0.6		0.211	126.00	74.16
RHA38B25T0.9	*	38.0	25.0	0.9		0.314	125.50	110.20
RHA38B25T1	*	38.0	25.0	1.0		0.348	126.00	122.00
RHA38B25T1.2	*	38.0	25.0	1.2		0.415	126.00	145.44
RHRA38B25T1.5R3	✓	38.0	25.0	1.5	3.0	0.496	120.85	174.21
RHA38B25T2	✓	38.0	25.0	2.0		0.672	125.14	235.86
RHRA38B25T2.5R3	✓	38.0	25.0	2.5	3.0	0.805	120.85	282.49
RHA38B25T3	*	38.0	25.0	3.0		0.975	126.00	342.00
RHA38B25.4T0.9	*	38.0	25.4	0.9		0.317	126.50	111.10
RHA40B20T0.75	*	40.0	20.0	0.75		0.250	120.00	87.75
RHA40B20T0.9	*	40.0	20.0	0.9		0.298	119.49	104.68
RHA40B20T1	*	40.0	20.0	1.0		0.329	119.49	115.41
RHA40B20T1.2	✓	40.0	20.0	1.2		0.394	119.50	138.20
RHRA40B20T1.6R2	✓	40.0	20.0	1.6	2.0	0.509	116.60	178.54
RHRA40B20T2R2	*	40.0	20.0	2.0	2.0	0.629	116.57	220.64
RHA40B20T2.5	*	40.0	20.0	2.5		0.784	120.00	275.00
RHA40B20T3	✓	40.0	20.0	3.0		0.923	120.00	324.00
RHA40B25T2	✓	40.0	25.0	2.0		0.695	130.00	244.00
RHRA40B25T2.5R3	*	40.0	25.0	2.5	3.0	0.834	124.85	292.49
RHA40B30T0.7	*	40.0	30.0	0.7		0.274	139.49	96.04
RHA40B30T2	*	40.0	30.0	2.0		0.750	138.28	263.22
RHA40.6B23.6T0.8	*	40.6	23.6	0.8		0.286	128.40	100.20
RHA42.4B35T2	*	42.4	35.0	2.0		0.832	154.00	292.00
RHA45B20T1.5	*	45.0	20.0	1.5		0.530	129.66	186.00
RHA45B25T0.6	*	45.0	25.0	0.6		0.235	140.00	82.56
RHRA45B35T1R2	*	45.0	35.0	1.0	2.0	0.437	156.57	153.43

“✓” Stocked Item
 “*” Pre-order Only Item
 (30-40 working days delivery)



Rectangular Hollow

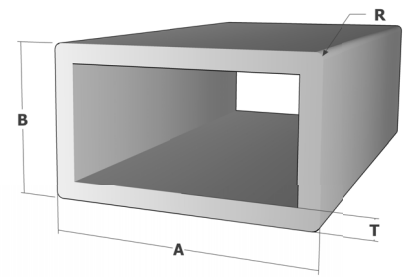

Product Code	Ex Stock	A (mm)	B (mm)	T (mm)	R (mm)	Mass (kg/m)	Perimeter (mm)	Area (mm ²)
RHA45B40T3	*	45.0	40.0	3.0		1.351	170.00	474.00
RHRA50B20T0.8R3	*	50.0	20.0	0.8	3.0	0.305	135.00	107.00
RHA50B25T0.6	*	50.0	25.0	0.6		0.252	149.50	88.56
RHA50B25T0.8	*	50.0	25.0	0.8		0.314	149.49	110.17
RHA50B25T1.2	✓	50.0	25.0	1.2		0.496	150.00	174.20
RHA50B25T1.6	✓	50.0	25.0	1.6		0.654	149.00	229.60
RHA50B25T2.5	*	50.0	25.0	2.5		0.998	150.00	350.00
RHA50B25T3	✓	50.0	25.0	3.0		1.180	150.00	414.00
RHRA50B25T3R3	✓	50.0	25.0	3.0	3.0	1.158	144.85	406.27
RHA50B30T1.2	*	50.0	30.0	1.2		0.531	160.00	186.20
RHA50B30T1.5	*	50.0	30.0	1.5		0.658	160.00	231.00
RHA50B30T2	*	50.0	30.0	2.0		0.866	160.00	304.00
RHA50B34T1.5	*	50.0	34.0	1.5		0.693	168.00	243.00
RHRA50B34T2R3.5	*	50.0	34.0	2.0	3.5	0.887	162.00	311.40
RHA50B35T3	*	50.0	35.0	3.0		1.351	170.00	474.00
RHA50B38.5T2	*	50.0	38.5	2.0		0.963	176.14	338.00
RHA50B40T2	✓	50.0	40.0	2.0		0.980	180.00	344.00
RHRA50B40T2R3	✓	50.0	40.0	2.0	3.0	0.961	174.85	337.13
RHRA50B40T3R5	*	50.0	40.0	3.0	5.0	1.385	171.42	485.97
RHA50.2B25.4T0.9	*	50.2	25.4	0.9		0.378	150.70	132.80
RHA50.8B38.1T0.9	*	50.8	38.1	0.9		0.447	177.30	156.80
RHRA51B39T1.8R1.5	*	51.0	39.0	1.8	1.5	0.881	177.43	309.11
RHA53B30T1	*	53.0	30.0	1.0		0.462	165.49	162.00
RHA54.7B11T0.7	*	54.7	11.0	0.7		0.257	131.40	90.00
RHA55B9T1.3	*	55.0	9.0	1.3		0.455	127.50	159.56
RHA55B15T0.7	*	55.0	15.0	0.7		0.324	139.49	113.72
RHA55B22T0.7	✓	55.0	22.0	0.7		0.302	153.49	105.84
RHA55B30T1	*	55.0	30.0	1.0		0.473	170.00	166.00
RHA55B40T3	*	55.0	40.0	4.0	3.0	1.522	190.00	534.00
RHRA55B40T4R2	*	55.0	40.0	4.0	2.0	1.984	186.70	696.00
RHRA55.5B11.2T0.8R1.5	*	55.5	11.2	0.8	1.5	0.297	130.82	104.16
RHA59B18T1.5	*	59.0	18.0	1.5		0.633	154.00	222.00
RHA60B20T1.2	*	60.0	20.0	1.2		0.531	159.50	186.20
RHRA60B25T1.3R3	*	60.0	25.0	1.3	3.0	0.596	164.85	209.00
RHRA60B25T1.5R3	*	60.0	25.0	1.5	3.0	0.701	164.90	246.00
RHRA60B25T1.5R5.5	*	60.0	25.0	1.5	5.5	0.672	160.56	235.91
RHRA60B26T2R5	*	60.0	26.0	2.0	5.0	0.896	163.42	314.27
RHA60B40T2	✓	60.0	40.0	2.0		1.094	200.00	384.00
RHRA60B40T2R3	✓	60.0	40.0	2.0	3.0	1.075	195.0	377.13
RHA60B40T2.5	*	60.0	40.0	2.5		1.354	199.50	475.00

"✓" Stocked Item
 "✱" Pre-order Only Item
 (30-40 working days delivery)



Rectangular Hollow

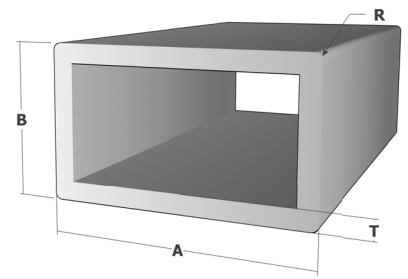

Product Code	Ex Stock	A (mm)	B (mm)	T (mm)	R (mm)	Mass (kg/m)	Perimeter (mm)	Area (mm ²)
RHA60B40T3	✓	60.0	40.0	3.0		1.607	199.20	563.90
RHRA60B40T3R6	✱	60.0	40.0	3.0	6.0	1.600	196.57	561.42
RHA60B40T3.8	✱	60.0	40.0	3.8		2.001	200.00	702.24
RHA60B40T4	✓	60.0	40.0	4.0		2.098	200.00	736.00
RHRA60B40T5R2	✱	60.0	40.0	5.0	2.0	2.555	196.57	896.57
RHRA62.8B17.6T0.8R4	✱	62.8	17.6	0.8	4.0	0.345	153.93	121.14
RHA64B25T0.9	✱	64.0	25.0	0.9		0.447	178.00	156.96
RHRA65B16T1.2R2	✓	65.0	16.0	1.2	2.0	0.568	161.50	199.30
RHA65B16T1.2	✱	65.0	16.0	1.2		0.529	158.57	185.76
RHA65B50T3	✓	65.0	50.0	3.0		1.864	229.14	653.86
RHA69.9B19.9T0.9	✱	69.9	19.9	0.9		0.451	179.00	158.31
RHA70B20T1	✱	70.0	20.0	1.0		0.500	179.49	175.41
RHRA70B25T4R2	✱	70.0	25.0	4.0	2.0	1.984	190.00	696.00
RHRA70B25.5T0.9R3.5	✱	70.0	25.5	0.9	3.5	0.447	184.99	156.83
RHA70B30.2T1	✱	70.0	30.2	1.0		0.450	199.89	157.76
RHA70B40T3	✓	70.0	40.0	3.0		1.778	219.14	623.86
RHA71.6B21.3T1	✱	71.6	21.3	1.0		0.518	185.29	181.80
RHRA74B25T1.8R3	✱	74.0	25.0	1.8	3.0	1.052	192.85	369.11
RHA75B25T2.2	✓	75.0	25.0	2.2		1.199	199.20	420.70
RHA75B40T2	✓	75.0	40.0	2.0		1.265	230.00	444.00
RHA75B45T0.8	✱	75.0	45.0	0.8		0.507	239.50	177.80
RHA75B45T3	✓	75.0	45.0	3.0		1.949	239.14	683.86
RHA75B50T3	✓	75.0	50.0	3.0		2.035	249.50	714.00
RHA76B25T1.2	✱	76.0	25.0	1.2		0.674	201.50	236.60
RHA76B25T1.5	✱	76.0	25.0	1.5		0.838	201.50	294.00
RHA76B44T0.7	✱	76.0	44.0	0.7		0.473	240.00	166.00
RHA76B44T1	✱	76.0	44.0	1.0		0.673	240.00	236.00
RHA76B44T1.2	✱	76.0	44.0	1.2		0.804	240.00	282.20
RHA76B44T1.4	✱	76.0	44.0	1.4		0.935	240.00	328.00
RHA76B44T1.5	✱	76.0	44.0	1.5		1.000	240.00	351.00
RHA76B44T2.0	✓	76.0	44.0	2.0		1.322	240.00	464.00
RHA76B25.4T0.9	✓	76.0	25.4	0.9		0.512	202.70	179.60
RHA76B44.5T0.9	✱	76.0	44.5	0.9		0.610	240.80	214.00
RHRA77B32T2.7R3	✓	77.0	32.0	2.7	3.0	1.573	212.85	551.80
RHRA78.6B35.4T2R3	✱	78.6	35.4	2.0	3.0	1.234	222.85	433.13
RHRA79.5B19.9T0.85	✱	79.5	19.9	0.85		0.473	198.00	166.10
RHRA80B16T1.1R2	✓	80.0	16.0	1.1	2.0	0.580	188.57	203.62
RHA80B20T0.7	✓	80.0	20.0	0.7		0.449	199.50	157.50
RHA80B25T1	✱	80.0	25.0	1.0		0.587	209.50	206.00
RHA80B40T0.9	✱	80.0	40.0	0.9		0.573	240.00	201.11

"✓" Stocked Item
 "✱" Pre-order Only Item
 (30-40 working days delivery)



Rectangular Hollow

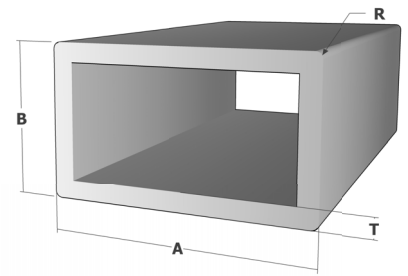

Product Code	Ex Stock	A (mm)	B (mm)	T (mm)	R (mm)	Mass (kg/m)	Perimeter (mm)	Area (mm ²)
RHA80B40T1.5	✱	80.0	40.0	1.5		1.000	240.00	350.90
RHA80B40T1.8	✓	80.0	40.0	1.8		1.194	240.00	419.00
RHRA80B40T2R3	✓	80.0	40.0	2.0	3.0	1.303	243.85	457.13
RHRA80B40T3.5R3	✱	80.0	40.0	3.5	3.0	2.254	234.80	791.00
RHA80B50T3	✓	80.0	50.0	3.0		2.120	260.00	744.00
RHRA80B50T3R3	✓	80.0	50.0	3.0	3.0	2.098	254.85	736.28
RHA80B60T6	✱	80.0	60.0	6.0		4.378	280.00	1536.00
RHA90B25T4	✱	90.0	25.0	4.0		2.440	229.50	856.00
RHA90B50T2	✓	90.0	50.0	2.0		1.550	279.14	543.86
RHA90B50T6	✓	90.0	50.0	6.0		4.378	280.00	1536.00
RHA90B60T3	✱	90.0	60.0	3.0		2.384	300.00	836.50
RHRA90B60T5R5	✱	90.0	60.0	5.0	5.0	4.051	300.00	1421.46
RHA100B15T1.2	✱	100.0	15.0	1.2		0.770	229.50	270.20
RHA100B15T1.3	✱	100.0	15.0	1.3		0.833	230.00	292.24
RHRA100B18T2.3R2	✱	100.0	18.0	2.3	2.0	1.388	236.00	486.91
RHA100B19.7T1.4	✓	100.0	19.7	1.4		0.933	238.50	372.20
RHA100B19.7T1.4	✱	100.0	19.7	1.4		0.949	238.50	333.10
RHA100B20T0.8	✱	100.0	20.0	0.8		0.540	240.00	189.44
RHA100B20T1.2	✱	100.0	20.0	1.2		0.804	239.49	282.24
RHA100B25T1.5	✱	100.0	25.0	1.5		1.043	250.00	366.00
RHA100B25T2.5	✓	100.0	25.0	2.5		1.710	249.20	600.00
RHA100B30T1.5	✱	100.0	30.0	1.5		1.086	260.00	381.00
RHA100B40T2	✓	100.0	40.0	2.0		1.550	280.00	544.00
RHA100B44T1.4	✓	100.0	44.0	1.4		1.127	288.00	395.40
RHA100B44T2	✱	100.0	44.0	2.0		1.596	288.00	560.10
RHA100B44T3	✱	100.0	44.0	3.0		2.360	288.00	828.00
RHA100B45T0.8	✱	100.0	45.0	0.8		0.613	289.49	215.17
RHA100B45T3	✱	100.0	45.0	3.0		2.377	290.00	834.00
RHA100B45T4	✱	100.0	45.0	4.0		3.124	290.00	1096.00
RHA100B50T1.5	✱	100.0	50.0	1.5		1.257	300.00	441.00
RHA100B50T2.5	✱	100.0	50.0	2.5		2.066	300.00	725.00
RHA100B50T3	✓	100.0	50.0	3.0		2.462	300.00	864.00
RHRA100B50T3R3	✓	100.0	50.0	3.0	3.0	2.440	294.85	856.28
RHA100B50T6	✓	100.0	50.0	6.0		4.719	299.20	1655.90
RHRA100B55T2.5R1.5	✱	100.0	55.0	2.5	1.5	2.135	307.00	749.00
RHA100B60T2	✱	100.0	60.0	2.0		1.778	320.00	624.00
RHRA100B60T5R1	✱	100.0	60.0	5.0	1.0	4.273	318.28	1499.22
RHA100B80T1.8	✱	100.0	80.0	1.8		1.810	360.00	635.00
RHA100B80T2	✓	100.0	80.0	2.0		2.006	360.00	704.00
RHRA101.6B25.4T0.9	✱	101.6	25.4	0.9		0.642	253.50	225.40

“✓” Stocked Item
 “*” Pre-order Only Item
 (30-40 working days delivery)



Rectangular Hollow

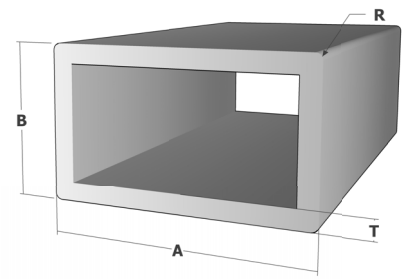

Product Code	Ex Stock	A (mm)	B (mm)	T (mm)	R (mm)	Mass (kg/m)	Perimeter (mm)	Area (mm ²)
RHA101.6B44.5T1	*	101.6	44.5	1.0		0.659	291.60	231.12
RHRA102B75T2.5R7.5	*	102.0	75.0	2.5	7.5	2.375	341.12	833.18
RHA120B25T4	✓	120.0	25.0	4.0		3.124	290.00	1096.00
RHA120B60T2	*	120.0	60.0	2.0		2.006	360.00	704.00
RHA120B60T2.9	✓	120.0	60.0	2.9		2.880	360.00	1010.40
RHA120B60T5	✓	120.0	60.0	5.0		4.845	360.00	1700.00
RHA120B60T6	✓	120.0	60.0	6.0		5.746	360.00	2016.00
RHRA120B66T3.9R2	*	120.0	66.0	3.9	2.0	3.962	369.00	1390.00
RHA120B80T6	*	120.0	80.0	6.0		6.430	400.00	2256.0
RHA125B30T2.5	✓	125.0	30.0	2.5		2.138	310.00	750.00
RHA125B40T3	✓	125.0	40.0	3.0		2.719	329.20	954.00
RHA125B50T3	✓	125.0	50.0	3.0		2.890	349.14	1013.86
RHA150B30T2.5	✓	150.0	30.0	2.5		2.494	360.00	875.00
RHA150B50T2.5	*	150.0	50.0	2.5		2.779	400.00	975.00
RHA150B50T3	✓	150.0	50.0	3.0		3.317	400.00	1164.00
RHA150B76T2.5	*	150.0	76.0	2.5		3.149	452.00	1105.00
RHA150B100T2.5	✓	150.0	100.0	2.5		3.445	500.00	1208.92
RHRA154.9B79.7T6R14.6	*	154.9	79.7	6.0	14.6	7.358	444.24	2581.72
RHA160B60T4	✓	160.0	60.0	4.0		4.834	440.00	1696.00
RHA160B60T5	*	160.0	60.0	5.0		5.985	440.00	2100.00
RHRA160B148.5T6R10	*	160.0	148.5	6.0	10.0	9.935	599.83	3485.90
RHRA160B150T6R10	*	160.0	150.0	6.0	10.0	9.986	602.83	3503.90
RHRA169B86.2T6R15.1	*	169.0	86.2	6.0	15.1	8.026	484.57	2816.07
RHA171B93T10	*	171.0	93.0	10.0		13.959	527.14	4897.79
RHA173B73T5	*	173.0	73.0	5.0		6.726	492.00	2360.00
RHRA174B86.6T7.5R5	*	174.0	86.6	7.5	5.0	10.450	512.62	3666.69
RHA180B80T3	✓	180.0	80.0	3.0		4.344	520.00	1524.10
RHA200B30T2.8	*	200.0	30.0	2.8		3.519	460.00	1234.75
RHA200B50T3	✓	200.0	50.0	3.0		4.172	500.00	1464.00
RHA200B60T2	*	200.0	60.0	2.0		2.918	520.00	1024.00
RHA200B75T3	✓	200.0	75.0	3.0		4.600	549.50	1614.00
RHA200B100T3	✓	200.0	100.0	3.0		5.027	600.00	1764.00
RHA200B100T8	✓	200.0	100.0	8.0		12.950	600.00	4544.00
RHRA232B74T10R4	*	232.0	74.0	10.0	4.0	16.393	611.14	5751.79
RHA250B50T3	✓	250.0	50.0	3.0		5.027	600.00	1764.00
RHA300B50T3	✓	300.0	50.0	3.0		6.047	699.00	2121.87
RHA317B220T16	*	317.0	220.0	16.0		46.117	1074.00	16181.46

"✓" Stocked Item
 "✱" Pre-order Only Item
 (30-40 working days delivery)



Round Tubes

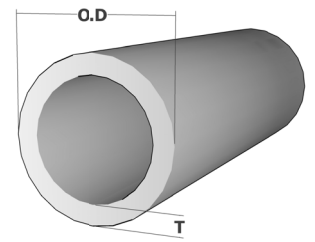

Product Code	Ex Stock	O.D (mm)	T (mm)	Mass (kg/m)	Perimeter (mm)	Area (mm ²)
RTD8T1.2	✱	8.0	1.2	0.073	25.13	25.65
RTD8T1.5	✱	8.0	1.5	0.087	25.13	30.63
RTD8.9T1.8	✱	8.9	1.8	0.114	27.95	40.15
RTD8.9T1.55	✱	8.9	1.55	0.102	27.95	35.79
RTD9T1.4	✱	9.0	1.4	0.095	28.27	33.43
RTD9T2	✓	9.0	2.0	0.125	28.26	43.98
RTD9.53T1.42	✱	9.5	0.9	0.069	29.85	24.32
RTD9.53T1.42	✓	9.53	1.42	0.103	29.92	36.18
RTD10T1	✱	10.0	1.0	0.081	31.40	28.27
RTD10T1.2	✓	10.0	1.2	0.095	31.40	33.18
RTD10T1.5	✱	10.0	1.5	0.114	31.42	40.01
RTD10T2	✱	10.0	2.0	0.143	31.42	50.27
RTD10.6T1.6	✱	10.6	1.6	0.129	33.28	45.21
RTD11T0.7	✱	11.0	0.7	0.065	34.60	22.65
RTD11T2	✱	11.0	2.0	0.161	34.56	56.55
RTD11T3	✱	11.0	3.0	0.215	34.56	75.40
RTD11.5T0.8	✱	11.5	0.8	0.077	36.11	26.88
RTD11.8T0.55	✱	11.8	0.55	0.080	37.05	19.43
RTD11.8T0.95	✱	11.8	0.95	0.092	37.07	32.38
RTD12T0.8	✱	12.0	0.8	0.080	37.68	28.13
RTD12T0.9	✱	12.0	0.9	0.089	37.68	31.37
RTD12T1	✱	12.0	1.0	0.098	37.68	34.56
RTD12T1.2	✱	12.0	1.2	0.116	37.68	40.69
RTD12T2	✱	12.0	2.0	0.179	37.70	62.83
RTD12T2.6	✱	12.0	2.6	0.219	37.70	76.78
RTD12T2.6	✱	12.0	2.6	0.219	37.70	76.78
RTD12T3.9	✱	12.0	3.9	0.283	37.70	99.24
RTD12.4T0.8	✱	12.4	0.8	0.083	38.96	29.15
RTD12.5T2	✱	12.5	2.0	0.188	39.27	65.97
RTD12.7T1.4	✓	12.7	1.4	0.142	39.88	49.68
RTD13T1	✱	13.0	1.0	0.107	40.84	37.70
RTD13T1.1	✱	13.0	1.1	0.117	40.84	41.12
RTD13T1.2	✱	13.0	1.2	0.349	40.84	44.49
RTD13T1.4	✱	13.0	1.4	0.453	40.84	51.02
RTD13T2	✱	13.0	2.0	0.500	40.84	69.12
RTD13T4.7	✱	13.0	4.7	0.262	40.84	112.55
RTD13.7T2	✱	13.7	2.0	0.209	43.02	73.48
RTD13.8T0.5	✱	13.8	0.5	0.060	43.35	20.89
RTD14T0.65	✱	14.0	0.65	0.078	43.96	27.25
RTD14T0.7	✱	14.0	0.7	0.083	43.96	29.23

"✓" Stocked Item
 "✱" Pre-order Only Item
 (30-40 working days delivery)



Round Tubes

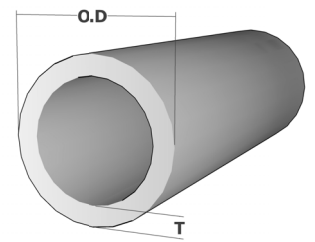

Product Code	Ex Stock	O.D (mm)	T (mm)	Mass (kg/m)	Perimeter (mm)	Area (mm ²)
RTD14T0.8	✱	14.0	0.8	0.095	43.96	33.16
RTD14T0.9	✱	14.0	0.9	0.106	43.96	37.02
RTD14T1.2	✱	14.0	1.2	0.138	43.96	48.26
RTD14T1.5	✱	14.0	1.5	0.168	43.96	58.88
RTD14T2	✓	14.0	2.0	0.215	44.00	75.40
RTD14T3.6	✱	14.0	3.6	0.335	44.00	117.62
RTD14.5T3.85	✱	14.5	3.85	0.367	45.55	128.81
RTD14.8T1.2	✱	14.8	1.2	0.146	46.50	51.27
RTD15T0.5	✱	15.0	0.5	0.065	47.12	22.78
RTD15T0.65	✱	15.0	0.65	0.084	47.13	29.30
RTD15T0.8	✱	15.0	0.8	0.102	47.10	35.67
RTD15T1	✱	15.0	1.0	0.125	47.12	43.98
RTD15T1.1	✱	15.0	1.1	0.137	47.13	48.04
RTD15T1.2	✱	15.0	1.2	0.148	47.10	52.00
RTD15T2	✱	15.0	2.0	0.233	47.13	81.68
RTD15T1.41	✓	15.0	1.41	0.170	47.10	59.79
RTD15T4.1	✱	15.0	4.1	0.400	47.13	140.40
RTD16T0.6	✱	16.0	0.6	0.083	50.24	29.01
RTD16T0.7	✱	16.0	0.7	0.096	50.27	33.65
RTD16T0.8	✱	16.0	0.8	0.109	50.24	38.18
RTD16T1	✱	16.0	1.0	0.134	50.24	47.10
RTD16T1.1	✱	16.0	1.1	0.147	50.24	51.47
RTD16T1.2	✱	16.0	1.2	0.159	50.24	55.77
RTD16T1.3	✓	16.0	1.3	0.171	50.24	60.00
RTD16T2	✱	16.0	2.0	0.251	50.27	88.00
RTD16T3	✱	16.0	3.0	0.349	50.27	122.52
RTD16T4	✱	16.0	4.0	0.430	50.27	150.80
RTD16T4.6	✱	16.0	4.6	0.470	50.27	164.75
RTD16.5T1.2	✱	16.5	1.2	0.164	51.81	57.65
RTD17T1	✱	17.0	1.0	0.143	53.41	50.27
RTD17T2	✱	17.0	2.0	0.269	53.41	94.25
RTD17T3	✓	17.0	3.0	0.376	53.41	132.00
RTD17T4	✱	17.0	4.0	0.466	53.41	163.36
RTD17T5.1	✱	17.0	5.1	0.543	53.41	190.66
RTD17T5.6	✱	17.0	5.6	0.572	53.41	200.56
RTD17T5.9	✱	17.0	5.9	0.586	53.41	205.74
RTD17.5T2	✱	17.5	2.0	0.277	54.99	97.39
RTD18T1	✱	18.0	1.0	0.152	56.55	53.41
RTD18T1.2	✱	18.0	1.2	0.180	56.52	63.34
RTD18T1.5	✱	18.0	1.5	0.221	56.52	77.75

"✓" Stocked Item
 "✱" Pre-order Only Item
 (30-40 working days delivery)



Round Tubes

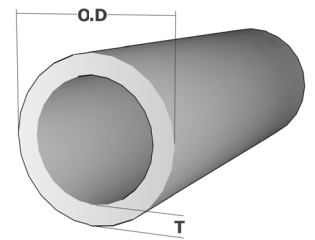

Product Code	Ex Stock	O.D (mm)	T (mm)	Mass (kg/m)	Perimeter (mm)	Area (mm ²)
RTD18T2	✱	18.0	2.0	0.287	56.55	100.53
RTD18T3	✓	18.0	3.0	0.403	56.55	141.37
RTD18T4	✱	18.0	4.0	0.502	56.55	176.00
RTD18T5.6	✱	18.0	5.6	0.622	56.55	218.15
RTD18T6.1	✱	18.0	6.1	0.650	56.55	228.05
RTD18.5T6.65	✱	18.5	6.7	0.706	58.12	247.57
RTD18.6T0.8	✱	18.6	0.8	0.128	58.43	44.80
RTD19T0.6	✱	19.0	0.6	0.099	59.69	34.68
RTD19T0.7	✱	19.0	0.7	0.115	59.66	40.22
RTD19T0.8	✱	19.0	0.8	0.130	59.70	45.74
RTD19T0.9	✱	19.0	0.9	0.146	59.66	51.15
RTD19T1	✱	19.0	1.0	0.161	59.66	56.52
RTD19T1.1	✱	19.0	1.1	0.176	59.66	61.83
RTD19T1.2	✓	19.0	1.2	0.191	59.66	67.07
RTD19T1.4	✓	19.0	1.4	0.221	59.66	77.37
RTD19T1.5	✱	19.0	1.5	0.235	59.66	82.43
RTD19T1.6	✓	19.0	1.6	0.249	59.66	87.42
RTD19T1.85	✱	19.0	1.85	0.284	59.66	99.62
RTD19T2	✓	19.0	2.0	0.304	59.66	106.76
RTD19T3	✓	19.0	3.0	0.430	59.69	150.80
RTD19T4	✱	19.0	4.0	0.537	60.00	188.50
RTD19T6.1	✱	19.0	6.1	0.705	59.70	247.21
RTD19T6.6	✱	19.0	6.6	0.733	59.70	257.11
RTD19.2T1.5	✱	19.2	1.5	0.238	60.29	83.37
RTD19.3T1.4	✱	19.3	1.4	0.224	60.60	78.69
RTD20T0.7	✱	20.0	0.7	0.121	62.80	42.42
RTD20T1	✱	20.0	1.0	0.170	62.80	59.66
RTD20T1.2	✓	20.0	1.2	0.202	62.80	70.84
RTD20T1.3	✱	20.0	1.3	0.218	62.80	76.37
RTD20T1.5	✱	20.0	1.5	0.248	62.80	87.18
RTD20T2	✱	20.0	2.0	0.322	62.83	113.10
RTD20T3	✓	20.0	3.0	0.457	62.83	160.22
RTD20T4	✱	20.0	4.0	0.573	62.83	201.06
RTD20T6.6	✱	20.0	6.6	0.792	62.83	277.84
RTD20T6.85	✱	20.0	6.85	0.807	62.80	282.99
RTD20T7.1	✱	20.0	7.1	0.820	62.83	287.74
RTD20.2T5.8	✱	20.2	5.8	0.748	63.43	262.39
RTD20.5T1	✱	20.5	1.0	0.175	64.40	61.26
RTD20.5T2	✱	20.5	2.0	0.331	64.40	116.24
RTD21T0.8	✱	21.0	0.8	0.145	65.94	50.74

"✓" Stocked Item
 "✱" Pre-order Only Item
 (30-40 working days delivery)



Round Tubes

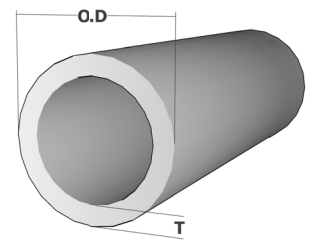

Product Code	Ex Stock	O.D (mm)	T (mm)	Mass (kg/m)	Perimeter (mm)	Area (mm ²)
RTD21T1	✱	21.0	1.0	0.179	66.00	62.83
RTD21T2	✱	21.0	2.0	0.340	66.00	119.40
RTD21T2.3	✱	21.0	2.3	0.385	65.94	135.05
RTD21T2.5	✱	21.0	2.5	0.414	65.97	145.30
RTD21T3	✱	21.0	3.0	0.484	66.00	169.65
RTD21T4	✓	21.0	4.0	0.609	66.00	213.63
RTD21T5	✱	21.0	5.0	0.716	66.00	251.33
RTD21T7.1	✱	21.0	7.1	0.884	65.97	310.00
RTD21T7.6	✱	21.0	7.6	0.912	66.00	319.94
RTD21.5T2	✱	21.5	2.0	0.349	67.54	122.52
RTD21.6T0.8	✱	21.6	0.8	0.149	67.86	52.34
RTD21.7T0.65	✱	21.7	0.65	0.123	68.17	43.00
RTD21.9T3	✱	21.9	3.0	0.507	68.77	178.04
RTD21.8T0.8	✱	21.8	0.8	0.150	68.45	52.75
RTD21.8T1	✱	21.8	1.0	0.186	68.45	65.34
RTD22T0.7	✱	22.0	0.7	0.133	69.08	46.82
RTD22T0.8	✱	22.0	0.8	0.152	69.12	53.30
RTD22T0.9	✱	22.0	0.9	0.170	69.08	59.63
RTD22T1	✓	22.0	1.0	0.188	69.12	65.94
RTD22T1.1	✱	22.0	1.1	0.206	69.08	72.23
RTD22T1.2	✱	22.0	1.2	0.223	69.08	78.37
RTD22T1.4	✱	22.0	1.4	0.258	69.08	90.56
RTD22T1.8	✱	22.0	1.8	0.325	69.08	114.17
RTD22T2	✱	22.0	2.0	0.358	69.08	125.60
RTD22T2.15	✱	22.0	2.15	0.382	69.08	134.01
RTD22T2.6	✱	22.0	2.6	0.451	69.08	158.38
RTD22T3	✓	22.0	3.0	0.510	69.11	179.10
RTD22T4	✱	22.0	4.0	0.645	69.11	226.20
RTD22T5	✱	22.0	5.0	0.761	69.11	267.00
RTD22T8.1	✱	22.0	8.1	1.008	69.11	353.71
RTD22.2T1.1	✱	22.2	1.1	0.208	69.71	72.88
RTD22.5T1	✱	22.5	1.0	0.192	70.70	67.54
RTD22.6T0.55	✱	22.6	0.55	0.109	71.00	38.10
RTD22.8T1.3	✱	22.8	1.3	0.250	71.59	87.76
RTD23T1	✱	23.0	1.0	0.197	72.26	69.11
RTD23T2	✱	23.0	2.0	0.376	72.26	132.00
RTD23T3	✓	23.0	3.0	0.537	72.26	188.50
RTD23T4	✱	23.0	4.0	0.680	72.26	238.76
RTD23T5	✱	23.0	5.0	0.806	72.26	282.74
RTD23T8.6	✱	23.0	8.6	1.109	72.26	389.06

"✓" Stocked Item
 "*" Pre-order Only Item
 (30-40 working days delivery)



Round Tubes

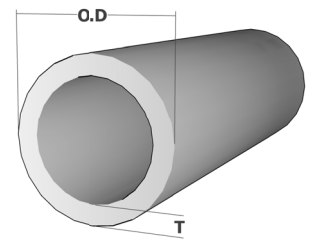

Product Code	Ex Stock	O.D (mm)	T (mm)	Mass (kg/m)	Perimeter (mm)	Area (mm ²)
RTD23.9T1	*	23.9	1.0	0.205	75.05	71.91
RTD24T1	*	24.0	1.0	0.206	75.40	72.26
RTD24T2	✓	24.0	2.0	0.394	75.40	138.23
RTD24T2.5	*	24.0	2.5	0.481	75.40	168.86
RTD24T3	*	24.0	3.0	0.564	75.40	197.92
RTD24T4	*	24.0	4.0	0.716	75.40	251.33
RTD24T5	*	24.0	5.0	0.851	75.40	298.45
RTD24T6	*	24.0	6.0	0.967	75.40	339.30
RTD24T7	*	24.0	7.0	1.065	75.40	373.85
RTD24T9.1	*	24.0	9.1	1.214	75.40	426.00
RTD24.5T1.25	*	24.5	1.25	0.260	77.00	91.30
RTD24.5T2	*	24.5	2.0	0.403	76.97	141.37
RTD24.8T1.7	*	24.8	1.7	0.352	77.90	123.40
RTD24.8T1.9	*	24.8	1.9	0.389	77.87	136.62
RTD24.8T1.1	*	24.8	1.1	0.234	78.19	82.21
RTD24.9T1.2	*	24.9	1.2	0.255	78.19	89.30
RTD25T0.7	*	25.0	0.7	0.152	78.54	53.44
RTD25T0.8	*	25.0	0.8	0.173	78.50	60.79
RTD25T0.9	*	25.0	0.9	0.194	78.50	68.11
RTD25T1	*	25.0	1.0	0.215	78.50	75.36
RTD25T1.1	*	25.0	1.1	0.235	78.50	82.55
RTD25T1.2	*	25.0	1.2	0.256	78.50	89.68
RTD25T1.4	*	25.0	1.4	0.296	78.50	103.75
RTD25T1.5	*	25.0	1.5	0.315	78.50	110.69
RTD25T1.8	*	25.0	1.8	0.374	78.50	131.13
RTD25T1.9	✓	25.0	1.9	0.393	78.50	137.82
RTD25T2	*	25.0	2.0	0.412	78.54	144.51
RTD25T2.5	*	25.0	2.5	0.503	78.50	176.63
RTD25T3	✓	25.0	3.0	0.591	78.50	207.24
RTD25T4	*	25.0	4.0	0.752	78.54	263.90
RTD25T5	*	25.0	5.0	0.895	78.50	314.00
RTD25T5.5	*	25.0	5.5	0.960	78.54	336.94
RTD25T6	*	25.0	6.0	1.020	78.50	357.96
RTD25T7.3	*	25.0	7.3	1.156	78.50	405.72
RTD25T8.25	*	25.0	8.25	1.237	78.50	433.91
RTD25T9.1	*	25.0	9.1	1.295	78.50	454.33
RTD25T9.6	*	25.0	9.6	1.324	78.50	464.45
RTD25.4T1	*	25.4	1.0	0.218	79.76	76.62
RTD25.4T1.2	✓	25.4	1.2	0.260	79.76	91.19
RTD25.4T2.8	*	25.4	2.8	0.566	79.76	198.70

"✓" Stocked Item
 "✱" Pre-order Only Item
 (30-40 working days delivery)



Round Tubes

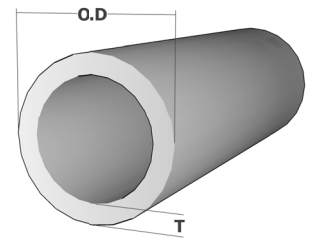

Product Code	Ex Stock	O.D (mm)	T (mm)	Mass (kg/m)	Perimeter (mm)	Area (mm ²)
RTD25.5T1	✱	25.5	1.0	0.219	80.11	77.00
RTD25.5T2	✱	25.5	2.0	0.421	80.11	147.66
RTD25.6T1.4	✱	25.6	1.4	0.303	80.38	106.38
RTD25.9T1.3	✱	25.9	1.3	0.286	81.33	100.42
RTD26T1	✱	26.0	1.0	0.224	81.68	78.54
RTD26T2	✱	26.0	2.0	0.430	81.68	150.80
RTD26T3	✓	26.0	3.0	0.617	81.68	216.66
RTD26T4	✱	26.0	4.0	0.788	81.68	276.46
RTD26T5	✱	26.0	5.0	0.940	81.68	329.87
RTD26T7	✱	26.0	7.0	1.191	81.68	417.83
RTD26T8.7	✱	26.0	8.7	1.347	81.64	472.60
RTD26T10.1	✱	26.0	10.1	1.438	81.68	504.51
RTD26.2T1.7	✱	26.2	1.7	0.373	82.27	130.78
RTD26.3T2	✱	26.3	2.0	0.435	82.58	152.60
RTD27T0.7	✱	27.0	0.7	0.165	84.82	57.84
RTD27T1	✱	27.0	1.0	0.233	84.82	81.68
RTD27T1.2	✱	27.0	1.2	0.277	84.78	97.21
RTD27T2	✱	27.0	2.0	0.448	84.82	157.10
RTD27T2.2	✱	27.0	2.2	0.489	84.78	171.41
RTD27T3	✓	27.0	3.0	0.645	84.82	226.20
RTD27T4	✱	27.0	4.0	0.823	84.78	288.88
RTD27T5	✱	27.0	5.0	0.985	84.82	345.58
RTD27T10.6	✱	27.0	10.6	1.556	84.80	546.14
RTD27.2T4.5	✱	27.2	4.5	0.914	85.41	320.75
RTD27.5T1	✱	27.5	1.0	0.237	86.40	83.25
RTD27.5T2	✱	27.5	2.0	0.457	86.40	160.22
RTD27.6T1.3	✱	27.6	1.3	0.306	86.70	107.41
RTD27.8T1	✱	27.8	1.0	0.240	87.30	84.20
RTD27.9T0.55	✱	27.9	0.55	0.135	87.61	47.23
RTD28T0.8	✱	28.0	0.8	0.195	87.92	68.33
RTD28T1	✱	28.0	1.0	0.242	87.92	84.78
RTD28T1.1	✱	28.0	1.1	0.265	87.92	92.91
RTD28T1.5	✱	28.0	1.5	0.356	87.92	124.82
RTD28T1.8	✱	28.0	1.8	0.422	87.92	148.08
RTD28T2	✱	28.0	2.0	0.466	88.00	163.36
RTD28T2.2	✱	28.0	2.2	0.508	88.00	178.32
RTD28T3	✱	28.0	3.0	0.672	88.00	235.62
RTD28T3.2	✱	28.0	3.2	0.710	87.92	249.19
RTD28T4	✓	28.0	4.0	0.859	87.92	301.44
RTD28T5	✱	28.0	5.0	1.030	88.00	361.28

"✓" Stocked Item
 "✱" Pre-order Only Item
 (30-40 working days delivery)



Round Tubes

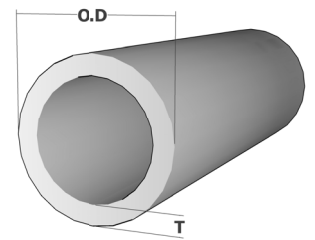

Product Code	Ex Stock	O.D (mm)	T (mm)	Mass (kg/m)	Perimeter (mm)	Area (mm ²)
RTD28T6.9	✱	28.0	6.9	1.304	88.00	457.39
RTD28T11.1	✱	28.0	11.1	1.680	88.00	589.33
RTD28.3T1	✱	28.3	1.0	0.244	88.86	85.72
RTD28.5T2.2	✱	28.5	2.2	0.518	89.49	181.68
RTD28.6T0.8	✱	28.6	0.8	0.199	89.80	69.90
RTD28.7T2.5	✓	28.7	2.5	0.586	90.12	205.67
RTD29T0.75	✱	29.0	0.75	0.190	91.11	66.56
RTD29T1.1	✱	29.0	1.1	0.275	91.06	96.37
RTD29T2	✱	29.0	2.0	0.484	91.11	169.65
RTD29T3	✱	29.0	3.0	0.699	91.11	245.10
RTD29T4	✱	29.0	4.0	0.895	91.11	314.20
RTD29T5	✱	29.0	5.0	1.074	91.11	377.00
RTD29T11.6	✱	29.0	11.6	1.807	91.11	634.10
RTD29.4T1.7	✱	29.4	1.7	0.421	92.32	147.86
RTD29.8T1.9	✱	29.8	1.9	0.474	93.57	166.45
RTD30T1	✱	30.0	1.0	0.260	94.20	91.06
RTD30T1.25	✱	30.0	1.25	0.322	94.25	112.90
RTD30T1.5	✓	30.0	1.5	0.383	94.20	134.34
RTD30T2	✱	30.0	2.0	0.501	94.25	175.93
RTD30T3	✓	30.0	3.0	0.725	94.20	254.34
RTD30T4	✱	30.0	4.0	0.931	94.25	326.73
RTD30T5	✱	30.0	5.0	1.119	94.25	392.70
RTD30T12.1	✱	30.0	12.1	1.939	94.25	680.44
RTD30.5T2.5	✱	30.5	2.5	0.627	95.82	219.91
RTD31T2	✱	31.0	2.0	0.519	97.40	182.21
RTD31T3	✱	31.0	3.0	0.752	97.40	263.90
RTD31T3.25	✱	31.0	3.25	0.807	97.34	283.19
RTD31T4	✱	31.0	4.0	0.967	97.40	339.29
RTD31T5	✓	31.0	5.0	1.164	97.40	408.40
RTD31T12.6	✱	31.0	12.6	2.076	97.40	728.35
RTD31.5T2	✱	31.5	2.0	0.528	98.91	185.26
RTD31.5T3	✱	31.5	3.0	0.765	98.91	268.47
RTD31.6T1.8	✱	31.6	1.8	0.480	99.22	168.43
RTD31.8T3.15	✱	31.8	3.15	0.808	99.85	283.38
RTD32T0.8	✱	32.0	0.8	0.223	100.48	78.37
RTD32T1.2	✱	32.0	1.2	0.331	100.48	116.05
RTD32T1.4	✱	32.0	1.4	0.383	100.48	134.52
RTD32T1.5	✱	32.0	1.5	0.409	100.48	143.66
RTD32T1.6	✓	32.0	1.6	0.435	100.48	152.73
RTD32T2	✱	32.0	2.0	0.537	100.48	188.40

"✓" Stocked Item
 "✱" Pre-order Only Item
 (30-40 working days delivery)



Round Tubes

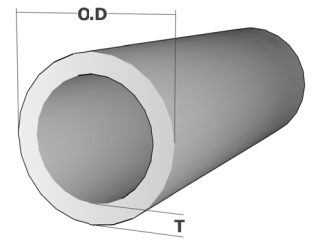

Product Code	Ex Stock	O.D (mm)	T (mm)	Mass (kg/m)	Perimeter (mm)	Area (mm ²)
RTD32T2.5	✱	32.0	2.5	0.660	100.48	231.58
RTD32T3	✓	32.0	3.0	0.779	100.48	273.18
RTD32T3.2	✱	32.0	3.2	0.825	100.48	289.38
RTD32T4	✱	32.0	4.0	1.003	100.53	351.86
RTD32T5	✱	32.0	5.0	1.208	100.48	423.90
RTD32T7	✱	32.0	7.0	1.566	100.48	549.50
RTD32T8	✱	32.0	8.0	1.719	100.53	603.19
RTD32T13.1	✱	32.0	13.1	2.217	100.31	777.83
RTD32.6T1.2	✱	32.6	1.2	0.337	102.36	118.32
RTD33T2	✱	33.0	2.0	0.555	103.67	194.78
RTD33T3	✱	33.0	3.0	0.806	103.67	282.74
RTD33T4	✱	33.0	4.0	1.039	103.67	364.42
RTD33T5	✱	33.0	5.0	1.253	103.67	439.80
RTD33T13.6	✱	33.0	13.6	2.362	103.67	828.88
RTD33.8T4.8	✓	33.8	4.8	1.246	106.13	437.09
RTD34T1	✱	34.0	1.0	0.295	106.76	103.62
RTD34T1.8	✱	34.0	1.8	0.519	106.76	181.99
RTD34T2	✱	34.0	2.0	0.573	106.76	200.96
RTD34T2.5	✱	34.0	2.5	0.705	106.80	247.40
RTD34T3	✱	34.0	3.0	0.832	106.76	292.02
RTD34T4	✱	34.0	4.0	1.074	106.76	376.80
RTD34T5	✓	34.0	5.0	1.298	106.81	455.53
RTD35T0.55	✱	35.0	0.55	0.170	109.96	59.53
RTD35T0.6	✱	35.0	0.6	0.185	109.90	64.81
RTD35T0.75	✱	35.0	0.75	0.230	109.90	80.66
RTD35T1.1	✱	35.0	1.1	0.334	109.90	117.09
RTD35T1.5	✱	35.0	1.5	0.450	109.90	157.79
RTD35T1.8	✱	35.0	1.8	0.535	109.90	187.65
RTD35T2	✱	35.0	2.0	0.591	109.90	207.24
RTD35T4	✱	35.0	4.0	1.110	110.00	389.56
RTD35T5	✱	35.0	5.0	1.343	110.00	471.24
RTD35T6.5	✱	35.0	6.5	1.658	109.90	581.67
RTD35T12.3	✱	35.0	12.3	2.499	109.90	876.72
RTD35.2T0.8	✱	35.2	0.8	0.246	110.53	86.41
RTD35.4T1.4	✱	35.4	1.4	0.426	111.16	149.46
RTD35.5T0.8	✱	35.5	0.8	0.248	111.47	87.17
RTD35.5T0.9	✱	35.5	0.9	0.279	111.47	97.78
RTD35.5T1.2	✱	35.5	1.2	0.368	111.47	129.24
RTD35.8T2	✱	35.8	2.0	0.605	112.41	212.26
RTD36T0.8	✱	36.0	0.8	0.252	113.04	88.42

"✓" Stocked Item
 "✱" Pre-order Only Item
 (30-40 working days delivery)



Round Tubes

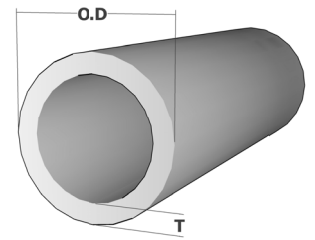

Product Code	Ex Stock	O.D (mm)	T (mm)	Mass (kg/m)	Perimeter (mm)	Area (mm ²)
RTD36T1.2	✱	36.0	1.2	0.374	113.04	131.13
RTD36T1.25	✱	36.0	1.25	0.389	113.10	136.46
RTD36T2	✓	36.0	2.0	0.609	113.10	213.63
RTD36T4	✱	36.0	4.0	1.146	113.10	402.12
RTD36T5	✱	36.0	5.0	1.388	113.10	487.00
RTD36.5T8.75	✱	36.5	8.75	2.174	114.67	762.82
RTD36.7T1.1	✱	36.7	1.1	0.350	115.24	122.96
RTD37T13.4	✱	37.0	13.4	2.830	116.18	992.99
RTD37T5	✱	37.0	5.0	1.433	116.24	502.66
RTD38T1	✱	38.0	1.0	0.331	119.32	116.18
RTD38T1.1	✱	38.0	1.1	0.363	119.32	127.45
RTD38T1.4	✓	38.0	1.4	0.459	119.32	160.89
RTD38T1.8	✱	38.0	1.8	0.583	119.32	204.60
RTD38T2.5	✱	38.0	2.5	0.794	119.32	278.68
RTD38T2.9	✱	38.0	2.9	0.911	119.32	319.62
RTD38T3	✓	38.0	3.0	0.940	119.32	329.70
RTD38T3.5	✱	38.0	3.5	1.081	119.32	379.16
RTD38T8	✱	38.0	8.0	2.149	119.32	753.98
RTD38.1T3	✱	38.1	3.0	0.942	119.63	330.64
RTD38.4T1.1	✱	38.4	1.1	0.367	120.58	128.83
RTD39T1.05	✱	39.0	1.05	0.357	122.46	125.12
RTD39T4	✱	39.0	4.0	1.253	122.46	439.60
RTD39.12T1.36	✱	39.12	1.36	0.460	122.90	161.50
RTD40T0.9	✱	40.0	0.9	0.315	125.66	110.55
RTD40T1.05	✱	40.0	1.05	0.366	125.60	128.42
RTD40T1.25	✱	40.0	1.25	0.434	125.70	152.17
RTD40T1.5	✱	40.0	1.5	0.517	125.60	181.34
RTD40T2	✱	40.0	2.0	0.680	125.66	238.76
RTD40T3	✱	40.0	3.0	0.994	125.66	348.72
RTD40T4	✓	40.0	4.0	1.289	125.66	452.16
RTD40T5	✱	40.0	5.0	1.567	125.66	549.78
RTD40.5T0.8	✱	40.5	0.8	0.284	127.80	99.73
RTD40.7T0.75	✱	40.7	0.75	0.268	127.80	94.08
RTD41T0.8	✱	41.0	0.8	0.288	128.74	100.98
RTD41T0.9	✱	41.0	0.9	0.323	128.74	113.32
RTD41T1.2	✱	41.0	1.2	0.427	128.74	149.97
RTD41T1.5	✱	41.0	1.5	0.530	128.74	186.14
RTD41T4	✱	41.0	4.0	1.325	128.74	465.00
RTD41T5	✱	41.0	5.0	1.611	128.74	565.20
RTD41.8T0.8	✱	41.8	0.8	0.294	131.25	102.99

"✓" Stocked Item
 "✱" Pre-order Only Item
 (30-40 working days delivery)



Round Tubes

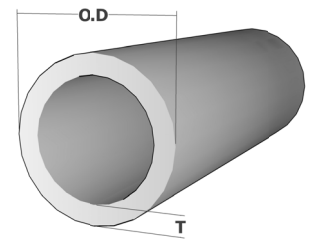

Product Code	Ex Stock	O.D (mm)	T (mm)	Mass (kg/m)	Perimeter (mm)	Area (mm ²)
RTD41.8T2.8	✱	41.8	2.8	0.977	131.25	342.89
RTD42T1.1	✱	42.0	1.1	0.403	131.88	141.27
RTD42T1.2	✱	42.0	1.2	0.438	131.88	153.73
RTD42T1.4	✱	42.0	1.4	0.509	131.88	178.48
RTD42T9	✱	42.0	9.0	2.658	131.88	932.58
RTD43T1.5	✱	43.0	1.5	0.557	135.02	195.47
RTD43T2	✱	43.0	2.0	0.734	135.02	257.48
RTD43T2.5	✱	43.0	2.5	0.906	135.02	317.93
RTD43T3	✱	43.0	3.0	1.074	135.02	376.80
RTD43.3T2.8	✱	43.3	2.8	1.015	135.96	356.08
RTD43.5T0.6	✱	43.5	0.6	0.230	136.66	80.86
RTD44T1.25	✱	44.0	1.25	0.478	138.20	167.88
RTD44T3.2	✱	44.0	3.2	1.168	138.16	409.96
RTD45T1	✱	45.0	1.0	0.394	141.30	138.16
RTD45T1.15	✱	45.0	1.15	0.451	141.30	158.34
RTD45T1.35	✱	45.0	1.35	0.527	141.30	185.03
RTD45T1.6	✱	45.0	1.6	0.621	141.30	218.04
RTD45T3	✓	45.0	3.0	1.128	141.30	395.64
RTD47T5	✱	47.0	5.0	1.879	147.58	659.40
RTD48T1.25	✱	48.0	1.25	0.523	150.80	183.59
RTD48T1.5	✓	48.0	1.5	0.624	150.72	219.02
RTD48.4T2.6	✓	48.4	2.6	1.066	151.98	373.91
RTD49.5T0.8	✱	49.5	0.8	0.349	155.43	122.33
RTD49.5T1.4	✱	49.5	1.4	0.603	155.43	211.45
RTD49.5T1.5	✱	49.5	1.5	0.644	155.43	226.08
RTD49.7T3	✱	49.7	3.0	1.254	156.06	439.91
RTD49.8T1.9	✓	49.8	1.9	0.814	156.37	285.77
RTD50T1	✱	50.0	1.0	0.439	157.00	153.86
RTD50T1.2	✱	50.0	1.2	0.524	157.00	183.88
RTD50T1.4	✱	50.0	1.4	0.609	157.00	213.65
RTD50T1.5	✱	50.0	1.5	0.651	157.00	228.44
RTD50T2.5	✱	50.0	2.5	1.063	157.00	372.88
RTD50T2.7	✱	50.0	2.7	1.143	157.00	401.01
RTD50T2.8	✱	50.0	2.8	1.183	157.00	414.98
RTD50T3	✓	50.0	3.0	1.262	157.00	442.74
RTD50T3.5	✱	50.0	3.5	1.456	157.00	511.29
RTD50T3.8	✱	50.0	3.8	1.571	157.00	551.26
RTD50T4	✓	50.0	4.0	1.647	157.00	577.76
RTD50T5	✓	50.0	5.0	2.014	157.00	706.50
RTD50T5.5	✱	50.0	5.5	2.190	157.00	768.52

"✓" Stocked Item
 "*" Pre-order Only Item
 (30-40 working days delivery)



Round Tubes

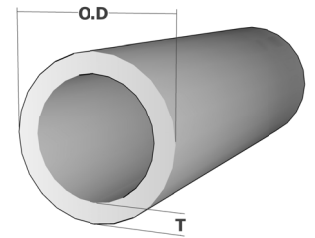

Product Code	Ex Stock	O.D (mm)	T (mm)	Mass (kg/m)	Perimeter (mm)	Area (mm ²)
RTD50T9.7	*	50.0	9.7	3.498	157.00	1227.46
RTD50.8T3.0	*	50.8	3.0	1.284	159.59	450.50
RTD51.5T2.5	*	51.5	2.5	1.097	161.79	384.85
RTD52T1.25	*	52.0	1.25	0.568	163.40	199.29
RTD53.8T0.6	*	53.8	0.6	0.286	169.00	100.28
RTD54T0.7	*	54.0	0.7	0.334	169.56	117.15
RTD54.5T3.2	*	54.5	3.2	1.469	171.13	515.46
RTD56T1.25	*	56.0	1.25	0.613	175.90	215.00
RTD56T15.5	*	56.0	15.5	5.621	175.93	1972.14
RTD56.5T3	*	56.5	3.0	1.437	177.50	1972.14
RTD57T4	✓	57.0	4.0	1.897	178.98	665.68
RTD59.7T3	*	59.7	3.0	1.522	187.46	534.11
RTD60T1.25	*	60.0	1.25	0.658	188.50	230.71
RTD60T1.5	*	60.0	1.5	0.785	188.40	275.54
RTD60T5	✓	60.0	5.0	2.461	188.40	863.50
RTD60T9	*	60.0	9.0	4.110	188.50	1442.00
RTD60.9T8	*	60.9	8.0	3.789	190.32	1329.52
RTD63T1.5	*	63.0	1.5	0.826	197.82	289.67
RTD63T6.5	✓	63.0	6.5	3.288	197.92	1153.75
RTD63.5T3	*	63.5	3.0	1.625	199.49	570.20
RTD64T0.8	*	64.0	0.8	0.452	200.96	158.76
RTD64T1.25	*	64.0	1.25	0.702	201.10	246.42
RTD67.4T0.7	*	67.4	0.7	0.418	211.74	146.68
RTD68T1.25	*	68.0	1.25	0.747	213.60	262.13
RTD70T2	*	70.0	2.0	1.217	219.80	427.04
RTD70T4	✓	70.0	4.0	2.363	219.80	828.96
RTD72T0.8	*	72.0	0.8	0.510	226.08	178.85
RTD72T1.25	*	72.0	1.25	0.792	226.20	277.83
RTD75T1.8	✓	75.0	1.8	1.180	235.60	413.90
RTD75T3	✓	75.0	3.0	1.933	235.50	678.24
RTD76T0.61	*	76.0	0.61	0.412	238.76	144.48
RTD76T0.72	*	76.0	0.72	0.485	238.76	170.28
RTD76T0.77	*	76.0	0.77	0.519	238.76	181.98
RTD76T0.8	*	76.0	0.8	0.538	238.64	188.90
RTD76T0.9	*	76.0	0.9	0.605	238.64	212.23
RTD76T1	*	76.0	1.0	0.671	238.64	235.50
RTD76T1.2	*	76.0	1.2	0.803	238.64	281.85
RTD76T1.4	*	76.0	1.4	0.935	238.64	327.94
RTD76T1.5	*	76.0	1.5	1.000	238.64	350.90
RTD76T4	✓	76.0	4.0	2.577	238.64	904.32

"✓" Stocked Item
 "✱" Pre-order Only Item
 (30-40 working days delivery)



Round Tubes

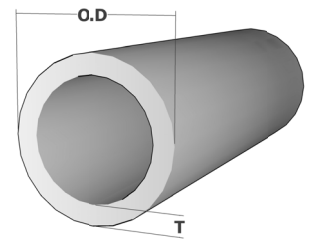

Product Code	Ex Stock	O.D (mm)	T (mm)	Mass (kg/m)	Perimeter (mm)	Area (mm ²)
RTD76T5	✱	76.0	5.0	3.179	238.64	1115.27
RTD76.2T1.3	✱	76.2	1.3	0.872	239.40	305.90
RTD80T10	✓	80.0	10.0	6.267	251.33	2199.11
RTD80T12.5	✱	80.0	12.5	7.555	251.33	2650.72
RTD80T15	✱	80.0	15.0	8.730	251.33	3063.05
RTD80T22.5	✱	80.0	22.5	11.584	251.33	4064.44
RTD80.4T1.3	✱	80.4	1.3	0.921	252.60	323.05
RTD80.6T0.8	✱	80.6	0.8	0.572	253.21	200.56
RTD84.8T1.3	✱	84.8	1.3	0.972	266.40	341.02
RTD85T12.5	✱	85.0	12.5	8.114	267.04	2847.07
RTD85T15	✱	85.0	15.0	9.401	267.04	3298.67
RTD85T17.5	✱	85.0	17.5	10.576	267.04	3711.01
RTD85T25	✱	85.0	25.0	13.430	267.04	4712.39
RTD88.9T5.3	✱	88.9	5.3	3.967	279.46	1391.98
RTD89T4	✓	89.0	4.0	3.043	279.46	1067.60
RTD89T5	✱	89.0	5.0	3.760	279.46	1319.47
RTD89.6T1.5	✱	89.6	1.5	1.183	281.50	415.16
RTD90T2	✱	90.0	2.0	1.575	282.60	552.64
RTD90T15	✱	90.0	15.0	10.073	282.74	3534.29
RTD90T17.5	✱	90.0	17.5	11.360	282.74	3985.90
RTD90T20	✱	90.0	20.0	12.535	282.74	4398.23
RTD90T27.5	✱	90.0	27.5	15.389	282.74	5399.61
RTD94T1.5	✱	94.0	1.5	1.242	295.31	435.90
RTD95T0.8	✱	95.0	0.8	0.674	298.30	236.63
RTD95T17.5	✱	95.0	17.5	12.143	298.45	4260.47
RTD95T20	✱	95.0	20.0	13.430	298.45	4712.39
RTD95T22.5	✱	95.0	22.5	14.605	298.45	5124.72
RTD95T30	✱	95.0	30.0	17.459	298.45	6126.11
RTD97T1	✱	97.0	1.0	0.860	304.74	301.59
RTD97T1.1	✱	97.0	1.1	0.944	304.58	331.24
RTD100T4	✓	100.0	4.0	3.436	314.00	1205.76
RTD100T5	✱	100.0	5.0	4.251	314.00	1491.50
RTD100T10	✓	100.0	10.0	8.058	314.16	2827.43
RTD100T20	✱	100.0	20.0	14.326	314.16	5026.55
RTD100T22.5	✱	100.0	22.5	15.613	314.16	5478.15
RTD100T25	✱	100.0	25.0	16.788	314.16	5890.49
RTD100T32.5	✱	100.0	32.5	19.642	314.16	6891.87
RTD102T0.9	✱	102.0	0.9	0.814	320.28	285.71
RTD102T1	✱	102.0	1.0	0.904	320.28	317.14
RTD102T2	✱	102.0	2.0	1.790	320.28	628.00

"✓" Stocked Item
 "*" Pre-order Only Item
 (30-40 working days delivery)



Round Tubes

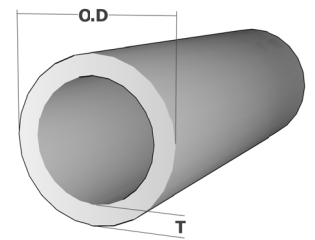

Product Code	Ex Stock	O.D (mm)	T (mm)	Mass (kg/m)	Perimeter (mm)	Area (mm ²)
RTD102T3	*	102.0	3.0	2.659	320.28	933.05
RTD108T5	*	108.0	5.0	4.609	339.12	1617.10
RTD110T10	✓	110.0	10.0	8.954	345.57	3141.59
RTD110T15	*	110.0	15.0	12.759	345.58	4476.77
RTD110T25	*	110.0	25.0	19.026	345.58	6675.88
RTD110T27.5	*	110.0	27.5	20.313	345.58	7127.49
RTD110T30	*	110.0	30.0	21.488	345.58	7539.82
RTD110T37.5	*	110.0	37.5	24.342	345.58	8541.24
RTD114.3T2.8	*	114.3	2.8	2.795	359.10	980.81
RTD115.8T1.9	*	115.8	1.9	1.938	363.80	679.87
RTD117.9T1.2	*	117.9	1.2	1.254	370.40	439.95
RTD120T2.5	*	120.0	2.5	2.629	376.80	922.38
RTD120T4	✓	120.0	4.0	4.152	376.80	1456.96
RTD120T10	✓	120.0	10.0	9.849	376.80	3455.75
RTD120T15	*	120.0	15.0	14.102	377.00	4948.00
RTD120T20	*	120.0	20.0	17.907	377.00	6283.19
RTD120T30	*	120.0	30.0	24.175	377.00	8482.30
RTD120T32.5	*	120.0	32.5	25.462	377.00	8933.90
RTD120T35	*	120.0	35.0	26.637	377.00	9346.23
RTD120T42.5	*	120.0	42.5	29.491	377.00	10347.62
RTD127T2	✓	127.0	2.0	2.237	398.78	785.00
RTD130T10	✓	130.0	10.0	10.744	408.41	3769.91
RTD130T15	*	130.0	15.0	15.445	408.41	5419.25
RTD130T20	*	130.0	20.0	19.698	408.41	6911.50
RTD130T25	*	130.0	25.0	23.503	408.41	8246.68
RTD130T35	*	130.0	35.0	29.771	408.41	10445.80
RTD130T37.5	*	130.0	37.5	31.058	408.41	10897.40
RTD130T40	*	130.0	40.0	32.233	408.41	11309.73
RTD130T47.5	*	130.0	47.5	35.087	408.41	12311.12
RTD133T5	✓	133.0	5.0	5.727	417.62	2009.60
RTD134T1.4	*	134.0	1.4	1.661	420.76	582.91
RTD134T2.4	*	134.0	2.4	2.826	420.76	991.74
RTD140T15	*	140.0	15.0	16.788	439.82	5890.49
RTD140T20	*	140.0	20.0	21.488	439.82	7539.82
RTD140T25	*	140.0	25.0	25.741	439.82	9032.10
RTD140T30	*	140.0	30.0	29.547	439.82	10367.26
RTD140T40	*	140.0	40.0	35.814	439.82	12566.37
RTD140T42.5	*	140.0	42.5	37.101	439.82	13017.97
RTD140T45	*	140.0	45.0	38.276	439.82	13430.31
RTD140T52.5	*	140.0	52.5	41.130	439.82	14431.69

"✓" Stocked Item
 "✱" Pre-order Only Item
 (30-40 working days delivery)



Round Tubes

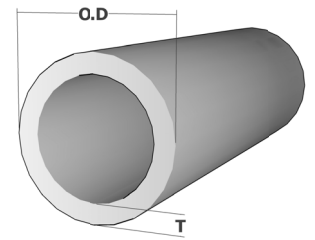

Product Code	Ex Stock	O.D (mm)	T (mm)	Mass (kg/m)	Perimeter (mm)	Area (mm ²)
RTD141T45	✱	141.0	2.0	2.489	443.00	873.36
RTD150T2	✱	150.0	2.0	2.649	471.24	929.44
RTD150T5	✓	150.0	5.0	6.488	471.24	2276.50
RTD150T10	✓	150.0	10.0	12.535	471.24	4398.23
RTD150T15	✱	150.0	15.0	18.131	471.24	6361.73
RTD150T20	✱	150.0	20.0	23.279	471.24	8168.14
RTD150T25	✱	150.0	25.0	27.980	471.24	9817.48
RTD150T30	✱	150.0	30.0	32.233	471.24	11309.73
RTD150T40	✱	150.0	40.0	39.396	471.24	13823.01
RTD159T6	✓	159.0	6.0	8.215	499.26	2882.52
RTD160T10	✓	160.0	10.0	13.430	502.65	4712.39
RTD160T15	✱	160.0	15.0	19.474	502.65	6832.96
RTD160T20	✱	160.0	20.0	25.070	502.65	8796.46
RTD160T25	✱	160.0	25.0	30.218	502.65	10602.88
RTD160T30	✱	160.0	30.0	34.919	502.65	12252.21
RTD160T35	✱	160.0	35.0	39.172	502.65	13744.47
RTD160T45	✱	160.0	45.0	46.335	502.65	16257.74
RTD162.5T38.5	✱	162.5	38.5	42.744	510.51	14997.96
RTD170T10	✱	170.0	10.0	14.326	534.07	5026.55
RTD170T15	✱	170.0	15.0	20.817	534.07	7304.20
RTD170T20	✱	170.0	20.0	26.861	534.07	9424.78
RTD170T25	✱	170.0	25.0	32.457	534.07	11388.27
RTD170T30	✱	170.0	30.0	37.605	534.07	13194.69
RTD170T35	✱	170.0	35.0	42.305	534.07	14844.03
RTD170T40	✱	170.0	40.0	46.558	534.07	16336.28
RTD170T50	✱	170.0	50.0	53.721	534.07	18849.56
RTD170.4T1.7	✱	170.4	1.7	2.568	535.33	900.98
RTD180T10	✓	180.0	10.0	15.221	565.49	5340.71
RTD180T12.5	✱	180.0	12.5	18.746	565.49	6577.71
RTD180T20	✱	180.0	20.0	28.651	565.49	10053.10
RTD180T25	✱	180.0	25.0	34.695	565.49	12173.67
RTD180T30	✱	180.0	30.0	40.291	565.49	14137.17
RTD180T35	✱	180.0	35.0	45.439	565.49	15943.58
RTD180T40	✱	180.0	40.0	50.140	565.49	17592.92
RTD180T45	✱	180.0	45.0	54.393	565.49	19085.18
RTD180T55	✱	180.0	55.0	61.556	565.49	21598.45
RTD182T15	✱	182.0	15.0	22.429	571.77	7869.69
RTD185T12.5	✱	185.0	12.5	19.306	581.20	6774.06
RTD185T15	✱	185.0	15.0	22.832	581.20	8011.06
RTD185T22.5	✱	185.0	22.5	32.736	581.20	11486.45

"✓" Stocked Item
 "✱" Pre-order Only Item
 (30-40 working days delivery)



Round Tubes

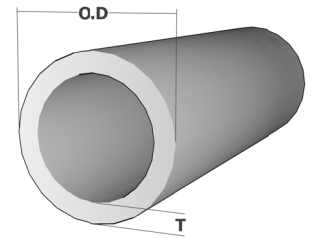

Product Code	Ex Stock	O.D (mm)	T (mm)	Mass (kg/m)	Perimeter (mm)	Area (mm ²)
RTD185T27.5	✱	185.0	27.5	38.780	581.20	13607.02
RTD185T32.5	✱	185.0	32.5	44.376	581.20	15570.52
RTD185T37.5	✱	185.0	37.5	49.524	581.20	17376.93
RTD185T42.5	✱	185.0	42.5	54.225	581.20	19026.27
RTD185T47.5	✱	185.0	47.5	58.478	581.20	20518.53
RTD185T57.5	✱	185.0	57.5	65.641	581.20	23031.80
RTD189.5T15.6	✱	189.5	15.6	24.290	595.33	8522.64
RTD220T10	✓	220.0	10.0	18.802	691.15	6597.34
RTD220T15	✱	220.0	15.0	27.532	691.15	9660.40
RTD220T20	✱	220.0	20.0	35.814	691.15	12566.37
RTD230T15	✱	230.0	15.0	28.875	722.57	10131.64
RTD230T20	✱	230.0	20.0	37.605	722.57	13196.69
RTD290T22.5	✱	290.0	22.5	53.889	911.06	18908.46
RTD300T10	✱	300.0	10.0	25.965	942.48	9110.62
RTD318T5.2	✱	318.0	5.2	15.648	999.03	5490.61
RTD320T10	✱	320.0	10.0	27.756	1005.31	9738.94

"✓" Stocked Item
 "✱" Pre-order Only Item
 (30-40 working days delivery)



Equal Angles

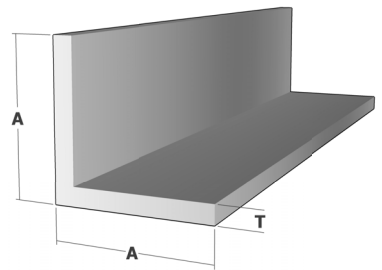

Product Code	Ex Stock	A (mm)	T (mm)	Mass (kg/m)	Perimeter (mm)	Area (mm ²)
EAA9T0.6	*	9.0	0.6	0.030	36.00	10.40
EAA10T1.6	*	10.0	1.6	0.084	40.00	29.44
EAA11T1.2	*	11.0	1.2	0.073	44.00	25.64
EAA12T1.2	*	12.0	1.2	0.078	48.00	27.36
EAA12T1.6	✓	12.0	1.6	0.102	47.00	35.70
EAA12T3	✓	12.0	3.0	0.179	47.00	62.92
EAA12.5T0.6	*	12.5	0.6	0.042	50.00	14.60
EASA15T1.2	✓	15.0	1.2	0.097	60.00	34.12
EAA16 T1.5	✓	16.0	1.5	0.130	63.00	45.60
EAA19T0.65	*	19.0	0.65	0.069	76.00	24.20
EASA19T1.5	✓	19.0	1.5	0.155	76.00	54.30
EAA19T1.9	✓	19.0	1.9	0.195	76.00	68.50
EAA20T0.8	*	20.0	0.8	0.089	80.00	31.22
EAA20T1.5	*	20.0	1.5	0.163	80.00	57.27
EAA20T1.6	✓	20.0	1.6	0.175	80.00	61.44
EASA20T3	✓	20.0	3.0	0.322	77.00	113.14
EAA22T1.1	✓	22.0	1.1	0.135	88.00	47.20
EASA25T1.4	*	25.0	1.4	0.194	100.00	68.04
EASA25T1.5	✓	25.0	1.5	0.206	100.00	72.30
EAA25T2.5	✓	25.0	2.5	0.217	79.50	76.00
EAA25T3	✓	25.0	3.0	0.400	99.00	140.52
EAA25.4T1.9	*	25.4	1.9	0.153	70.00	53.76
EASA29.5T3	*	29.5	3.0	0.473	118.00	166.00
EAA30T1	*	30.0	1.0	0.168	120.00	58.90
EAA30T1.5	✓	30.0	1.5	0.250	119.23	87.67
EAA30T2.0	*	30.0	2.0	0.331	120.00	116.00
EAA30T2.5	*	30.0	2.5	0.409	120.00	143.35
EAA30T3	✓	30.0	3.0	0.487	120.00	171.00
GM-LZY-42	✓	30.0	3.0	0.487	120.00	171.00
EASA30T3	✓	30.0	3.0	0.487	120.00	171.00
EAA30T4	✓	30.0	4.0	0.638	120.00	223.70
EAA30T4.5	*	30.0	4.5	0.712	119.00	249.67
EAA30T5.5	*	30.0	5.5	0.854	119.00	299.67
EAA35T1.5	✓	35.0	1.5	0.293	140.00	102.75
EAA37.8T1.8	*	37.8	1.8	0.378	151.00	132.80
EASA38T1.5	✓	38.0	1.5	0.317	152.00	111.30
EAA38T3	*	38.0	3.0	0.624	152.00	218.92
EAA40T1.6	✓	40.0	1.6	0.357	159.00	125.36
EAA40T2	*	40.0	2.0	0.445	160.00	156.00
EAA40T3	✓	40.0	3.0	0.658	160.00	231.00

"✓" Stocked Item
 "✱" Pre-order Only Item
 (30-40 working days delivery)



Equal Angles

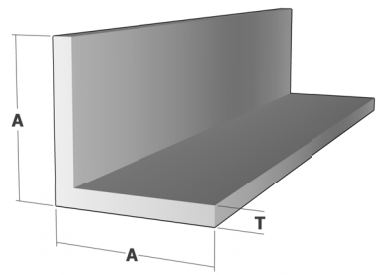

Product Code	Ex Stock	A (mm)	T (mm)	Mass (kg/m)	Perimeter (mm)	Area (mm ²)
EAA40T4	*	40.0	4.0	0.866	160.00	304.00
EAA40T6	✓	40.0	6.0	1.270	160.00	444.00
EASA40T7	*	40.0	7.0	1.448	159.00	508.23
EAA50T1.6	✓	50.0	1.6	0.449	200.00	157.44
EAA50T2	✓	50.0	2.0	0.559	200.00	196.00
EAA50T3	✓	50.0	3.0	0.829	200.00	291.00
EAA50T4	✓	50.0	4.0	1.094	200.00	384.00
EAA50T4.7	*	50.0	4.7	1.276	200.00	447.80
EAA50T6	✓	50.0	6.0	1.607	199.00	563.92
EASA55T5	*	55.0	5.0	1.511	217.00	530.27
EASA60T1.5	✓	60.0	1.5	0.507	240.00	177.75
EASA60T2	✓	60.0	2.0	0.673	240.00	236.00
EASA60T5	*	60.0	5.0	1.592	240.00	558.54
EAA60T6	✓	60.0	6.0	1.949	240.00	684.00
EAA64T15	*	64.0	15.0	4.844	253.00	1699.80
EAA65T6	✓	65.0	6.0	2.120	260.00	744.00
EAA75T3	✓	75.0	3.0	1.257	300.00	441.00
EAA75T6	✓	75.0	6.0	2.462	300.00	864.00
EAA75T12	*	75.0	12.0	4.720	300.00	1656.00
EAA100T3	✓	80.0	6.0	2.633	320.00	924.00
EAA100T6	✓	90.0	6.0	2.975	360.00	1044.00
EAA100T3	✓	100.0	3.0	1.684	400.00	591.00
EAA100T6	✓	100.0	6.0	3.317	399.00	1163.80
EAA120T10	✓	120.0	10.0	6.555	480.00	2300.00
EAA150T10	✓	150.0	10.0	8.265	599.00	2899.92
EAA200T20	*	200.0	20.0	21.660	800.00	7600.00

"✓" Stocked Item

"*" Pre-order Only Item
(30-40 working days delivery)



Unequal Angles

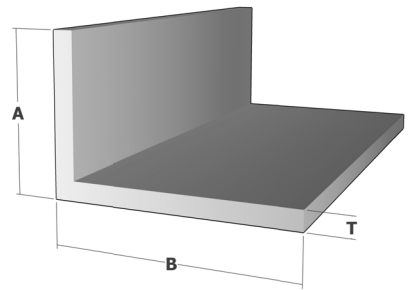

Product Code	Ex Stock	A (mm)	B (mm)	T (mm)	Mass (kg/m)	Perimeter (mm)	Area (mm ²)
UAA10B5T1	*	10.0	5.0	1.0	0.040	29.23	13.92
UAA15B10T1	*	15.0	10.0	1.0	0.068	50.00	24.00
UAA18B10T1	✓	18.0	10.0	1.0	0.077	56.00	27.00
UAA19B8T1.5	*	19.0	8.0	1.5	0.105	52.98	36.82
UAA20B11T1.5	*	20.0	11.0	1.5	0.126	62.00	44.25
UAA20B11.5T2	*	20.0	11.5	2.0	0.167	91.93	58.73
UAA20B12T1.6	✓	20.0	12.0	1.6	0.138	62.70	48.50
UAA20B12T3	✓	20.0	12.0	3.0	0.248	63.23	86.92
UAA20B14T2	*	20.0	14.0	2.0	0.182	68.00	64.00
UAA20.3B7.1T1.1	*	20.3	7.1	1.1	0.082	54.16	28.83
UAA21B20T2	*	21.0	20.0	2.0	0.220	81.14	77.20
UAA21.2B13.7T1.2	*	21.2	13.7	1.2	0.115	69.40	40.30
UAA21.6B7.8T1.6	*	21.6	7.8	1.6	0.125	57.17	43.93
UAA24B16T1.5	*	24.0	16.0	1.5	0.165	80.00	57.75
UAA25B12T1.6	✓	25.0	12.0	1.6	0.161	74.00	56.64
UAA25B12.4T2	*	25.0	12.4	2.0	0.201	73.50	70.60
UAA25B20T1.6	✓	25.0	20.0	1.6	0.198	88.70	69.30
UAA25B20T2	*	25.0	20.0	2.0	0.245	90.00	86.00
UAA25B20T3	✓	25.0	20.0	3.0	0.359	90.00	126.00
UASA29.2B17.3T2.8	*	29.2	17.3	2.8	0.307	92.20	107.80
UASA30B8.5T1.5	*	30.0	8.5	1.5	0.148	77.00	51.95
UAA30B17T2	*	30.0	17.0	2.0	0.257	94.00	90.00
UAA30B20T1.7	*	30.0	20.0	1.7	0.274	100.00	96.67
UAA30B20T2.5	✓	30.0	20.0	2.5	0.338	99.00	118.67
UAA30B25T2	✓	30.0	25.0	2.0	0.302	110.00	106.00
UAA30B25T4	*	30.0	25.0	4.0	0.581	109.23	203.92
UAA30B26T6	*	30.0	26.0	6.0	0.857	112.00	300.80
UASA33.5B25T3	✓	33.5	25.0	3.0	0.472	117.00	165.60
UAA38B11T1	*	38.0	11.0	1.0	0.137	98.00	48.00
UAA38.5B26.5T4	*	38.5	26.5	4.0	0.695	130.00	244.00
UAA38.5B26.5T8	*	38.5	26.5	8.0	1.300	130.00	456.00
UASA40B12T3	✓	40.0	12.0	3.0	0.419	104.00	147.00
UASA40B17T2	*	40.0	17.0	2.0	0.314	114.00	110.00
UASA40B20T2	✓	40.0	20.0	2.0	0.331	120.00	116.00
UASA40B25T1.5	✓	40.0	25.0	1.5	0.271	130.00	95.25
UASA40B25T3	✓	40.0	25.0	3.0	0.530	130.00	186.00
UAA40B25T2	*	40.0	25.0	2.0	0.358	130.00	125.60
UASA41B26T6	*	41.0	26.0	6.0	1.045	134.00	366.80
UASA42B22T2	*	42.0	22.0	2.0	0.351	125.85	123.00
UAA44B30T3	✓	44.0	30.0	3.0	0.627	148.00	219.90

"✓" Stocked Item
 "✱" Pre-order Only Item
 (30-40 working days delivery)



Unequal Angles

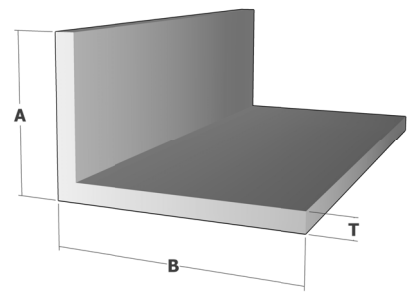

Product Code	Ex Stock	A (mm)	B (mm)	T (mm)	Mass (kg/m)	Perimeter (mm)	Area (mm ²)
UAA45B8T1.2	✱	45.0	8.0	1.2	0.177	106.00	62.10
UAA45B10T1	✱	45.0	10.0	1.0	0.154	110.00	54.00
UAA45B35T3	✱	45.0	35.0	3.0	0.658	160.00	231.00
UAA50B20T1.6	✓	50.0	20.0	1.6	0.312	140.00	109.44
UAA50B20T3	✓	50.0	20.0	3.0	0.573	140.00	201.00
UAA50B25T1.5	✓	50.0	25.0	1.5	0.314	148.70	110.00
UAA50B25T3	✓	50.0	25.0	3.0	0.615	148.70	215.80
UAA50B30T1.5	✓	50.0	30.0	1.5	0.355	159.23	117.67
UAA50B30T4	✓	50.0	30.0	4.0	0.866	160.00	304.00
UAA50B28T4	✱	50.0	28.0	4.0	0.844	156.00	296.00
UAA50B40T3	✱	50.0	40.0	3.0	0.744	180.00	261.00
UAA52B20T2	✱	52.0	20.0	2.0	0.399	144.00	140.00
UAA52B30T2	✱	52.0	30.0	2.0	0.456	164.00	160.00
UAA52B40T22	✱	52.0	40.0	22.0	4.389	184.00	1540.00
UAA55B40T4	✓	55.0	40.0	4.0	1.037	190.00	363.93
UAA60B25T3	✓	60.0	25.0	3.0	0.701	168.70	245.80
UAA60B25T4	✱	60.0	25.0	4.0	0.923	169.23	323.93
UAA60B30T2	✓	60.0	30.0	2.0	0.502	180.00	176.00
UASA60B40T10	✱	60.0	40.0	10.0	2.567	196.57	900.86
UAA60B50T4.7	✱	60.0	50.0	4.7	1.410	220.00	494.80
UAA62B32T3	✱	62.0	32.0	2.0	0.524	188.00	184.00
UAA63B25T3	✱	63.0	25.0	3.0	0.726	176.33	254.84
UAA64B25T10	✱	64.0	25.0	10.0	2.394	172.96	840.00
UAA64B25T10	✱	64.0	25.0	10.0	2.394	172.96	840.00
UAA64B25T10	✱	64.0	25.0	10.0	2.468	172.68	865.88
UAA65B25T10	✱	65.0	25.0	10.0	2.417	174.71	847.99
UAA70B25T1.5	✓	70.0	25.0	1.5	0.400	190.00	140.25
UAA70B35T3	✱	70.0	35.0	3.0	0.881	205.92	309.17
UAA70B40T5	✓	70.0	40.0	5.0	1.494	220.00	524.10
UAA70B50T4.7	✓	70.0	50.0	4.7	1.544	240.00	541.80
UAA75B25T1.5	✓	75.0	25.0	1.5	0.421	200.00	147.75
UAA75B25T3	✓	75.0	25.0	3.0	0.829	198.70	290.80
UAA75B50T3	✓	75.0	50.0	3.0	1.043	250.00	366.00
UAA75B50T6	✓	75.0	50.0	6.0	2.035	250.00	714.00
UASA80B40T10	✱	80.0	40.0	10.0	3.137	236.57	1100.86
UASA80B50T2	✱	80.0	50.0	2.0	0.730	257.94	255.97
UAA80B50T4.7	✱	80.0	50.0	4.7	1.678	260.00	588.80
UAA90B80T10.4	✱	90.0	80.0	10.4	4.730	339.23	1659.80
UAA100B25T3	✓	100.0	25.0	3.0	1.043	248.70	365.80
UAA100B50T4	✓	100.0	50.0	4.0	1.664	300.00	584.00

"✓" Stocked Item
 "✱" Pre-order Only Item
 (30-40 working days delivery)



Unequal Angles

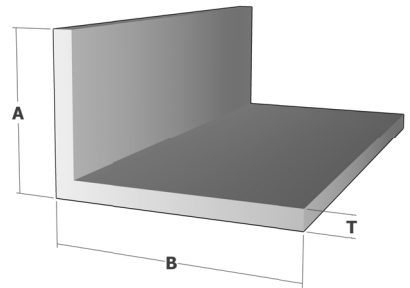

Product Code	Ex Stock	A (mm)	B (mm)	T (mm)	Mass (kg/m)	Perimeter (mm)	Area (mm ²)
UAA100B50T5	✱	100.0	50.0	5.0	2.066	299.30	725.00
UAA100B50T6	✓	100.0	50.0	6.0	2.462	299.23	863.92
UAA100B50T8	✱	100.0	50.0	8.0	3.237	300.00	1135.92
UAA100B65T6	✱	100.0	65.0	6.0	2.718	328.70	953.80
UAA100B75T8	✓	100.0	75.0	8.0	3.808	350.00	1336.00
UAA110B25T10	✱	110.0	25.0	10.0	3.563	270.00	1250.00
UASA110B70T12	✱	110.0	70.0	12.0	4.628	360.00	1624.00
UAA125B40T6	✓	125.0	50.0	8.0	3.808	350.00	1336.00
UAA130B30T1.8	✱	130.0	30.0	1.8	0.811	319.23	284.68
UAA130B50T2	✱	130.0	50.0	2.0	1.014	359.23	355.92
UAA150B50T2.5	✓	150.0	50.0	2.5	1.407	400.00	493.75
UAA150B75T6	✓	150.0	75.0	6.0	3.745	450.00	1314.00
UAA150B75T10	✱	150.0	75.0	10.0	6.127	449.23	2149.92
UAA150B100T8	✓	150.0	100.0	8.0	5.518	500.00	1936.00
UAA150B120T10	✓	150.0	120.0	10.0	7.410	540.00	2600.00
UAA200B75T10	✓	200.0	75.0	8.0	6.088	550.00	2136.00
UAA200B100T10	✓	200.0	100.0	10.0	8.265	599.23	2899.92
UAA203B50.8T10.2	✓	203.0	50.8	10.2	7.178	499.62	2518.66

"✓" Stocked Item
 "✱" Pre-order Only Item
 (30-40 working days delivery)



U Channels

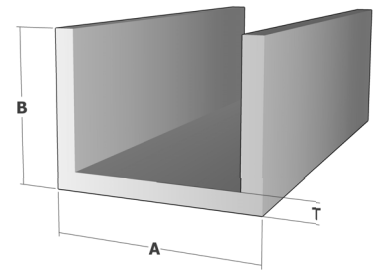

Product Code	Ex Stock	A (mm)	B (mm)	T (mm)	Mass (kg/m)	Perimeter (mm)	Area (mm ²)
CLA4.3B8T0.6	✓	4.3	8.0	0.6	0.032	38.37	11.38
CLSA5.4B22T1.5	✱	5.4	11.0	1.5	0.103	50.20	36.13
CLA7.2B9.9T1.3	✱	7.2	9.9	1.3	0.087	51.72	30.40
CLA8B9.3T0.65	✓	8.0	9.3	0.65	0.047	50.83	16.35
CLA8.7B9T0.6	✱	8.7	9.0	0.6	0.043	51.20	15.22
CLSA8.84B5T2	✱	8.84	5.0	2.0	0.070	32.48	24.53
CLA10B10T1.5	✓	10.0	10.0	1.5	0.115	56.00	40.42
CLA10B15T1.4	✱	10.0	15.0	1.4	0.148	77.2	52.08
CLA10.3B15T1.5	✱	10.3	15.0	1.5	0.159	77.6	55.95
CLA12B12T1.5	✓	12.0	12.0	1.5	0.141	68.00	49.42
CLA12B4T2	✱	12.0	4.0	2.0	0.091	36.00	32.00
CLA12B12T0.5	✱	12.0	12.0	0.5	0.045	70.20	15.75
CLA13B20T1.25	✱	13.0	20.0	1.25	0.180	103.50	63.13
CLA15.6B20T1.5	✱	15.6	20.0	1.5	0.225	108.20	78.90
CLA16B16T1.6	✓	16.0	16.0	1.6	0.204	91.10	71.50
CLA16B30T1.5	✱	16.0	30.0	1.5	0.312	149.00	109.50
CLA16B60T4.0	✱	16.0	60.0	4.0	1.479	253.88	518.87
CLA18B12T0.5	✱	18.0	12.0	0.5	0.053	82.20	18.45
CLSA19B3T1	✱	19.0	3.0	1.0	0.063	46.25	22.27
CLA19B13T0.5	✱	19.0	13.0	0.5	0.063	89.00	22.00
CLA19.6B19.6T1.3	✓	19.6	19.6	1.3	0.207	113.40	72.70
CLA20B10T1.5	✱	20.0	10.0	1.5	0.158	77.00	55.50
CLA20B20T3	✓	20.0	20.0	3.0	0.461	112.30	161.80
CLSA20B25T2.6	✓	20.0	25.0	2.6	0.497	133.00	174.30
CLSA21B21T1.5	✱	21.0	21.0	1.5	0.257	123.00	90.00
CLSA22B22T3	✓	22.0	22.0	3.0	0.513	434.13	179.92
CLSA22B60T3	✱	22.0	60.0	3.0	1.251	271.20	438.80
CLSA22.5B35T3.5	✓	22.5	35.0	3.5	0.860	174.00	301.80
CLA23B20T2	✱	23.0	20.0	2.0	0.107	40.84	37.70
CLA23B15T1	✓	23.0	15.0	1.0	0.145	102.80	51.00
CLA24B7.5T2.4	✱	24.0	7.5	2.4	0.234	72.20	82.00
CLSA24B12T1	✱	24.0	12.0	1.0	0.130	92.73	45.72
CLA25B20T1	✱	25.0	20.0	1.0	0.179	127.00	62.92
CLA25B25T3	✓	25.0	25.0	3.0	0.590	143.00	207.00
CLA25B25T1.9	✓	25.0	25.0	1.9	0.385	147.00	135.20
CLA25B50T2	✓	25.0	50.0	2.0	0.690	246.00	242.00
CLA25B50T3	✓	25.0	50.0	3.0	1.017	243.00	357.00
CLA25.5B12.8T1	✱	25.5	12.8	1.0	0.140	99.17	49.02
CLSA26B15.5T0.7	✱	26.0	15.5	0.7	0.112	111.40	39.34
CLSA28.8B35T3.5	✓	28.8	35.0	3.5	0.932	187.00	327.00

"✓" Stocked Item
 "✱" Pre-order Only Item
 (30-40 working days delivery)



U Channels

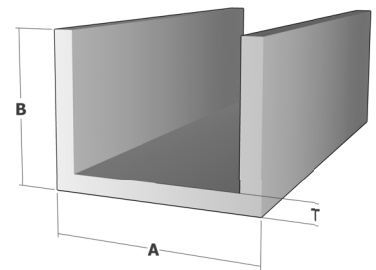

Product Code	Ex Stock	A (mm)	B (mm)	T (mm)	Mass (kg/m)	Perimeter (mm)	Area (mm ²)
CLA30B10T2	✱	30.0	10.0	2.0	0.262	96.00	92.00
CLA30B17T1.2	✱	30.0	17.0	1.2	0.239	124.60	84.00
CLA30B20T1	✱	30.0	20.0	1.0	0.194	137.00	67.92
CLA35B7.5T2.4	✱	35.0	7.5	2.4	0.309	94.20	108.40
CLSA35B9.5T3.3	✱	35.0	9.5	3.3	0.512	100.00	179.70
CLA35B13T2	✱	35.0	13.0	2.0	0.325	118.00	114.00
CLSA35B15T4	✱	35.0	15.0	4.0	0.726	117.43	254.79
CLA35.5B17T3	✱	35.5	17.0	3.0	0.543	131.87	190.42
CLA36B36T2.5	✓	36.0	36.0	2.5	0.733	209.30	257.30
CLSA36.2B11.9T2	✱	36.2	11.9	2.0	0.319	115.20	111.92
CLA38.2B12.8T1	✱	38.2	12.8	1.0	0.177	124.20	62.00
CLA40B11.5T2	✱	40.0	11.5	2.0	0.335	120.71	117.68
CLA40B15T3	✓	40.0	15.0	3.0	0.547	132.28	191.79
CLSA40B19T4	✱	40.0	19.0	4.0	0.787	144.14	276.03
CLA40B20T1.6	✱	40.0	20.0	1.6	0.350	155.77	122.80
CLA40B25T3	✓	40.0	25.0	3.0	0.718	172.30	251.80
CLSA41B45T3	✱	41.0	45.0	3.0	1.035	252.65	363.00
CLA44B50T4	✓	44.0	50.0	4.0	1.550	278.30	543.80
CLA44B50T6	✱	44.0	50.0	6.0	2.230	270.94	782.57
CLA45B8T1.2	✱	45.0	8.0	1.2	0.200	118.60	70.20
CLA45.5B27T5	✱	45.5	27.0	5.0	1.275	188.00	447.42
CLA46B20T2	✱	46.0	20.0	2.0	0.467	168.00	164.00
CLA46B27T5	✱	46.0	27.0	5.0	1.282	189.00	449.92
CLA46.5B27T4.5	✱	46.5	27.0	4.5	1.173	191.00	411.67
CLSA46.6B22.5T3	✱	46.6	22.5	3.0	0.729	177.00	255.71
CLA48B19T1	✱	48.0	18.8	1.0	0.247	168.28	86.79
CLA48B75T8	✱	48.0	75.0	8.0	4.150	380.00	1456.00
CLA48.5B18.8T1	✱	48.5	18.8	1.0	0.239	168.92	83.89
CLA48.5B24.5T1.7	✱	48.5	24.5	1.7	0.400	188.94	140.20
CLA49.5B38T3	✱	49.5	38.0	3.0	1.021	243.97	358.42
CLSA50B9T3	✱	50.0	9.0	3.0	0.529	128.37	185.53
CLA50B10T3	✱	50.0	10.0	3.0	0.547	133.00	191.90
CLA50B15T3	✓	50.0	15.0	3.0	0.633	154.00	222.00
GM-NZJUN-012	✓	50.0	25.0	3.0	0.793	191.50	278.30
CLSA50B25T3	✓	50.0	25.0	3.0	0.803	193.00	281.90
CLA50B30T4	✱	50.0	30.0	4.0	1.163	212.00	408.00
CLSA50B36T6	✱	50.0	36.0	6.0	1.730	228.57	606.87
CLSA50B50T3	✱	50.0	50.0	3.0	1.219	292.40	427.80
CLA50B50T3	✓	50.0	50.0	3.0	1.231	292.96	431.92
CLA50.6B20T1	✱	50.6	20.0	1.0	0.252	177.92	88.39

"✓" Stocked Item
 "✱" Pre-order Only Item
 (30-40 working days delivery)



U Channels

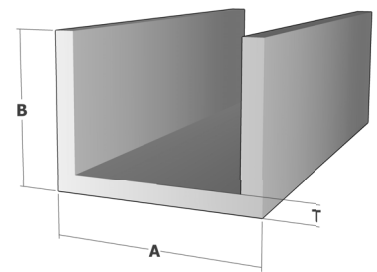

Product Code	Ex Stock	A (mm)	B (mm)	T (mm)	Mass (kg/m)	Perimeter (mm)	Area (mm ²)
CLA51B13T1	*	51.0	13.0	1.0	0.213	151.00	74.80
CLA51.1B20T1	*	51.1	20.0	1.0	0.253	178.95	88.91
CLA51.4B110T4	*	51.4	110.0	4.0	3.004	534.00	1054.00
CLSA51.8B25T0.9	*	51.8	25.0	0.9	0.258	201.20	90.50
CLSA55B30T3	*	55.0	30.0	3.0	0.929	221.40	326.00
CLA56B27T4.5	*	56.0	27.0	4.5	1.295	210.00	454.42
CLA56B27T5	*	56.0	27.0	5.0	1.425	209.00	499.92
CLA57B15T3	✓	57.0	15.0	3.0	0.693	168.00	243.00
CLA58B20T2	*	58.0	20.0	2.0	0.536	192.00	188.00
CLA58B65T3.5	✓	58.0	65.0	3.5	1.873	367.42	657.10
CLSA69B59T4	*	59.0	69.0	4.0	2.128	383.90	746.70
CLA60B40T3.5	*	60.0	40.0	3.5	1.351	263.56	473.87
CLA60B70T4	*	60.0	70.0	4.0	2.189	392.00	768.00
CLA60B110T4	*	60.0	110.0	4.0	3.101	559.00	1088.00
CLSA61B150T5	*	61.0	150.0	5.0	4.480	705.50	1571.98
CLA65B25T4	✓	65.0	25.0	4.0	1.220	222.00	428.00
CLA65B40T10	*	65.0	40.0	10.0	3.809	259.13	1336.57
CLA68B19T1	*	68.0	19.0	1.0	0.296	209.00	103.92
CLA70B12T1	*	70.0	12.0	1.0	0.308	217.00	107.92
CLA70B20T1	*	70.0	20.0	1.0	0.308	217.00	107.92
CLA75B25T3	✓	75.0	25.0	3.0	1.017	242.30	356.80
CLA75B40T3	✓	75.0	40.0	3.0	1.273	302.30	446.80
CLA76.5B12.8T1.1	*	76.5	12.8	1.1	0.312	200.50	109.6
CLA80B36T5	*	80.0	36.0	5.0	2.028	291.51	711.60
CLSA80B39.8T3.9	*	80.0	39.8	3.9	1.701	305.39	596.96
CLA80B30T2	*	80.0	30.0	2.0	0.778	276.00	272.97
CLA80B40T3	✓	80.0	40.0	3.0	1.317	314.00	462.00
CLA80B40T5	✓	80.0	40.0	5.0	2.137	308.97	749.92
CLSA90B75T13	*	90.0	75.0	13.0	6.888	450.57	2416.87
CLA100B25T3	✓	100.0	25.0	3.0	1.231	292.30	431.80
CLA100B50T5	✓	100.0	50.0	5.0	2.707	388.97	949.92
CLSA100B60T5.5	*	100.0	60.0	5.5	3.429	426.00	1203.00
CLSA100B85T1.7	*	100.0	85.0	1.7	1.158	478.96	406.31
CLA100B100T5	*	100.0	100.0	5.0	4.133	589.00	1450.00
CLA101.6B12.8T1.1	*	101.6	12.8	1.1	0.391	251.00	137.20
CLSA104B45T8	*	104.0	45.0	8.0	4.269	372.00	1498.00
CLA108B48T2.6	*	108.0	48.0	2.6	1.473	401.80	516.80
CLA110B15T3	*	110.0	15.0	3.0	1.148	272.28	402.79
CLA116B40.5T5	*	116.0	40.5	5.0	2.555	382.51	896.50
CLSA120B85T1.7	*	120.0	85.0	1.7	1.255	518.95	440.31

"✓" Stocked Item
 "✱" Pre-order Only Item
 (30-40 working days delivery)



U Channels

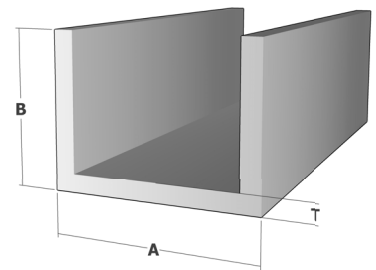

Product Code	Ex Stock	A (mm)	B (mm)	T (mm)	Mass (kg/m)	Perimeter (mm)	Area (mm ²)
CLSA127B69.85T4.83	*	127.0	69.85	4.83	4.879	514.56	1711.77
CLSA150B61T5	✓	150.0	61.0	5.0	3.734	540.00	1310.00
CLSA150B65T6.5	*	150.0	65.0	6.5	5.068	537.64	1778.30
CLA150B75T5	✓	150.0	75.0	5.0	4.132	588.30	1449.80
CLA152.4B82.6T5.33	*	152.4	82.6	5.33	6.299	617.80	2210.19
CLA153B74T19	*	153.0	74.0	19.0	14.229	558.85	4992.71
CLSA170B100T6	*	170.0	100.0	6.0	6.048	719.42	2122.25
CLA180B52T15	*	180.0	52.0	15.0	10.859	538.00	3810.00
CLA180B120T15	*	180.0	120.0	15.0	16.673	810.00	5850.00
CLSA180B120T15	*	180.0	120.0	15.0	15.421	811.71	5410.73
CLSA200B70T10	*	200.0	70.0	10.0	9.242	651.42	3242.92
CLSA203.2B95.3T6.35	*	203.2	95.3	6.35	9.049	767.07	3175.14
CLSA254B88.9T6.35	*	254.0	88.9	6.35	9.592	843.30	3365.51
CLSA280B53T11	*	280.0	53.0	11.0	10.258	744.85	3599.45
CLSA280B53T21	*	280.0	53.0	21.0	18.067	742.85	6339.45
CLSA300B100T7	*	300.0	100.0	7.0	9.696	986.00	3402.00

"✓" Stocked Item
 "✱" Pre-order Only Item
 (30-40 working days delivery)



Flat Bars

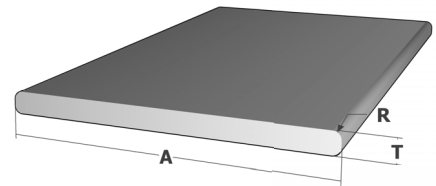

Product Code	Ex Stock	A (mm)	T (mm)	R (mm)	Mass (kg/m)	Perimeter (mm)	Area (mm ²)
FBRA6.9T4.9R2.5	*	6.9	4.9	2.5	0.082	19.40	28.70
FBA7.5T2	*	7.5	2.0		0.043	19.00	15.00
FBA8T4	*	8.0	4.0		0.091	24.00	32.00
FBA10T2	*	10.0	2.0		0.057	24.00	20.00
FBA10T3	✓	10.0	3.0		0.086	26.00	30.00
FBA10T6	✓	10.0	6.0		0.171	32.00	60.00
FBA11.4T4.4	*	11.4	4.4		0.143	31.60	50.16
FBA12T3	✓	12.0	3.0		0.103	30.00	36.00
FBA13T6	*	13.0	6.0		0.222	38.00	78.00
FBA15T1.6	*	15.0	1.6		0.068	33.20	24.00
FBA15T2	✓	15.0	2.0		0.085	33.50	29.90
FBRA15T2.7R1	*	15.0	2.7	1.0	0.113	33.70	39.64
FBA15T4	*	15.0	4.0		0.170	37.14	59.79
FBA16T3	✓	16.0	3.0		0.136	37.20	47.80
FBRA16T4R4.7	*	16.0	4.0	4.7	0.180	38.18	62.76
FBA18T1.8	*	18.0	1.8		0.092	39.60	32.40
FBA19T1.2	*	19.0	1.2		0.062	42.00	21.89
FBA19T2	✓	19.0	2.0		0.108	42.00	38.00
FBA19T3	*	19.0	3.0		0.162	44.00	57.00
FBRA19T5R1	*	19.0	5.0	1.0	0.268	46.28	94.14
FBA20T1.5	✓	20.0	1.5		0.086	42.50	30.00
FBA20T2	*	20.0	2.0		0.114	44.00	40.00
FBA20T2.5	*	20.0	2.5		0.143	45.00	50.00
FBA20T2.8	✓	20.0	2.8		0.160	45.60	56.00
FBA20T3	*	20.0	3.0		0.171	46.00	60.00
FBA20T5	*	20.0	5.0		0.285	50.00	100.00
FBA23T4	*	23.0	4.0		0.262	54.00	92.00
FBA20T10	*	20.0	10.0		0.570	60.00	200.00
FBA23T10	*	23.0	10.0		0.656	66.00	230.00
FBA25T1.5	*	25.0	1.5		0.107	53.00	37.50
FBA25T2	*	25.0	2.0		0.143	54.00	50.00
FBA25T2.5	✓	25.0	2.5		0.178	55.00	62.50
FBA25T3	✓	25.0	3.0		0.214	55.50	74.92
FBA25T4	*	25.0	4.0		0.285	58.40	99.90
FBA25T5	✓	25.0	5.0		0.356	60.00	125.00
FBA25T10	✓	25.0	10.0		0.713	70.00	250.00
FBA25T20	*	25.0	20.0		1.425	90.00	500.00
FBA28T1.5	*	28.0	1.5		0.119	58.50	41.90
FBA28T3	*	28.0	3.0		0.239	62.00	84.00
FBA28T5.8	*	28.0	5.8		0.462	66.74	162.20

"✓" Stocked Item
 "✱" Pre-order Only Item
 (30-40 working days delivery)



Flat Bars

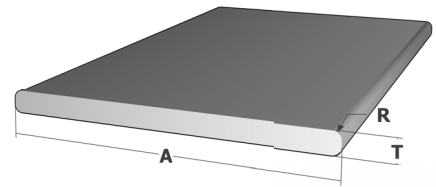

Product Code	Ex Stock	A (mm)	T (mm)	R(mm)	Mass (kg/m)	Perimeter (mm)	Area (mm ²)
FBA28T8	*	28.0	8.0		0.638	71.14	223.80
FBA28T14	*	28.0	14.0		1.117	83.14	391.80
FBA28.3T2	*	28.3	2.0		0.161	60.60	56.60
FBA29.5T3.9	*	29.5	3.9		0.328	66.80	115.05
FBA30T1.2	*	30.0	1.2		0.092	61.26	32.74
FBA30T2	*	30.0	2.0		0.171	64.00	60.00
FBA30T2.5	*	30.0	2.5		0.214	65.00	75.00
FBA30T3	✓	30.0	3.0		0.257	66.00	90.00
FBRA30T3R1	*	30.0	3.0	1.0	0.254	64.28	89.14
FBA30T4.8	✓	30.0	4.8		0.410	69.60	144.00
FBSA30T5	✓	30.0	5.0		0.428	70.00	150.00
FBRSA32T22R3	*	32.0	22.0	3.0	1.995	105.00	700.03
FBRA34.5T3.8R1	*	34.5	3.8	1.0	0.374	76.60	131.10
FBA35T5	✓	35.0	5.0		0.499	80.00	175.00
FBRA35T5R1	✓	35.0	5.0	1.0	0.496	78.28	174.14
FBA35T20	*	35.0	20.0		2.000	110.00	700.00
FBRA37.6T5.5R2.7	*	37.6	5.5	2.7	0.571	82.00	200.30
FBA38T10	*	38.0	10.0		0.669	207.27	234.74
FBA38T13	*	38.0	13.0		1.408	102.00	494.00
FBRA38.1T3R1.5	✓	38.1	3.0	1.5	0.326	82.20	114.30
FBRA38.1T6.3R3.1	✓	38.1	6.3	3.1	0.684	88.80	240.03
FBA40T0.9	*	40.0	0.9		0.103	81.80	36.00
FBA40T1.5	*	40.0	1.5		0.171	82.50	59.92
FBA40T2.9	✓	40.0	2.9		0.331	85.80	116.00
FBRA40T5R2.5	*	40.0	5.0	2.5	0.555	85.70	194.60
GLX-4532	✓	40.0	5.0		0.570	90.00	200.00
FBA40T6	✓	40.0	6.0		0.684	92.00	240.00
FBA40T8.2	*	40.0	8.2		0.935	96.40	328.00
FBA40T10	✓	40.0	10.0		1.140	100.00	400.00
FBA40T15	✓	40.0	15.0		1.710	110.00	600.00
FBA45T10	✓	45.0	10.0		1.282	110.00	449.92
FBA45T42	*	45.0	42.0		5.387	174.00	1890.00
FBA45.2T3.2	*	45.2	3.2		0.412	96.80	144.64
FBA46T2	*	46.0	2.0		0.262	96.00	92.00
FBA47.5T1.3	✓	47.5	1.3		0.176	97.60	61.75
FBA47.6T1.5	*	47.6	1.5		0.203	97.70	71.32
FBRA49T5R2.5	*	49.0	5.0	2.5	0.695	108.00	245.00
FBRA50T3R1.5	*	50.0	3.0	1.5	0.428	106.00	150.00
FBA50T3	✓	50.0	3.0		0.428	106.00	150.00
FBA50T3.5	*	50.0	3.5		0.500	107.00	175.00

"✓" Stocked Item
 "✱" Pre-order Only Item
 (30-40 working days delivery)



Flat Bars

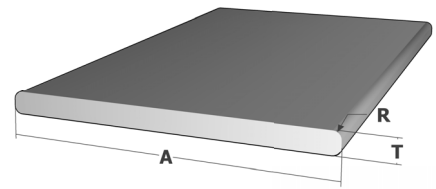

Product Code	Ex Stock	A (mm)	T (mm)	R(mm)	Mass (kg/m)	Perimeter (mm)	Area (mm ²)
FBA50T4	*	50.0	4.0		0.570	108.00	200.00
FBA50T5	*	50.0	5.0		0.713	110.00	250.00
FBA50T6	✓	50.0	6.0		0.855	112.00	300.00
FBRA50T6R3	*	50.0	6.0	3.0	0.855	112.00	300.00
FBA50T10	✓	50.0	10.0		1.425	120.00	500.00
FBA50T12	✓	50.0	12.0		1.710	124.00	600.00
FBA50T20	✓	50.0	20.0		2.850	140.00	1000.00
FBA50T25	✓	50.0	25.0		3.563	150.00	1250.00
FBA55T1.7	*	55.0	1.7		0.266	113.40	93.50
FBSA55T5	*	55.0	5.0		0.784	120.00	275.00
FBSA55T8	*	55.0	8.0		1.254	125.50	439.92
FBA56.5T27	*	56.5	27.0		4.344	164.77	1524.05
FBA57.6T2.8	*	57.6	2.8		0.460	120.80	161.28
FBA58T4	*	58.0	4.0		0.661	124.00	232.00
FBA60T0.9	*	60.0	0.9		0.154	121.80	54.00
FBA60T3	✓	60.0	3.0		0.512	125.20	179.80
FBA60T4	*	60.0	4.0		0.684	128.00	240.00
FBA60T5	✓	60.0	5.0		0.855	130.00	300.00
FBA60T6	✓	60.0	6.0		1.026	132.00	360.00
FBA60T10	✓	60.0	10.0		1.710	140.00	600.00
FBA60T12	✓	60.0	12.0		2.052	144.00	720.00
FBRA64T5R2.5	*	64.0	5.0	2.5	0.911	135.70	319.60
FBA65T8	*	65.0	8.0		1.482	146.00	520.00
FBA70T2	*	70.0	2.0		0.399	144.00	140.00
FBA70T4	*	70.0	4.0		0.789	147.50	279.92
FBA70T10	✓	70.0	10.0		1.995	160.00	700.00
FBA70T15	*	70.0	15.0		2.993	170.00	1050.00
FBA75T2	✓	75.0	2.0		0.428	154.00	150.00
FBA75T4	✓	75.0	4.0		0.855	158.00	300.00
FBA75T6	✓	75.0	6.0		1.283	162.00	450.00
FBA75T10	✓	75.0	10.0		2.138	170.00	750.00
FBA75T12	✓	75.0	12.0		2.565	174.00	900.00
FBA75T20	✓	75.0	20.0		4.275	190.00	1500.00
FBA77T6	*	77.0	6.0		1.317	165.50	462.00
FBA80T6	✓	80.0	6.0		1.368	172.00	480.00
FBA80T10	✓	80.0	10.0		2.280	180.00	800.00
FBA80T12	✓	80.0	12.0		2.736	184.00	960.00
FBA84T4	*	84.0	4.0		0.958	176.00	336.00
FBA84T5	*	84.0	5.0		1.197	177.48	419.92
FBA84T6	*	84.0	6.0		1.436	180.00	504.00

"✓" Stocked Item
 "✱" Pre-order Only Item
 (30-40 working days delivery)



Flat Bars

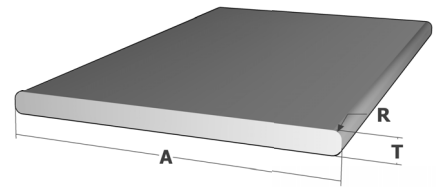

Product Code	Ex Stock	A (mm)	T (mm)	R (mm)	Mass (kg/m)	Perimeter (mm)	Area (mm ²)
FBA88T5	*	88.0	5.0		1.254	185.50	440.00
FBA90T3	✓	90.0	3.0		0.769	185.50	269.92
FBRA90T5R2.5	✓	90.0	5.0	2.5	1.267	185.70	444.60
FBRA90T6R3	✓	90.0	6.0	3.0	1.517	186.90	532.30
FBA95T3.5	*	95.0	3.5		0.950	197.00	332.40
FBA96T6	*	96.0	6.0		1.950	204.00	576.00
FBA100T1.5	*	100.0	1.5		0.430	203.00	150.00
FBA100T3	✓	100.0	3.0		0.855	206.00	300.00
FBA100T3	*	100.0	4.0		1.140	208.00	400.00
FBA100T6	✓	100.0	6.0		1.709	211.20	599.80
FBA100T8	*	100.0	8.0		2.280	216.00	800.00
FBA100T10	✓	100.0	10.0		2.850	220.00	1000.00
FBRA100T10R5	*	100.0	10.0	5.0	2.789	211.42	978.54
FBA100T12	✓	100.0	12.0		3.420	224.00	1200.00
FBA106T6	*	106.0	6.0		1.813	224.00	636.00
FBA110T2	*	110.0	2.0		0.627	224.00	220.00
FBA110T8	✓	110.0	8.0		2.508	236.00	880.00
FBA116T6	*	116.0	6.0		1.984	224.00	696.00
FBA117T3.7	*	117.0	3.7		1.234	241.40	432.90
FBRA119T5R2.5	*	119.0	5.0	2.5	1.682	243.70	590.00
FBA120T6	✓	120.0	6.0		2.052	252.00	720.00
FBRA120T6R3	✓	120.0	6.0	3.0	2.030	246.90	712.30
FBA120T8	*	120.0	8.0		2.736	256.00	960.00
FBA120T12	*	120.0	12.0		4.104	264.00	1440.00
FBA123T4.8	*	123.0	4.8		1.683	255.60	590.40
FBA123T5.5	*	123.0	5.5		1.928	257.00	676.50
FBA123T3.5	*	123.0	3.5		1.227	253.00	430.50
FBA125T6	✓	125.0	6.0		2.138	262.00	750.00
FBA125T10	✓	125.0	10.0		3.563	270.00	1250.00
FBA125T12	✓	125.0	12.0		4.275	274.00	1500.00
FBA126T6	*	126.0	6.0		2.155	264.00	756.00
FBA133.5T6	*	133.5	6.0		2.283	279.00	801.00
FBA136T4	*	136.0	4.0		1.550	280.00	544.00
FBA136T6	*	136.0	6.0		2.326	284.00	816.00
FBA138T5.8	✓	138.0	5.8		2.281	287.60	800.40
FBRA140T5.9R2.9	*	140.0	5.9	2.9	2.333	286.70	818.50
FBA140T10	*	140.0	10.0		3.990	300.00	1400.00
FBA142T3.6	*	142.0	3.6		1.457	291.20	511.20
FBA143T25	*	143.0	25.0		10.189	336.00	3575.00
FBA145T6	✓	145.0	6.0		2.480	302.00	870.00

"✓" Stocked Item
 "✱" Pre-order Only Item
 (30-40 working days delivery)



Flat Bars

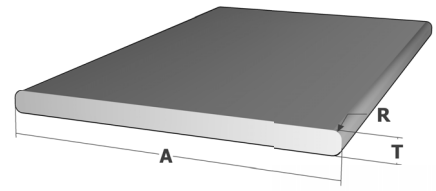

Product Code	Ex Stock	A (mm)	T (mm)	R (mm)	Mass (kg/m)	Perimeter (mm)	Area (mm ²)
FBA150T3	✓	150.0	3.0		1.283	306.00	450.00
FBA150T5	✓	150.0	5.0		2.138	310.00	750.00
FBA150T8	✱	150.0	8.0		3.420	316.00	1200.00
FBA150T10	✓	150.0	10.0		4.275	319.50	1500.00
FBA150T13.5	✓	150.0	13.5		5.771	327.00	2025.00
FBA151T3.2	✱	151.0	3.2		1.377	308.40	483.20
FBA151T4.8	✱	151.0	4.8		2.066	311.60	724.80
FBA151T5.8	✱	151.0	5.8		2.496	313.60	875.80
FBA151T3.7	✱	151.0	3.7		1.592	309.40	558.70
FBRA160T5.9R2.9	✱	160.0	5.9	2.9	2.670	427.00	937.00
FBA160T10	✓	160.0	10.0		4.560	340.00	1600.00
FBA160T20	✱	160.0	20.0		9.120	360.00	3200.00
FBA160T25	✱	160.0	25.0		11.400	370.00	4000.00
FBA160T27	✱	160.0	27.0		12.466	378.00	4374.00
FBA200T5	✓	200.0	5.0		2.850	410.00	1000.00
FBA200T10	✓	200.0	10.0		5.700	420.00	2000.00
FBA200T11	✓	200.0	11.0		6.270	422.00	2200.00
FBRA209T5.9R2.9	✱	209.0	5.9	2.9	3.493	424.70	1225.60
FBA220T5	✓	220.0	5.0		3.135	450.00	1100.00
FBA222T1.8	✱	222.0	1.8		1.139	447.60	399.60
FBA270T6	✱	270.0	6.0		4.617	552.00	1620.00
FBA270T9	✓	270.0	9.0		6.926	558.00	2430.00
FBA270T14	✱	270.0	14.0		10.773	568.00	3780.00
FBA300T4	✱	300.0	4.0		3.420	608.00	1200.00
FBA300T10	✓	300.0	10.0		8.550	619.50	2999.92

"✓" Stocked Item
 "✱" Pre-order Only Item
 (30-40 working days delivery)



Tee Bars

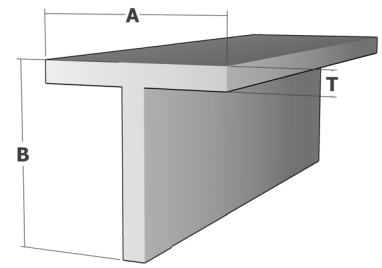

Product Code	Ex Stock	A (mm)	B (mm)	T (mm)	Mass (kg/m)	Perimeter (mm)	Area (mm ²)
TBA15B15T1.5	✱	15.0	15.0	1.5	0.122	60.00	42.75
TBA15B80T3	✱	15.0	80.0	3.0	0.787	190.00	276.00
TBA19B19T3.2	✓	19.0	19.0	3.2	0.316	76.71	110.89
TBA15B35T1.1	✱	15.0	35.0	1.1	0.153	98.97	53.71
TBA20B10T1.5	✓	20.0	10.0	1.5	0.122	59.00	42.68
TBA20B11.5T4	✓	20.0	11.5	4.0	0.292	62.00	102.42
TBA20B20T1.5	✓	20.0	20.0	1.5	0.165	80.00	57.75
TBSA22.8B42.7T1	✱	22.8	42.7	1.0	0.189	129.37	66.35
TBA25B25T3	✓	25.0	25.0	3.0	0.401	98.30	140.80
TBSA30B40T4	✱	30.0	40.0	4.0	0.763	137.44	267.86
TBSA35.8B68T2.8	✱	35.8	68.0	2.8	1.139	231.00	399.50
TBSA35.8B78T2.8	✱	35.8	78.0	2.8	1.269	253.80	445.30
TBSA35.8B88T2.8	✱	35.8	88.0	2.8	1.400	277.00	491.20
TBSA35.8B98T2.8	✱	35.8	98.0	2.8	1.530	300.00	537.00
TBSA37B53.7T3.7	✱	37.0	53.7	3.7	0.908	184.00	318.76
TBA40B20T1.5	✓	40.0	20.0	1.5	0.250	118.30	87.60
TBA40B40T3	✓	40.0	40.0	3.0	0.658	158.30	230.80
TBA40B40T6	✓	40.0	40.0	6.0	1.265	158.30	443.80
TBA40B50T6	✓	40.0	50.0	6.0	1.436	178.30	503.80
TBSA41B32T1.5	✓	41.0	32.0	1.5	0.353	143.00	123.90
TBSA45B25T2.5	✱	45.0	25.0	2.5	0.481	139.23	168.63
TBA50B50T3	✓	50.0	50.0	3.0	0.829	199.00	290.92
TBA50B50T6	✓	50.0	50.0	6.0	1.607	198.30	563.80
TBA50B100T6	✓	50.0	100.0	6.0	2.462	298.30	863.80
TBA51B62T16.7	✱	51.0	62.0	16.7	4.207	225.15	1476.17
TBA55B55T3	✱	55.0	55.0	3.0	0.915	220.00	321.00
TBSA60B30T4.5	✱	60.0	30.0	4.5	1.351	179.00	473.92
TBSA60B30T5.5	✱	60.0	30.0	5.5	1.499	179.00	525.92
TBSA60B60T6	✓	60.0	60.0	6.0	1.949	240.00	684.00
TBA60B70T2	✱	60.0	70.0	2.0	0.729	259.00	255.92
TBA63.5B63.5T6.35	✓	63.5	63.5	6.35	2.183	252.30	766.00
TBA65B123T2.2	✓	65.0	123.0	2.2	1.125	373.08	394.86
TBA75B75T6	✓	75.0	75.0	6.0	2.462	298.30	863.80
TBA101B60T4	✱	101.0	60.0	4.0	1.809	318.57	634.87
TBA120B84T4	✱	120.0	84.0	4.0	2.280	406.97	800.00
TBA150B100T8	✓	150.0	100.0	8.0	5.518	500.00	1936.00

"✓" Stocked Item
 "✱" Pre-order Only Item
 (30-40 working days delivery)



Solid Rounds

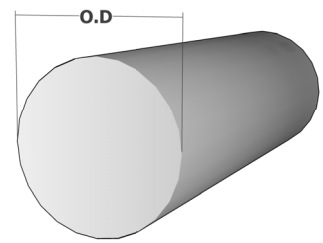

Product Code	Ex Stock	O.D (mm)	Mass (kg/m)	Perimeter (mm)	Grade & Temper
SRD4.4L3	*	4.4	0.043	13.82	6061-T6
SRD5L3	*	5.0	0.056	15.71	6061-T6
SRD5.3L3	*	5.3	0.063	16.65	6061-T6
SRD6L3	*	6.0	0.081	18.90	6061-T6
SRD6.3L3	✓	6.3	0.089	19.79	6061-T6
SRD6.8L3	*	6.8	0.104	21.36	6061-T6
SRD7L3	✓	7.0	0.110	21.99	6061-T6
SRD8L3	✓	8.0	0.143	25.13	6061-T6
SRD9.53L3	✓	9.53	0.203	30.00	6061-T6
SRD9.7L3	*	9.7	0.211	30.50	6061-T6
SRD10L3	*	10.0	0.224	31.42	6061-T6
SRD10.5L3	*	10.5	0.247	32.99	6061-T6
SRD11L3	✓	11.0	0.271	34.56	6061-T6
SRD11.8L3	*	11.8	0.312	37.10	6061-T6
SRD12L3	*	12.0	0.322	37.70	6061-T6
SRD12.7L3	✓	12.7	0.361	40.00	6061-T6
SRD13L3	*	13.0	0.378	40.84	6061-T6
SRD14L3	*	14.0	0.439	44.00	6061-T6
SRD15L3	✓	15.0	0.504	47.12	6061-T6
SRD15.6L3	*	15.6	0.545	49.00	6061-T6
SRD16L3	✓	16.0	0.573	50.27	6061-T6
SRD17L3	*	17.0	0.647	53.40	6061-T6
SRD18L3	✓	18.0	0.725	56.55	6061-T6
SRD19L3	✓	19.0	0.808	59.70	6061-T6
SRD20L3	✓	20.0	0.895	62.80	6061-T6
SRD21L3	*	21.0	0.987	66.00	6061-T6
SRD22L3	✓	22.0	1.083	69.12	6061-T6
SRD23L3	*	23.0	1.184	72.26	6061-T6
SRD24L3	✓	24.0	1.289	75.40	6061-T6
SRD25L3	*	25.0	1.399	78.54	6061-T6
SRD25.4L3	✓	25.4	1.444	79.80	6061-T6
SRD26L3	*	26.0	1.513	81.70	6061-T6
SRD26.2L3	*	26.2	1.537	82.31	6061-T6
SRD26.5L3	✓	26.5	1.572	83.25	6061-T6
SRD27L3	✓	27.0	1.623	84.80	6061-T6
SRD28L3	*	28.0	1.755	88.00	6061-T6
SRD29L3	✓	29.0	1.882	91.11	6061-T6
SRD32L3	✓	32.0	2.292	100.53	6061-T6
SRD33L3	*	33.0	2.438	103.67	6061-T6
SRD34L3	*	34.0	2.588	106.81	6061-T6

"✓" Stocked Item
 "✱" Pre-order Only Item
 (30-40 working days delivery)



Solid Rounds

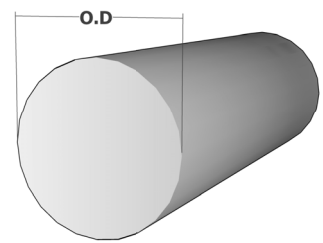

Product Code	Ex Stock	O.D (mm)	Mass (kg/m)	Perimeter (mm)	Grade & Temper
SRD35L3	✱	35.0	2.742	109.96	6061-T6
SRD36L3	✱	36.0	2.901	113.10	6061-T6
SRD37.5L3	✱	37.5	3.148	117.81	6061-T6
SRD38.1L3	✓	38.1	3.249	119.70	6061-T6
SRD39.5L3	✱	39.5	3.492	124.10	6061-T6
SRD40L3	✓	40.0	3.581	125.66	6061-T6
SRD41.28L3	✓	41.28	3.814	129.70	6061-T6
SRD42L3	✱	42.0	3.949	131.95	6061-T6
SRD42.8L3	✱	42.8	4.100	134.46	6061-T6
SRD44.5L3	✓	44.5	4.423	139.70	6061-T6
SRD47.7L3	✱	47.7	5.093	149.90	6061-T6
SRD50L3	✱	50.0	5.596	157.08	6061-T6
SRD50.8L3	✓	50.8	5.777	159.60	6061-T6
SRD54L3	✓	54.0	6.527	169.70	6061-T6
SRD55L3	✓	55.0	6.771	172.79	6061-T6
SRD59.9L3	✓	59.9	8.031	188.18	6061-T6
SRD60.32L3	✓	60.32	8.144	189.50	6061-T6
SRD64L3	✓	64.0	9.168	201.10	6061-T6
SRD65L3	✓	65.0	9.457	204.20	6061-T6
SRD69.5L3	✓	69.5	10.812	177.12	6061-T6
SRD70L3	✓	70.0	10.968	219.91	6061-T6
SRD76.2L3	✓	75.0	12.315	239.39	6061-T6
SRD80L3	✓	80.0	14.326	251.33	6061-T6
SRD85L3	✓	85.0	16.172	267.04	6061-T6
SRD90L3	✓	90.0	16.820	279.29	6061-T6
SRD95L3	✓	95.0	20.201	298.45	6061-T6
SRD100L3	✓	100.0	22.384	314.16	6061-T6
SRD105L3	✓	105.0	24.678	329.87	6061-T6
SRD110L3	✓	110.0	27.084	345.58	6061-T6
SRD115L3	✓	115.0	29.603	361.28	6061-T6
SRD120L3	✓	120.0	32.233	376.99	6061-T6
SRD125L3	✓	125.0	34.975	392.70	6061-T6
SRD127L3	✓	127.0	34.210	398.98	6061-T6
SRD150L3	✓	150.0	49.260	478.78	6061-T6
SRD165L3	✓	165.0	60.940	518.36	6061-T6
SRD200L3	✓	200.0	89.535	628.32	6061-T6
SRD203L3	✓	203.0	92.242	637.74	6061-T6
SRD250L3	✓	250.0	139.900	785.40	6061-T6
SRD280L3	✓	280.0	175.489	879.65	6061-T6

"✓" Stocked Item
 "✱" Pre-order Only Item
 (30-40 working days delivery)



Solid Square

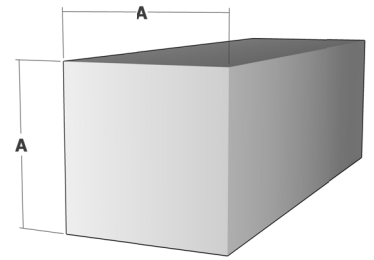

Product Code	Ex Stock	A (mm)	Mass (kg/m)	Perimeter (mm)	Grade & Temper
SQBA6.3L3	✓	6.3	0.113	25.20	6061-T6
SQBA8L3	✱	8.0	0.175	29.00	6061-T6
SQBA10L3	✓	10.0	0.284	39.10	6061-T6
SQBA12L3	✓	12.0	0.401	47.10	6061-T6
SQBA16L3	✓	16.0	0.729	63.10	6061-T6
SQBA19L3	✓	19.0	1.034	75.30	6061-T6
SQBA20L3	✓	20.0	1.139	79.10	6061-T6
SQBA25L3	✓	25.0	1.781	99.10	6061-T6
SQBA31.8L3	✓	31.8	2.881	126.30	6061-T6
SQBA33L3	✓	33.0	3.104	132.00	6061-T6
SQBA38.1L3	✓	38.1	4.136	151.40	6061-T6
SQBA40L3	✓	40.0	4.560	160.00	6061-T6
SQBA42L3	✓	42.0	5.027	168.00	6061-T6
SQBA44.5L3	✓	44.5	5.643	177.10	6061-T6
SQBA51L3	✓	51.0	7.413	201.00	6061-T6
SQBA60L3	✓	60.0	10.260	240.00	6061-T6
SQBA100L3	✓	100.0	28.500	400.00	6061-T6

"✓" Stocked Item
 "*" Pre-order Only Item
 (30-40 working days delivery)



Flat Sheet

5005 - H32

General Purpose

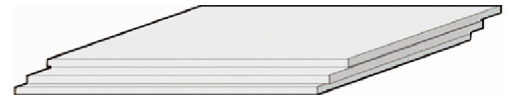

Product Code	Ex Stock	Thickness (mm)	Length (mm)	Width (mm)	Weight (kg)
5005AS071224	✓	0.70	1200	2400	5.53
5005AS0751224	✓	0.75	1200	2400	5.93
5005AS091224	✓	0.90	1200	2400	7.12
5005AS091530	✓	0.90	1500	3000	11.13
5005AS121224	✓	1.20	1200	2400	9.48
5005AS121530	✓	1.20	1500	3000	14.81
5005AS15153	✓	1.50	1500	3000	18.90
5005AS161224	✓	1.60	1200	2400	12.72
5005AS16153	✓	1.60	1500	3000	20.30
5005AS161236	✓	1.60	1200	3600	18.80
5005AS21224	✓	2.00	1200	2400	16.13
5005AS2153	✓	2.00	1500	3000	25.17
5005AS251224	✓	2.50	1200	2400	20.14
5005AS31224	✓	3.00	1200	2400	23.88
5005AS3153	✓	3.00	1500	3000	37.86
5005AS31836	✓	3.00	1800	3600	54.52
5005AS41224	✓	4.00	1200	2400	31.91
5005AS4153	✓	4.00	1500	3000	50.79
5005AS51224	✓	5.00	1200	2400	39.73
5005AS5153	✓	5.00	1500	3000	64.32
5005AS61224	✓	6.00	1200	2400	47.71

Flat Sheet

5083 - H116

Hard Marine & Transport

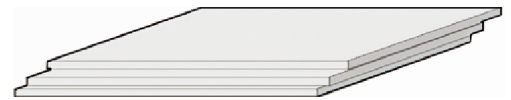

Product Code	Ex Stock	Thickness (mm)	Length (mm)	Width (mm)	Weight (kg)
5083AS31224	*	3.00	1200	2400	22.95
5083AS41224	✓	4.00	1200	2400	30.60
5083AS51224	✓	5.00	1200	2400	38.20
5083AS61224	*	6.00	1200	2400	45.90
5083AS81224	*	8.00	1200	2400	61.20
5083AS101224	*	10.00	1200	2400	76.50
5083AS121224	*	12.00	1200	2400	91.80

"✓" Stocked Item
 "✱" Pre-order Only Item
 (30-40 working days delivery)



Flat Sheet

6061 - T6

Structural

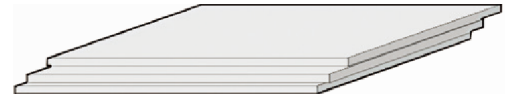

Product Code	Ex Stock	Thickness (mm)	Length (mm)	Width (mm)	Weight (kg)
6061AS412525	✓	4.00	1250	2500	34.00
6061AS512525	✓	5.00	1250	2500	42.50
6061AS612525	✓	6.00	1250	2500	54.20
6061AS812525	✓	8.00	1250	2500	71.45
6061AS8153	✓	8.00	1500	3000	107.91
6061AS1012525	✓	10.00	1250	2500	90.92
6061AS101530	✓	10.00	1500	3000	130.92
6061AS1212525	✓	12.00	1250	2500	103.00

Flat Sheet

5052 - H32

Marine Grade

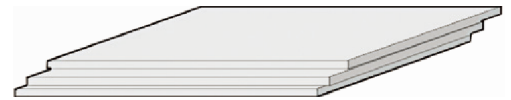

Product Code	Ex Stock	Thickness (mm)	Length (mm)	Width (mm)	Weight (kg)
5052AS071224	✓	0.70	1200	2400	5.48
5052AS161224	✓	1.60	1200	2400	12.53
5052AS16153	✓	1.60	1500	3000	19.58
5052AS21224	✓	2.00	1200	2400	16.18
5052AS2153	✓	2.00	1500	3000	25.28
5052AS251224	✓	2.50	1200	2400	20.23
5052AS31224	✓	3.00	1200	2400	24.35
5052AS3153	✓	3.00	1500	3000	38.05
5052AS41224	✓	4.00	1200	2400	31.62
5052AS51224	✓	5.00	1200	2400	39.53
5052AS61224	✓	6.00	1200	2400	47.44

"✓" Stocked Item
 "✱" Pre-order Only Item
 (30-40 working days delivery)



Standard Treadplate

5052 - H32

5 Bar Pattern



Product Code	Ex Stock	Thickness (mm)	Length (mm)	Width (mm)	Weight (kg)
5052TP15153	✓	1.50	1500	3000	18.90
5052TP161224	✓	1.60	1200	2400	13.82
5052TP21224	✓	2.00	1200	2400	17.06
5052TP251224	✓	2.50	1200	2400	21.67
5052TP31224	✓	3.00	1200	2400	25.89
5052TP3153	✓	3.00	1500	3000	40.25
5052TP41224	✓	4.00	1200	2400	33.41
5052TP4153	✓	4.00	1500	3000	52.20
5052TP51224	✓	5.00	1200	2400	41.76
5052TP5153	✓	5.00	1500	3000	65.25
5052TP61224	✓	6.00	1200	2400	50.11
5052TP6153	✓	6.00	1500	3000	77.16
5052TP81224	✓	8.00	1200	2400	66.81

Honeycomb Panel

Powdercoated both sides of surfaces

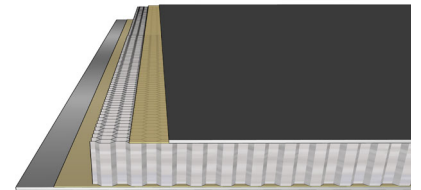

Product Code	Ex Stock	Thickness (mm)	Length (mm)	Width (mm)	Colour
HS1712525MF	✓	17.00	1250	2500	Mill Finish
HS1712525Ironsand	✓	17.00	1250	2500	Ironsand
HS1712525Black	✓	17.00	1250	2500	Black

One side powdercoated, one side mill finish

Product Code	Ex Stock	Thickness (mm)	Length (mm)	Width (mm)	Colour
HS1461022MF	✓	14.60	1000	2200	Mill Finish
HS1461022Black	✓	14.60	1000	2200	Black
HS1461022Ironsand	✓	14.60	1000	2200	Ironsand
HS14610245MF	✓	14.60	1000	2450	Mill Finish
HS14610245Black	✓	14.60	1000	2450	Black
HS14610245Ironsand	✓	14.60	1000	2450	Ironsand

"✓" Stocked Item
 "*" Pre-order Only Item
 (30-40 working days delivery)



Powder Coated Profiles Square Hollow

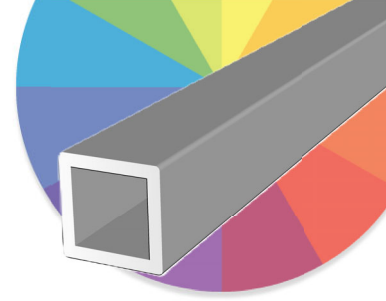

Product Code	Ex Stock	A (mm)	T (mm)	R (mm)	Length (m)	Stocked Colours
SHA19T1.2R2	✓	19.0	1.2	2.0	1.20	Matt Appliance White
SHA19T1.2R2	✓	19.0	1.2	2.0	5.97	Matt Black, Matt Appliance White
SHRA25T1.5R2	✓	25.0	1.5	2.0	5.97	Matt Black, Matt Appliance White
SHRA40T2R3	✓	40.0	2.0	3.0	5.97	Matt Black, Signal White, Dark Cedar, Antique Wood
SHRA50T2R3	✓	50.0	2.0	3.0	5.97	Matt Black, Matt Ironsand, Matt Appliance White
SHRA50T3R3	✓	50.0	3.0	3.0	5.97	Matt Black
SHRA65T2.5R3	✓	65.0	2.5	3.0	5.97	Matt Black
SHRA75T3R3	✓	75.0	3.0	3.0	5.97	Matt Black
SHA100T3	✓	100.0	3.0		3.00	Matt Black, Matt Ironsand
SHA100T3	✓	100.0	3.0		5.97	Matt Black, Matt Appliance White
SHRA100T3	✓	100.0	3.0	3.0	5.97	Matt Black, Matt Appliance White
SHRA120T3	✓	120.0	3.0	3.0	5.97	Matt Black, Matt Appliance White

Powder Coated Profiles Square Hollow with Screw Holes

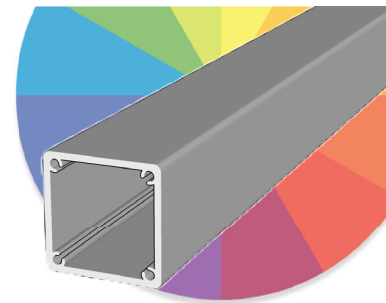

Product Code	Ex Stock	A (mm)	T (mm)	R (mm)	Length (m)	Stocked Colours
GM-NEWZ-50	✓	50.0	2.0	2.0	5.95	Matt Black, Matt Appliance White, Matt Ironsand
GM-NEWZ-49	✓	65.0	2.0	2.0	5.95	Matt Black, Matt Appliance White
GM-NEWZ-48	✓	75.0	2.5	3.0	5.95	Matt Black, Matt Ironsand, Matt Appliance White
GM-NEWZ-47	✓	100.0	4.0		5.95	Matt Black, Matt Ironsand, Matt Appliance White, Signal White

"✓" Stocked Item
 "✱" Pre-order Only Item
 (30-40 working days delivery)



Powder Coated Profiles Rectangular Hollow

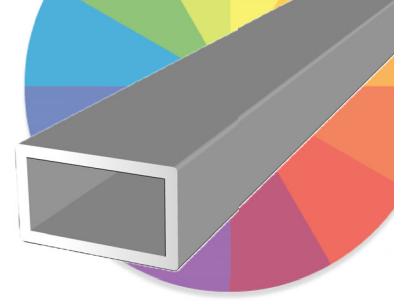

Product Code	Ex Stock	A (mm)	B (mm)	T (mm)	R (mm)	Length (m)	Stocked Colours
GM-NEWZ-127	✓	38.0	25.0	1.2		5.95	Matt Black, Matt Ironsand
GM-NEWZ-61	✓	65.0	16.0	1.2	2.0	5.95	Matt Black, Matt Appliance White
RHA75B40T2	✓	75.0	40.0	2.0		5.95	Matt Black
RHA80B50T3	✓	80.0	50.0	3.0		5.95	Matt Black, Matt Ironsand
RHRA80B50T3R3	✓	80.0	50.0	3.0	3.0	5.95	Matt Black, Matt Ironsand, Matt Appliance White
GM-NEWZ-59	✓	100.0	19.7	1.4		5.95	Matt Black, Dark Cedar, Antique White
GM-NEWZ-60	✓	100.0	19.7	1.4		5.95	Matt Black, Dark Cedar, Matt Appliance White
RHA100B44T3	✓	100.0	44.0	3.0		5.95	Dark Cedar
RHA100B50T3	✓	100.0	50.0	3.0		5.95	Matt Black, Matt Ironsand

Powder Coated Profiles Equal Angle

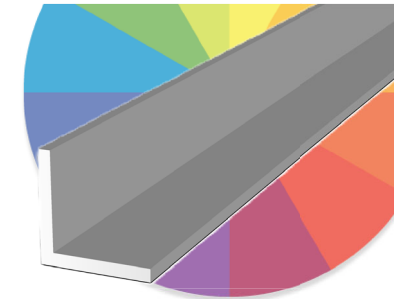

Product Code	Ex Stock	A (mm)	T (mm)	Length (m)	Stocked Colours
EAA12T1.6	✓	12.0	1.6	3.00	Matt Black, Signal White
EAA20T1.6	✓	20.0	1.6	3.00	Matt Black, Signal White
EAA25T1.6	✓	25.0	1.5	3.00	Matt Black, Signal White
EAA25T2.5	✓	25.0	2.5	5.95	Matt Black, Matt Ironsand
EAA30T1.5	✓	30.0	1.5	3.00	Matt Black, Signal White
EAA30T3	✓	30.0	3.0	5.95	Matt Black, Matt Ironsand
EAA40T1.6	✓	40.0	1.6	3.00	Matt Black, Signal White
EAA50T1.6	✓	50.0	1.6	3.00	Matt Black
EAA50T3	✓	50.0	3.0	5.95	Matt Black, Matt Ironsand
EAA50T6	✓	50.0	6.0	5.95	Matt Black, Matt Ironsand

"✓" Stocked Item
 "✱" Pre-order Only Item
 (30-40 working days delivery)



Powder Coated Profiles Round Tube



Product Code	Ex Stock	D (mm)	T (mm)	Length (m)	Stocked Colours
RTD19T1.2	✓	19.0	1.2	5.95	Matt Black, Matt Appliance White
RTD19T1.6	✓	19.0	1.6	5.95	Matt Black, Matt Appliance White
RTD40T0.9	✓	40.0	0.9	5.95	Matt Black, Matt Ironsand, Signal White, Matt Charcoal

Powder Coated Profiles Flat Bar

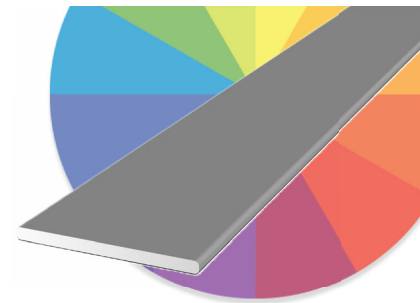

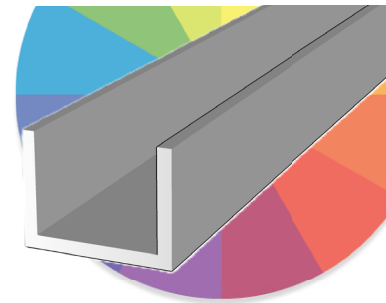

Product Code	Ex Stock	A (mm)	T (mm)	Length (m)	Stocked Colours
FBA25T3	✓	25.0	3.0	5.97	Matt Black, Signal White
FBA50T3	✓	50.0	3.0	5.97	Matt Black
FBA50T10	✓	50.0	10.0	5.97	Matt Black, Matt Ironsand
FBA70T10	✓	70.0	10.0	6.00	Matt Black
FBA90T6	✓	90.0	6.0	5.40	Matt Black, Matt Appliance, Matt Ironsand, Dark Cedar

Powder Coated Profiles Channel

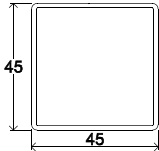
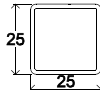
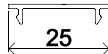
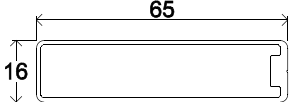
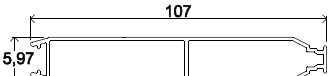
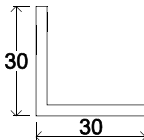
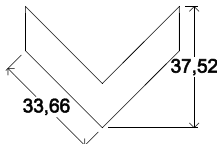
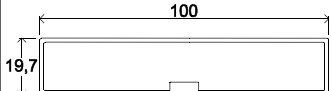
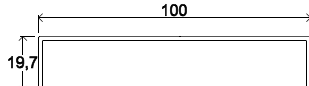
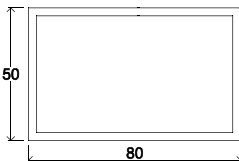
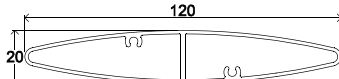
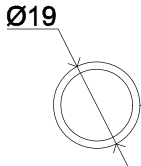
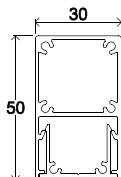
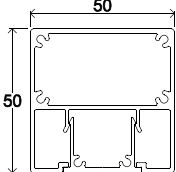
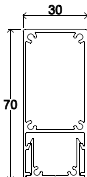
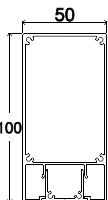

Product Code	Ex Stock	A (mm)	B (mm)	T (mm)	Length (m)	Stocked Colours
CLA50B15T3	✓	50.0	15.0	3.0	5.97	Matt Black, Matt Ironsand
CLA50B50T3	✓	50.0	50.0	3.0	5.95	Matt Black, Matt Ironsand
CLA58B65T3.5	✓	58.0	65.0	3.5	5.95	Matt Black, Matt Ironsand

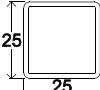
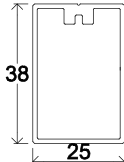
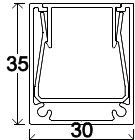
							
Product Code	SHS45T1.6Punch	Product Code	SHARA25T1.5R2L2	Product Code	GM-NEWZ-139	Product Code	GM-NEWZ-61
Weight (Kg/m)	0.783	Weight (Kg/m)	0.393	Weight (Kg/m)	0.103	Weight (Kg/m)	0.617
							
Product Code	GM-NEWZ-05	Product Code	30x30x3JL	Product Code	SL-77	Product Code	GM-NEWZ-60
Weight (Kg/m)	0.896	Weight (Kg/m)	0.487	Weight (Kg/m)		Weight (Kg/m)	1.021
							
Product Code	GM-NEWZ-59	Product Code	WZ-80x50x3RPunch	Product Code	GM-NEWZ-06	Product Code	D19x1.6
Weight (Kg/m)	0.932	Weight (Kg/m)	2.120	Weight (Kg/m)	1.087	Weight (Kg/m)	0.103
							
Product Code	GM-NEWZ-51&53	Product Code	GM-NEWZ-54&53	Product Code	GM-NEWZ-52&53	Product Code	GM-NEWZ-55&53
Weight (Kg/m)	1.037	Weight (Kg/m)	1.447	Weight (Kg/m)	0.984	Weight (Kg/m)	1.872
							
Product Code	19x19x1.2R	Product Code	25x25x1.5R	Product Code	GM-NEWZ-127	Product Code	GM-NEWZ-56-57-58
Weight (Kg/m)	0.235	Weight (Kg/m)	0.393	Weight (Kg/m)	0.497	Weight (Kg/m)	0.808

Fence System Profiles

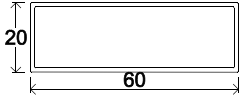
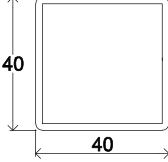
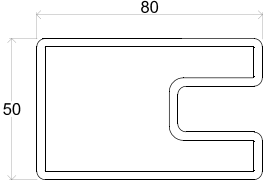
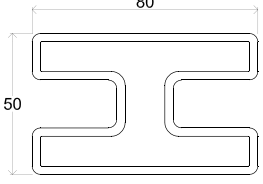





							
Product Code	DLX-10	Product Code	GM-NEWZ-40x40x2	Product Code	GM-NEWZ-153	Product Code	GM-NEWZ-186
Weight (Kg/m)	0.531	Weight (Kg/m)	0.857	Weight (Kg/m)	2.530	Weight (Kg/m)	3.060



							
Product Code	SL-30	Product Code	SL-31	Product Code	SL-74	Product Code	SL-138
Description	Fence Bracket for 38x25 Rail	Description	Fence Bracket for 40x40 Rail	Description	Fence Bracket for 45x45 Rail	Description	Fence Bracket for 50x50 Rail
							
SL-150 For 38x25 Rail		SL-197 For 25x38 Rail				For 50x50mm Post Stocked in Matt Black, Matt Appliance White	
Product Code		Product Code	SL-151	Product Code	SL-154	Product Code	SL-89
Description	Fence Bracket for 38x25 Rail	Description	Fence Bracket for 40x40 Rail	Description	Fence Bracket for 50x25 Rail	Description	Post Flange Plate
							
For 65x65mm Post Stocked in Matt Black, Matt Appliance White		For 75x75mm Post Stocked in Matt Black, Matt Appliance White		For 100x100mm Post Stocked in Matt Black, Matt Appliance White		For 50x50mm Post Stocked in Matt Black, Silver	
Product Code	SL-90	Product Code	SL-91	Product Code	SL-92	Product Code	SL-25
Description	Post Flange Plate	Description	Post Flange Plate	Description	Post Flange Plate	Description	50mm Aluminium Post Cap
							
For 50x50mm Post Stocked in Matt Black, Matt Appliance White, Silver		For 65x65mm Post Stocked in Matt Black, Matt Appliance White, Silver		For 75x75mm Post Stocked in Matt Black, Matt Appliance White, Silver		For 100x100mm Post Stocked in Matt Black, Matt Appliance White, Silver	
Product Code	SL-41	Product Code	SL-40	Product Code	SL-39	Product Code	SL-38
Description	Square Metal Post Cap	Description	Square Metal Post Cap	Description	Square Metal Post Cap	Description	Square Metal Post Cap
							
For D50mm Post Stocked in Silver		For D65mm Post Stocked in Silver		For D75mm Post Stocked in Silver		For D100mm Post Stocked in Silver	
Product Code	SL-37	Product Code	SL-36	Product Code	SL-35	Product Code	SL-34
Description	Round Metal Post Cap	Description	Round Metal Post Cap	Description	Round Metal Post Cap	Description	Round Metal Post Cap

							
<i>For D16x1.6 Round Tube</i>		<i>For D19x1.6 Round Tube</i>		<i>For D40x2.0 Round Tube</i>		<i>For D50x2.0 Round Tube</i>	
Product Code	SL-99	Product Code	SL-89	Product Code	SL-59	Product Code	SL-60
Description	Round Plastic Picket Cap	Description	Round Plastic Picket Cap	Description	Round Plastic Picket Cap	Description	Round Plastic Picket Cap
							
<i>For D60x2.0 Round Tube</i>		<i>For 19x19mm Square Tube</i>		<i>For 25x25mm Square Tube</i>		<i>For 40x40mm Square Tube</i>	
Product Code	SL-61	Product Code	SL-104	Product Code	SL-173	Product Code	SL-176
Description	Round Plastic Picket Cap	Description	Square Plastic Picket Cap	Description	Square Plastic Picket Cap	Description	Square Plastic Picket Cap
							
<i>For 40x40mm Square Tube</i>		<i>For 50x50mm Square Tube</i>		<i>For 63.5x63.5mm Square Tube</i>		<i>For 65x65mm Square Tube</i>	
Product Code	SL-151	Product Code	SL-54	Product Code	SL-55	Product Code	SL-253
Description	Square Plastic Picket Cap	Description	Square Plastic Picket Cap	Description	Square Plastic Picket Cap	Description	Square Plastic Picket Cap
							
<i>For 75x75mm Square Tube</i>		<i>For NEWZ-127 Picket Or 38x25mm Rectangular Picket</i>		<i>For 38x25mm Rectangular Tube</i>		<i>For 50x25mm Square Tube</i>	
Product Code	SL-56	Product Code	SL-161	Product Code	SL-150	Product Code	SL-175
Description	Square Plastic Picket Cap	Description	Rectangular Plastic Picket Cap	Description	Rectangular Plastic Picket Cap	Description	Rectangular Plastic Picket Cap
							
<i>For 80x50mm Rectangular Tube</i>		<i>For 100x50mm Rectangular Tube</i>		<i>For 65x16mm Rectangular Tube</i>		<i>For 100x19.7mm Rectangular Tube</i>	
Product Code	SL-57	Product Code	SL-58	Product Code	SL-22	Product Code	SL-12
Description	Rectangular Plastic Picket Cap	Description	Rectangular Plastic Picket Cap	Description	Rectangular Plastic Picket Cap	Description	Rectangular Plastic Picket Cap

Fence System Accessories

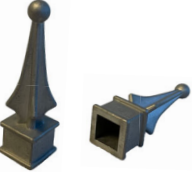
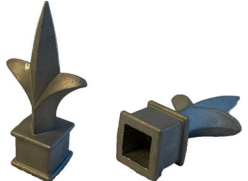
						 Spear Head for D19 Round Tube	
Product Code	SL-170	Product Code	SL-171	Product Code	SL-169	Product Code	SL-64
Weight (Kg/m)	Hydraulic Hinge	Weight (Kg/m)	Standard Hinge	Weight (Kg/m)	Pedestrian Gate Latch	Weight (Kg/m)	Round Spear Head
						 Spear Head for 16x16 SHS	
Product Code	SL-63	Product Code	SL-65	Product Code	SL-67	Product Code	SL-66
Weight (Kg/m)	Round Spear Head	Weight (Kg/m)	Square Spear Head	Weight (Kg/m)	Square Spear Head	Weight (Kg/m)	Square Spear Head

Fence Hardwares

									
Product Code	SHG-90 / SHG-90L	Product Code	SHF-90L / SHF-90L-1	Product Code	SHN-90L / SHN-90L-1	Product Code	SHH-135LS / SHH-135S	Product Code	SHC-135
Weight (Kg/m)	Adjustable Tension Hinge	Weight (Kg/m)	Fixed Tension Hinge	Weight (Kg/m)	Neutral Tension Hinge	Weight (Kg/m)	Heavy Duty Tension Hinge	Weight (Kg/m)	Self-adjustable Coilkilk Hinge
									
Product Code	SLV-VIPER X1 / X1-IK	Product Code	SLV-VIPER X2 / X2-IK	Product Code	SL-25H	Product Code	SL-50H	Product Code	SL-50K
Weight (Kg/m)	Single Side Gravity Latch	Weight (Kg/m)	Double Side Gravity Latch	Weight (Kg/m)	Top Pull Magnetic Gate Latch	Weight (Kg/m)	Top Pull Magnetic Gate Latch	Weight (Kg/m)	Top Pull Magnetic Latch
 Top Pull Lockable Trilatch - Child Safety Design Magnetic Gate Latch									
Product Code	SL-50TRI	Product Code	SHN-90L / SHN-90L-1	Product Code	SGSS	Product Code	SGSL		
Weight (Kg/m)	Top Pull Magnetic Latch	Weight (Kg/m)	Neutral Tension Hinge	Weight (Kg/m)	Small Size Gate Stop	Weight (Kg/m)	Large Size Gate Stop		

Pre-Punched Extrusions

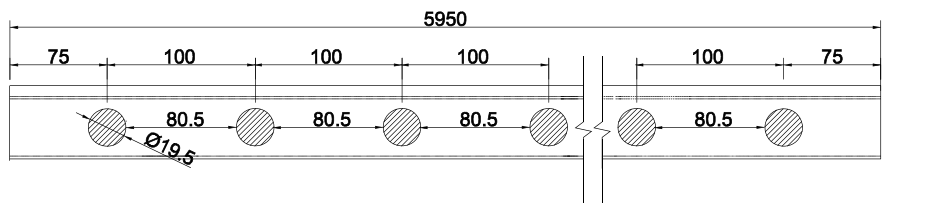
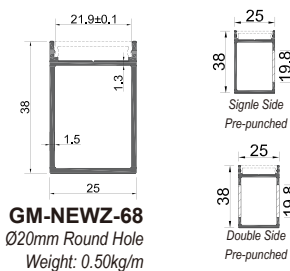
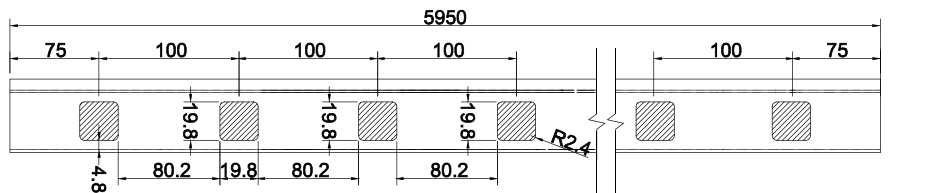
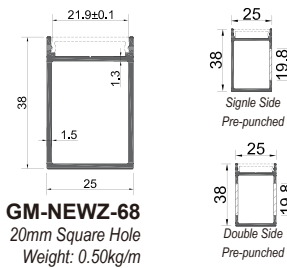
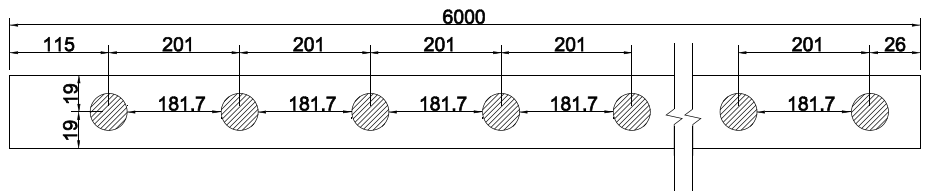
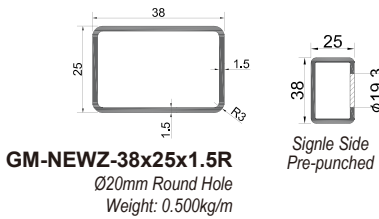
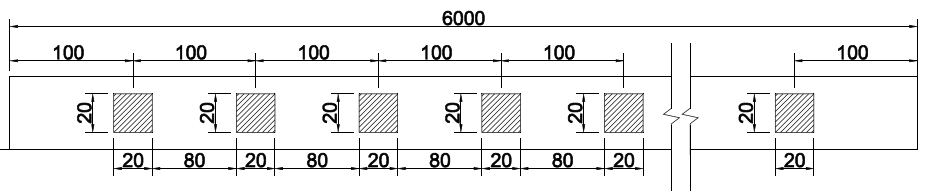
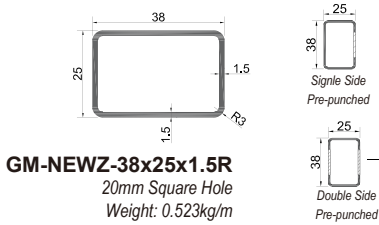
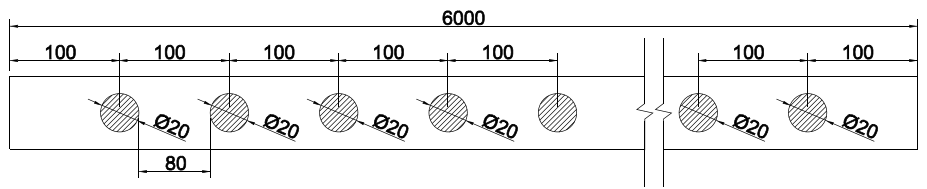
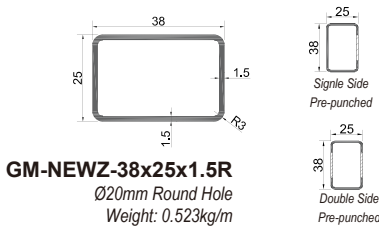
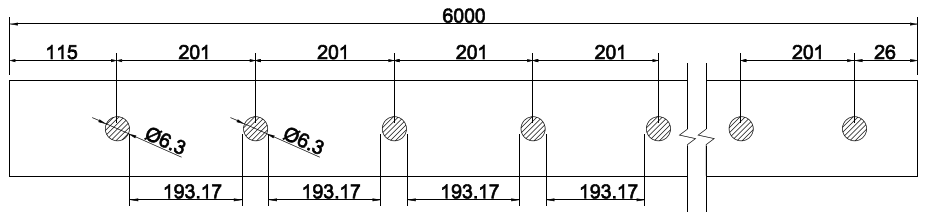
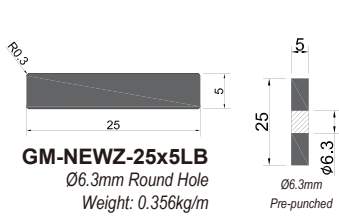
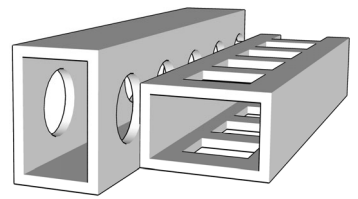

Pre-Punched Extrusions

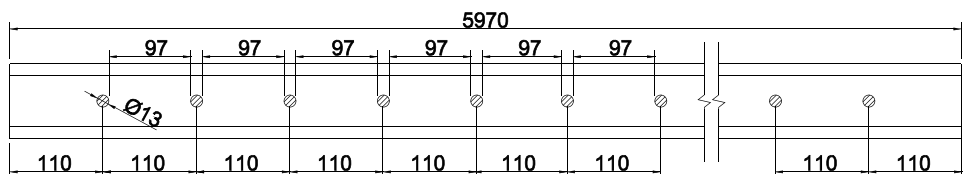
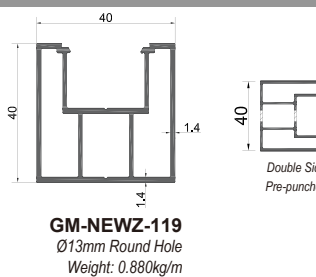
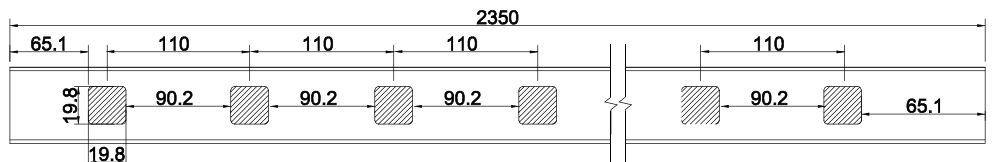
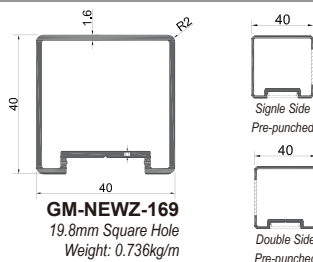
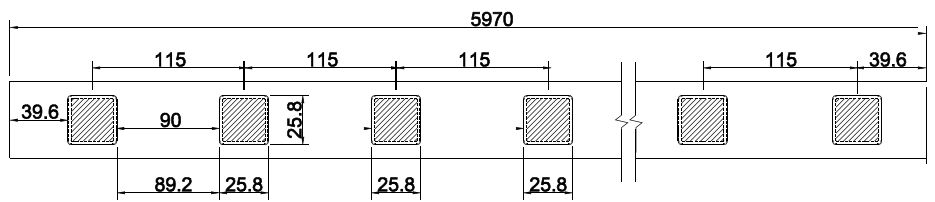
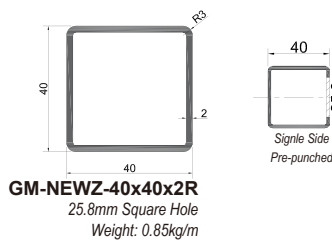
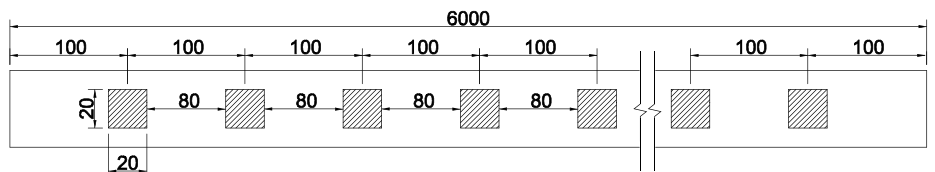
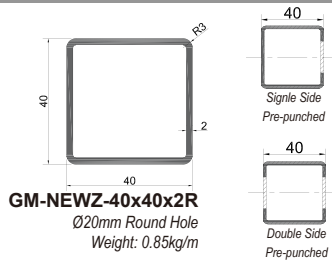
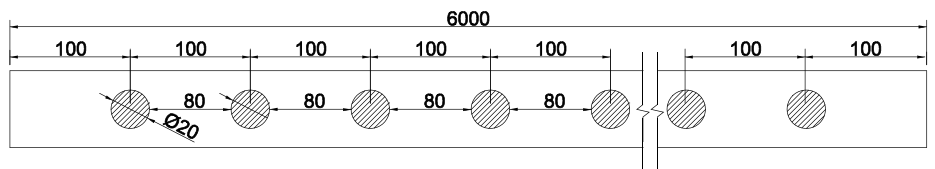
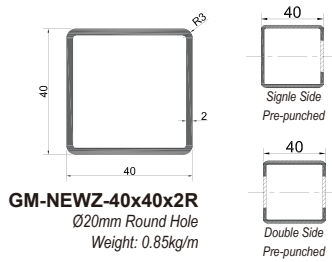
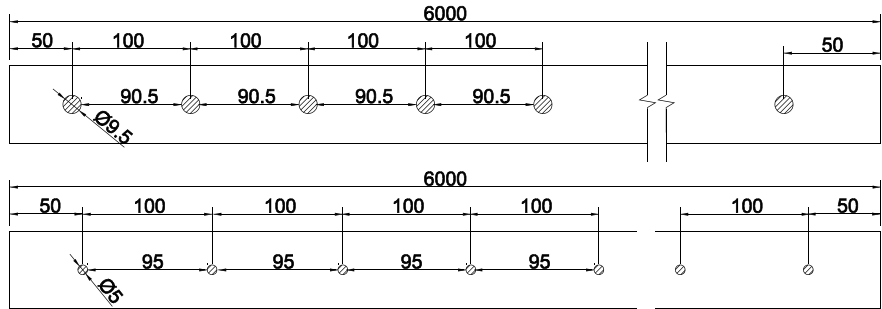
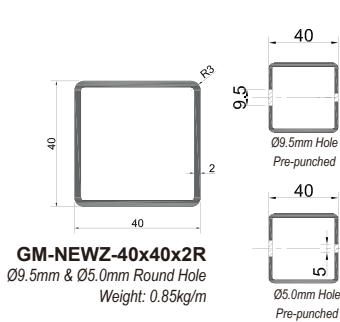
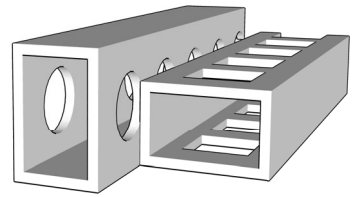

Pre-Punched Extrusions

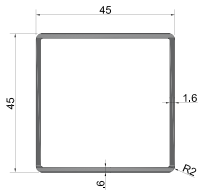
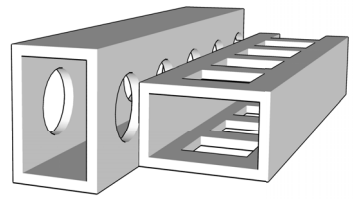

GM-NEWZ-45x45x1.6R
25.6mm Square Hole
Weight: 0.783kg/m

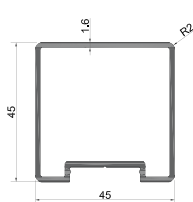
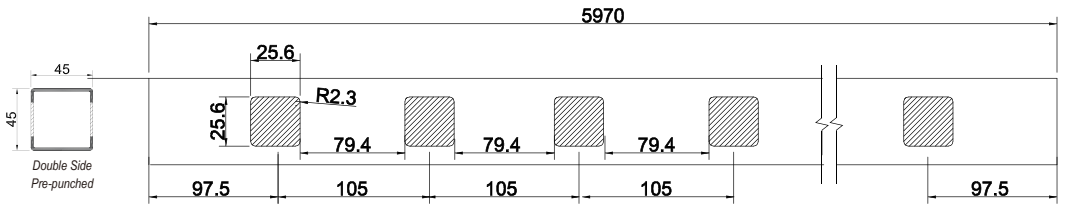

GM-NEWZ-167
25.8mm Square Hole
Weight: 0.830kg/m

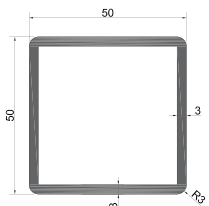
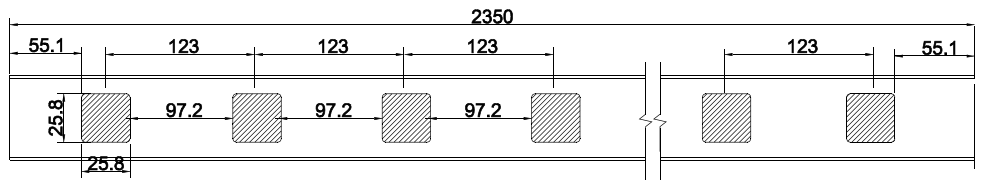
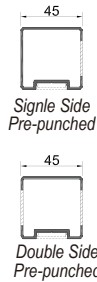

GM-NEWZ-50x50x3R
Ø20mm Round Hole
Weight: 1.67kg/m

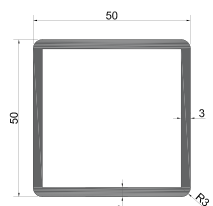
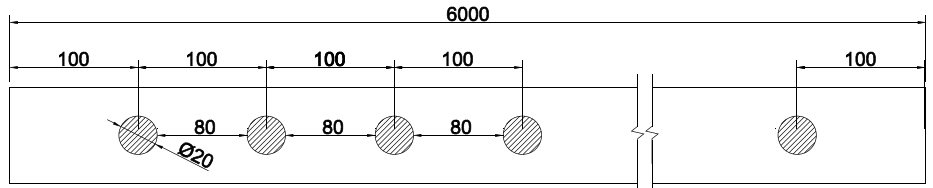
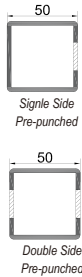

GM-NEWZ-50x50x3R
20mm Square Hole
Weight: 1.585kg/m

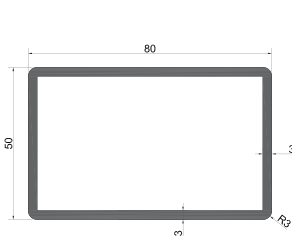
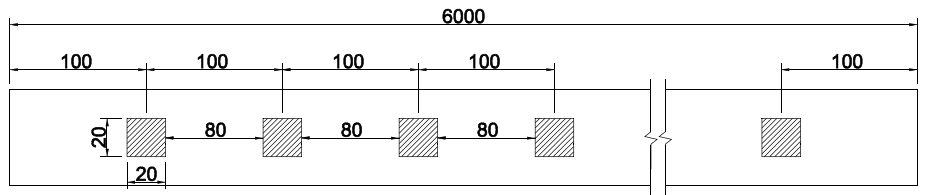
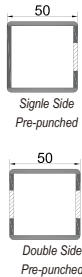

WZ-80x50x3R
Ø20mm Round Hole
Weight: 2.21kg/m

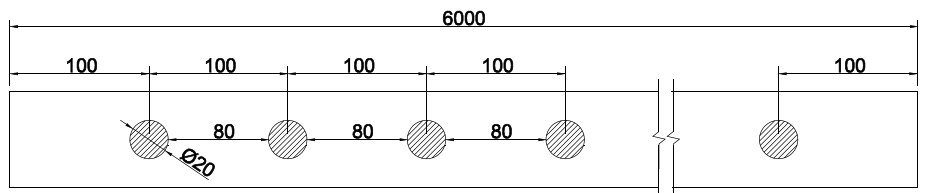
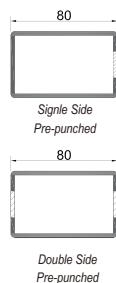

Pre-Punched Extrusions

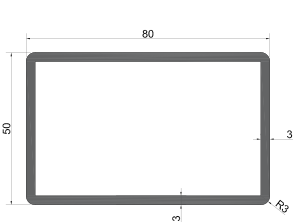
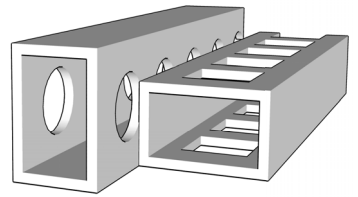

WZ-80x50x3R
20mm Square Hole
Weight: 2.21kg/m

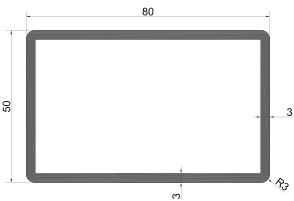
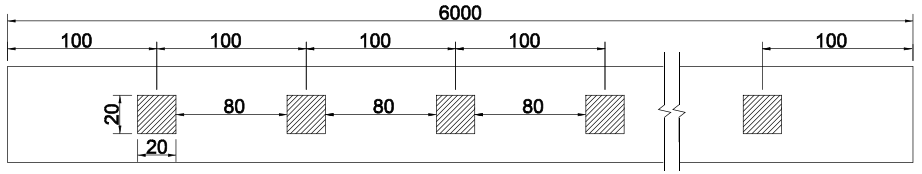
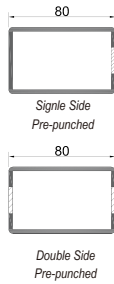

WZ-80x50x3R
25.8mm Square Hole
Weight: 2.100kg/m

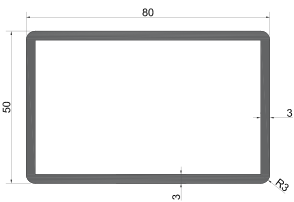
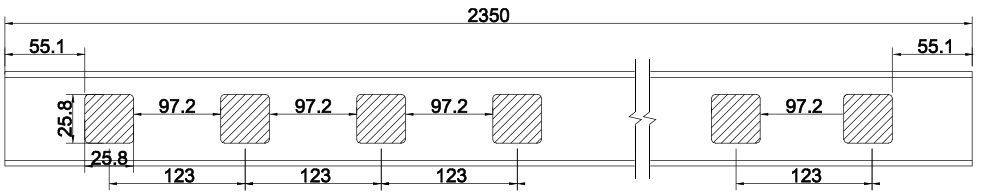
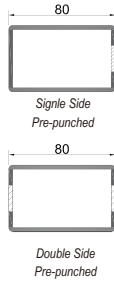

WZ-80x50x3R
25.8mm Square Hole
Weight: 2.100kg/m

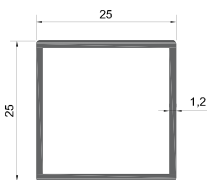
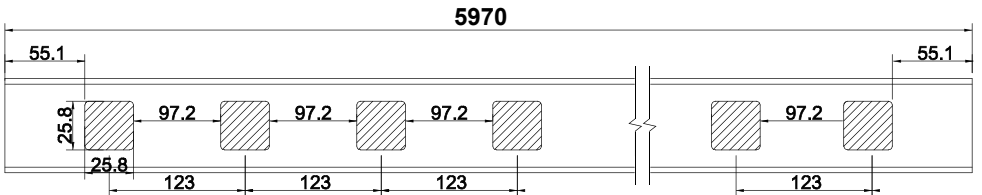
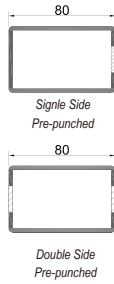

SHARA25T1.2R
25x25x1.2R2L2.1mm Square Hollow

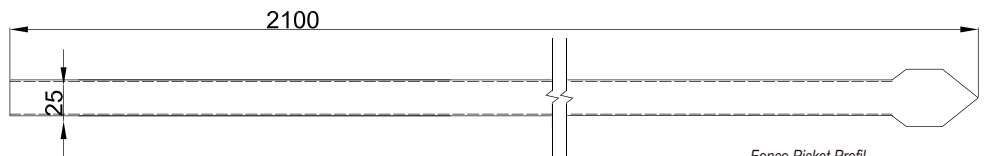

Fence Picket Profil
Fit WZ-80x50x3R Punched

Pre-Punched Extrusions

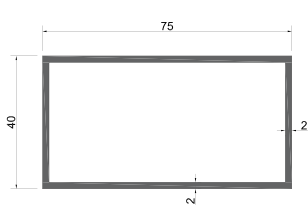
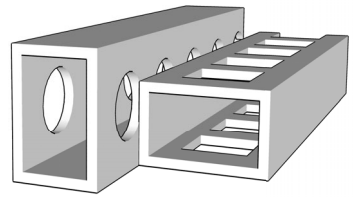

GM-NEWZ-75x40x2
GM-NEWZ-06 Hole
Weight: 1.265kg/m

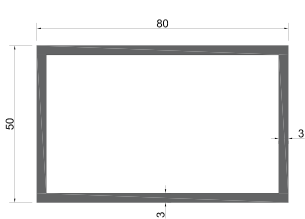
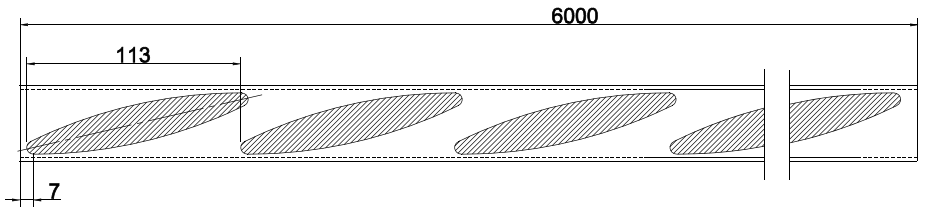
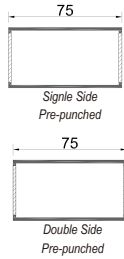

GM-NEWZ-80x50x3
GM-NEWZ-06 Hole
Weight: 2.33kg/m

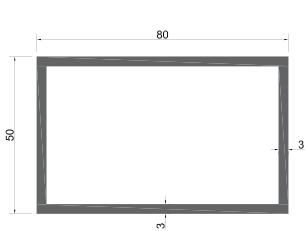
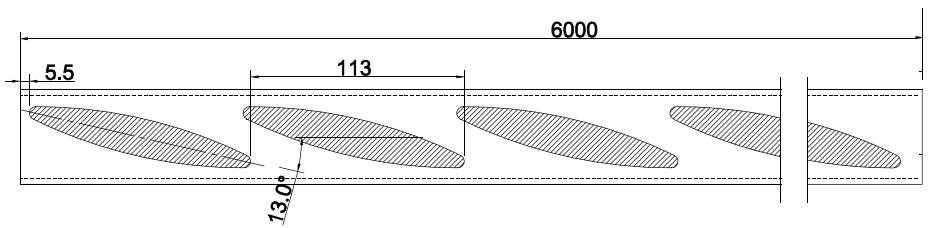
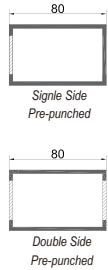

GM-NEWZ-80x50x3
GM-NEWZ-06 Hole
Weight: 2.12kg/m

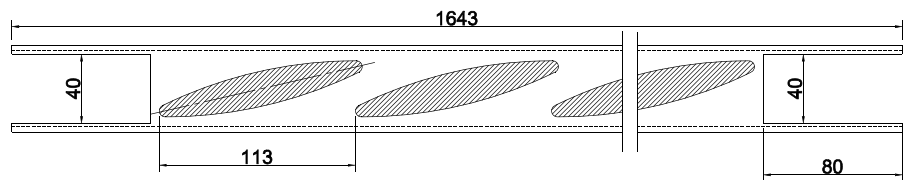
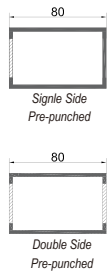

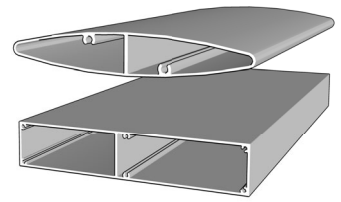

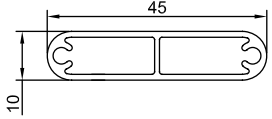
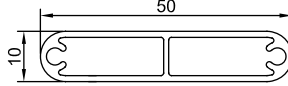
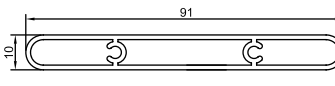
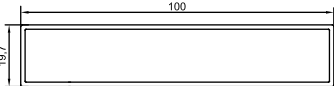
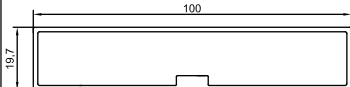
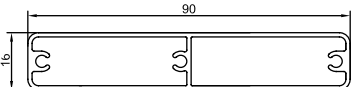
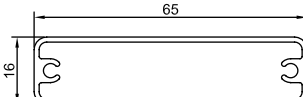
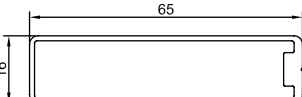
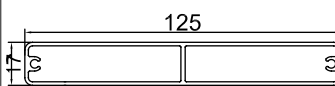
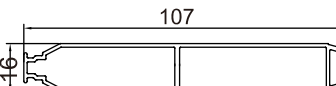
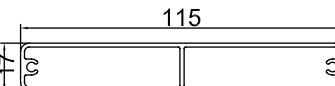
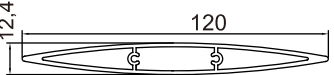
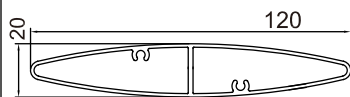
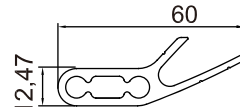
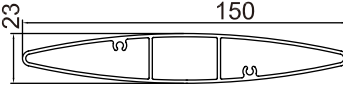
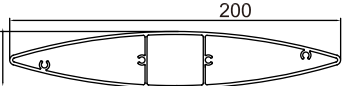
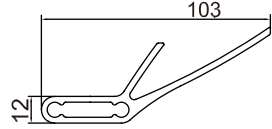
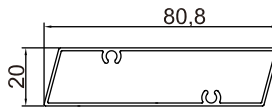
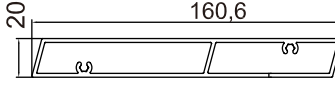
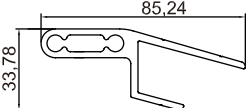
							
Product Code	GM-NEWZ-95	Product Code	GM-NEWZ-96	Product Code	GM-NEWZ-07	Product Code	GM-NEWZ-59
Weight (Kg/m)	0.410	Weight (Kg/m)	0.420	Weight (Kg/m)	0.880	Weight (Kg/m)	0.880
							
Product Code	GM-NEWZ-60	Product Code	GM-NEWZ-09	Product Code	GM-NEWZ-04	Product Code	GM-NEWZ-61
Weight (Kg/m)	0.930	Weight (Kg/m)	0.860	Weight (Kg/m)	0.650	Weight (Kg/m)	0.690
							
Product Code	GM-NEWZ-94	Product Code	GM-NEWZ-05	Product Code	GM-NEWZ-93	Product Code	GM-NEWZ-65
Weight (Kg/m)	1.250	Weight (Kg/m)	1.100	Weight (Kg/m)	1.160	Weight (Kg/m)	1.170
							
Product Code	GM-NEWZ-06	Product Code	GM-NEWZ-71	Product Code	GM-NEWZ-70	Product Code	GM-NEWZ-102
Weight (Kg/m)	1.090	Weight (Kg/m)	1.080	Weight (Kg/m)	1.340	Weight (Kg/m)	1.053
							
Product Code	GM-NEWZ-130	Product Code	GM-NEWZ-142	Product Code	GM-NEWZ-143	Product Code	GM-NEWZ-144
Weight (Kg/m)	0.510	Weight (Kg/m)	0.610	Weight (Kg/m)	2.210	Weight (Kg/m)	1.450

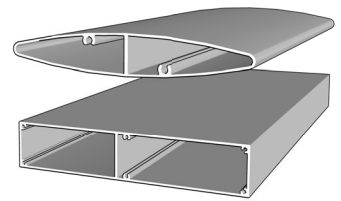



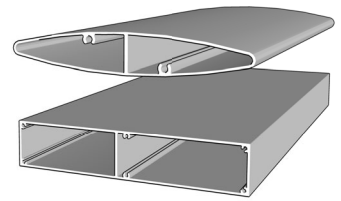

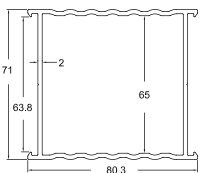
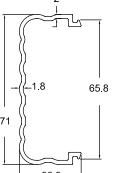
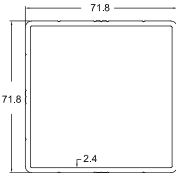
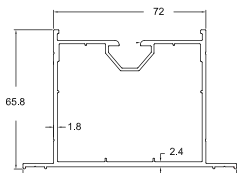
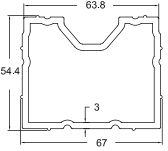
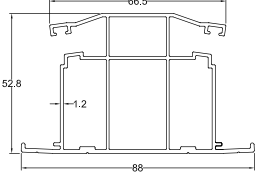
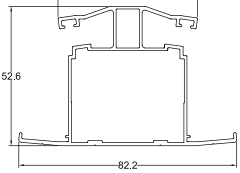
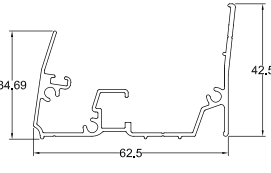
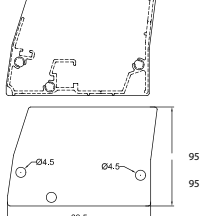
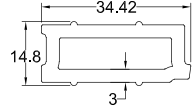
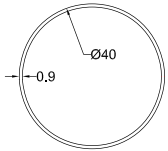
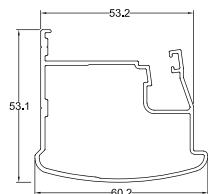
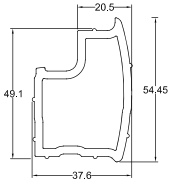
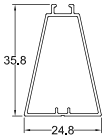
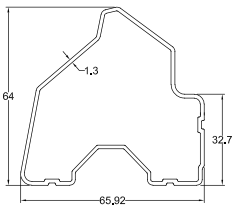
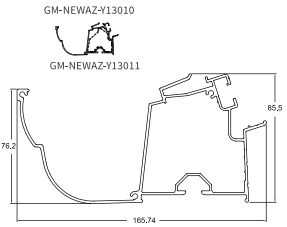
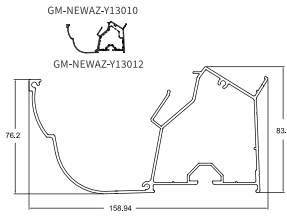
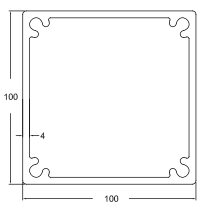
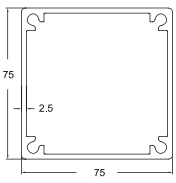
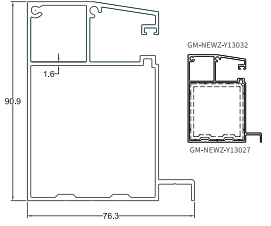

Product Code	CLSA50B50T3	Product Code	GM-NEWZ-56 & 57 & 58	Product Code	GM-NEWZ-51 & 53	Product Code	GM-NEWZ-52 & 53
Weight (Kg/m)	1.219	Weight (Kg/m)	0.770	Weight (Kg/m)	1.070	Weight (Kg/m)	1.220
Product Code	GM-NEWZ-54 & 53	Product Code	GM-NEWZ-55 & 53	Product Code	GM-NEWZ-97	Product Code	NEWZ120
Weight (Kg/m)	1.480	Weight (Kg/m)	1.910	Weight (Kg/m)	1.680	Weight (Kg/m)	1.910
Product Code	GM-NEWZ-98	Product Code	GM-NEWZ-101	Product Code	GM-NEWZ-100	Product Code	GM-NEWZ-131
Weight (Kg/m)	2.480	Weight (Kg/m)	3.460	Weight (Kg/m)	4.840	Weight (Kg/m)	5.750
Product Code	RHA200B75T3	Product Code	GM-NEWZ-181	Product Code	GM-NEWZ-182	Product Code	GM-NEWZ-183
Weight (Kg/m)	4.600	Weight (Kg/m)	1.210	Weight (Kg/m)	1.770	Weight (Kg/m)	0.05
Product Code	GM-NEWZ-181 End Cap	Product Code	GM-NEWZ-182 End Cap	Product Code	GM-NEWZ-184	Product Code	SHA50T2.0
Weight (Kg/m)	0.011	Weight (Kg/m)	0.018	Weight (Kg/m)	4.690	Weight (Kg/m)	1.094

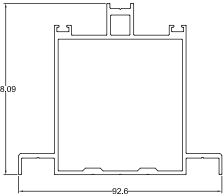
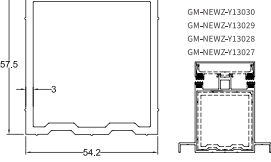
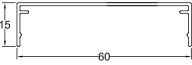
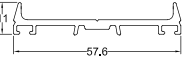
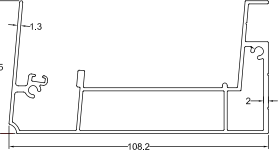
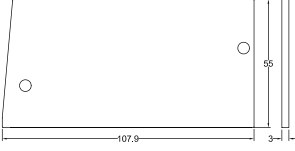

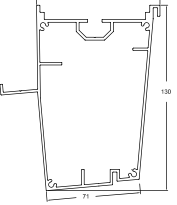
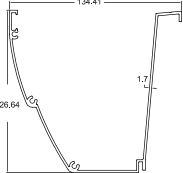
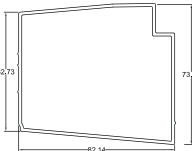
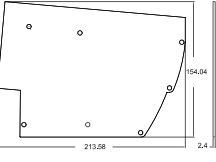
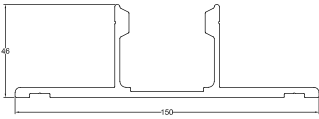
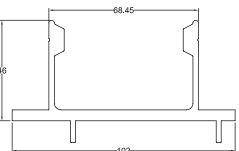
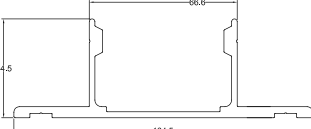
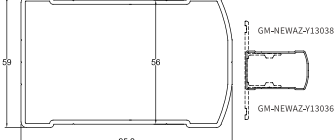
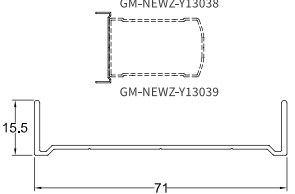

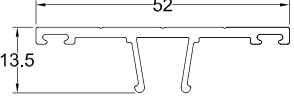
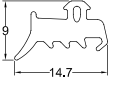

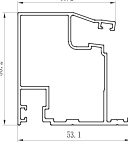
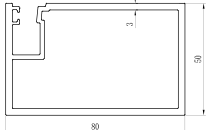
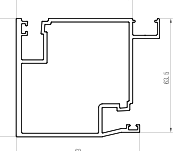
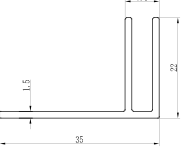
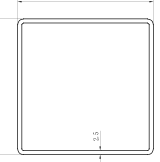
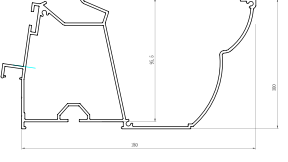
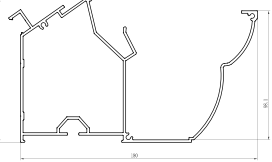
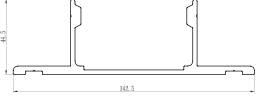
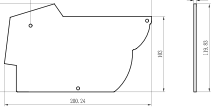
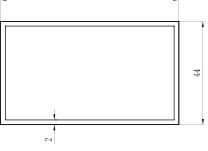
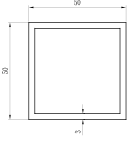
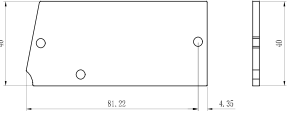
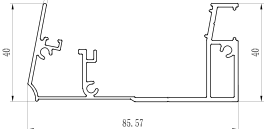
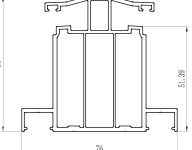
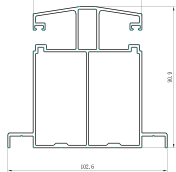
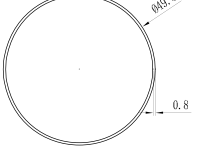





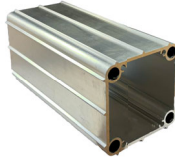

						<p>For 40x40x2 SHS 50x40x3 RHS 60x40x3 RHS 75x40x3 RHS 80x40x3 RHS</p>	
Product Code	RHA125B30T2.5	Product Code	RHA150B30T2.5	Product Code	RHA80B50T3	Product Code	GM-KPM-122
Weight (Kg/m)	2.138	Weight (Kg/m)	2.494	Weight (Kg/m)	2.120	Weight (Kg/m)	2.640
<p>For 300x50x2.0 RHS 250x50x2.0 RHS 200x50x2.0 RHS 150x50x2.0 RHS 100x50x2.0 RHS 80x50x2.0 RHS</p>		<p>For 300x50x2.5 RHS 250x50x2.5 RHS 200x50x2.5 RHS 150x50x2.5 RHS 100x50x2.5 RHS 80x50x2.5 RHS</p>		<p>For 80x50x3 RHS</p>		<p>For 38x25x2 RHS 25x25x2.5 RHS 40x25x2.5 RHS 50x25x2.5 RHS 60x25x2.5 RHS 100x25x2.5 RHS 120x25x2.5 RHS 150x25x2.5 RHS 200x25x2.5 RHS 250x25x2.5 RHS 300x25x2.5 RHS</p>	
Product Code	GM-NEWZ-133	Product Code	GM-NEWZ-134	Product Code	GM-NEWZ-123	Product Code	GM-NEWZ-121
Weight (Kg/m)	2.673	Weight (Kg/m)	2.686	Weight (Kg/m)	5.570	Weight (Kg/m)	1.730
		<p>For 50x50x3 SHS 65x40x2 RHS 60x40x2 RHS 75x40x2 RHS 80x40x2 RHS</p>		<p>For GM-NEWZ-98 GM-NEWZ-97 GM-NEWZ-120 GM-NEWZ-101 GM-NEWZ-100</p>			
Product Code	GM-NEWZ-145	Product Code	GM-KPM-5511	Product Code	SL-149	Product Code	GM-NEWZ-58x65x3.5U
Weight (Kg/m)	4.480	Weight (Kg/m)	5.970	Weight (Kg/m)	3.000	Weight (Kg/m)	1.870
Product Code	Louvre Roller	Product Code	SL-157	Product Code	SL-155	Product Code	SL-156
Weight (Kg/m)		Weight (Kg/m)	2.290	Weight (Kg/m)	6.130	Weight (Kg/m)	3.240
Product Code	GM-NEWZ-135						
Weight (Kg/m)	0.720						

							
Product Code	GM-NEWZ-Y13001	Product Code	GM-NEWZ-Y13002	Product Code	GM-NEWZ-Y13026	Product Code	GM-NEWZ-Y13003
Description	Pillar	Description	Pillar Cap	Description	Pillar - New Style	Description	Top Beam
							
Product Code	GM-NEWZ-Y13023	Product Code	GM-NEWZ-Y13005	Product Code	GM-NEWZ-Y13006	Product Code	GM-NEWZ-Y13007
Description	Flat Top Extended Ferrule	Description	Premium Frame	Description	Standard Frame	Description	Wall Edge
							
Product Code	GM-NEWZ-95x3.5	Product Code	GM-NEWZ-Y13022	Product Code	GM-NEWZ-D40x0.9	Product Code	GM-NEWZ-Y13008
Description	Wall Edge End Cap	Description	Strengthen Frame Extended Ferrule	Description	Water Pipe	Description	Side Frame
							
Product Code	GM-NEWZ-Y13024	Product Code	GM-NEWZ-Y13009	Product Code	GM-NEWZ-Y13010	Product Code	GM-NEWZ-Y13011
Description	Side Frame Extended Ferrule	Description	Support Bar	Description	Gutter Extended Ferrule	Description	Straight Edge Gutter
							
Product Code	GM-NEWZ-Y13012	Product Code	GM-NEWZ-47	Product Code	GM-NEWZ-48	Product Code	GM-NEWZ-Y13032
Description	Radius Edge Gutter	Description	100mm Strengthen Pillar	Description	75mm Strengthen Pillar	Description	Strengthen Side Girder

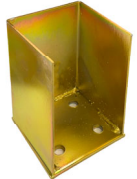
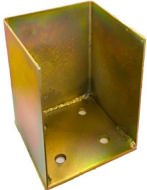
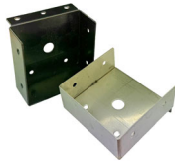
							
Product Code	GM-NEWZ-Y13028	Product Code	GM-NEWZ-Y13027	Product Code	GM-NEWZ-Y13030	Product Code	GM-NEWZ-Y13029
Description	Strengthen Girder	Description	Girder Ferrule	Description	Strengthen Girder Cap	Description	Strengthen Girder Seat
							
Product Code	GM-NEWZ-Y13031	Product Code	SL-85	Product Code	GM-NEWZ-Y13033	Product Code	GM-NEWZ-Y13034
Description	Reinforce Fixed Wall Eaves	Description	Wall Eaves End Cap	Description	Strengthen Support Bar	Description	Strengthen Sink Front
							
Product Code	GM-NEWZ-Y13035	Product Code	GM-NEWZ-Y13037	Product Code	GM-JL-70	Product Code	GM-NEWZ-Y13036
Description	Strengthen Gutter	Description	Front Gutter Ferrule	Description	Gutter End Cap	Description	Bottom Jointer
							
Product Code	GM-NEWZ-Y13040	Product Code	GM-NEWZ-Y13004	Product Code	GM-NEWZ-Y13038	Product Code	GM-NEWZ-Y13039
Description	100mm Post Jointer	Description	Bottom Jointer	Description	Window Shed Main Beam	Description	Drop Cover
							
Product Code	GM-NEWZ-117	Product Code	GM-NEWZ-191	Product Code	GM-NEWZ-118	Product Code	NZJT-022
Description	4.2mm Middle PC Board Base	Description	4.2mm Side PC Board Base	Description	4.2mm PC Board Clip	Description	4.2mm PC Board Rubber

							
Product Code	GM-NEWZ-Y13065	Product Code	GM-NEWZ-Y13056	Product Code	GM-NEWZ-Y13062	Product Code	GM-NEWZ-Y13057
Description	New A3 Edge Frame	Description	A5 Side Post	Description	A5 Side Frame	Description	Board Holder
							
Product Code	GM-80x80x2.5R	Product Code	GM-NEWZ-Y13063	Product Code	GM-NEWZ-Y13064	Product Code	GM-NEWZ-Y13058
Description	A5 80mm Post	Description	A5 Straight Edge Gutter	Description	A5 Round Edge Gutter	Description	A5 Post Flange Plate
							
Product Code	GM-NEWZ-Y13063-64 End Cap	Product Code	GM-76x44x2.0	Product Code	GM-NEWZ-50x50x3	Product Code	GM-NEWZ-Y13059 End Cap
Description	Straight / Round Gutter End Cap	Description		Description		Description	A5 Wall Edge End Cap
							
Product Code	GM-NEWZ-Y13059	Product Code	GM-NEWZ-Y13060	Product Code	GM-NEWZ-Y13066	Product Code	GM-D49.5x0.8
Description	A5 Wall Edge	Description	Strengthen Frame	Description	One-Piece Main Frame	Description	50mm Drain Pipe
							
Product Code	GM-NEWZ-Y13061						
Description	Double-slot Support Bar						

							
Product Code	SL-148	Product Code	SL-149	Product Code	SL-188	Product Code	SL-189
Description	Wall Connector Cover	Description	Wall Connector	Description	Wall Screw	Description	Wall Screw Cover
							
Product Code	SL-190	Product Code	SL-187	Product Code	SL-114	Product Code	SL-116
Description	Wall Screw Cap	Description	M8 Expansion Bolt	Description	40mm Bend Pipe Connector	Description	40mm Drain Pipe Clamp
							
Product Code	SL-115	Product Code	SL-255	Product Code	SL-256	Product Code	SL-254
Description	Plastic 40mm Pipe Connector	Description	Aluminium 50mm Connector	Description	50mm Drain Pipe Clamp	Description	50mm Bend Pipe Connector
							
Product Code	SL-138	Product Code	SL-145	Product Code	PC Endurance Board		SL-120
Description	Aluminium Corner Bracket	Description	Top Beam Cap	Description	2.0mm / 3.0mm		Galvanized Flat Jointer
							
Product Code	SL-134	Product Code	SL-122	Product Code	M8x16	Product Code	M4x16
Description	90° 600x500mm Connector	Description	90° Angle Connector	Description	Plain Stainless Steel Hex Bolt	Description	Stainless Steel Pan Self Drill

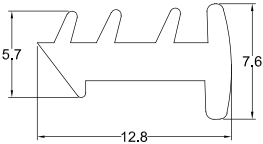
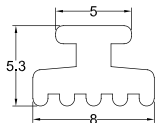
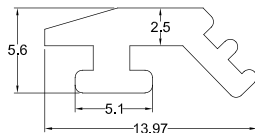
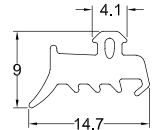
							
Product Code	SL-212	Product Code	SL-207	Product Code	SL-211	Product Code	SL-208
Description	100mm Corner Jointer	Description	120mm Corner Jointer	Description	100mm Straight Jointer	Description	120mm Straight Jointer
							
Product Code	SL-209	Product Code	SL-210	Product Code	SL-198	Product Code	SL-199
Description	100mm Post Bracket	Description	120mm Post Bracket	Description	100mm Post Anchor	Description	120mm Post Anchor
							
Product Code	SL-200	Product Code	SL-206	Product Code	SL-203	Product Code	SL-205
Description	150mm Post Anchor	Description	80x80mm Frame Bracket	Description	100x44mm Frame Bracket	Description	100x50mm Frame Bracket
							
Product Code	SL-202	Product Code	SL-204	Product Code	SL-201	Product Code	Screw
Description	100x100mm Frame Bracket	Description	120x60mm Frame Bracket	Description	120x120mm Frame Bracket	Description	HEX Washer Head M5.5x25mm
							
Product Code	PC Endurance Board Sealer 2	Product Code	PC Endurance Board Sealer 1	Product Code	PC Endurance Board Sealer 3	Product Code	NZJT-022
Description		Description		Description		Description	4.2mm PC Board Rubber

Aluminium Roofing System

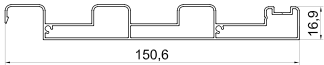
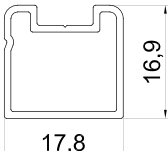
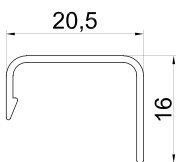
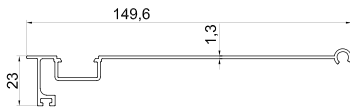
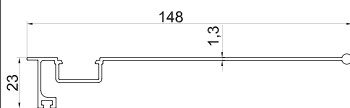
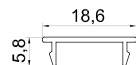
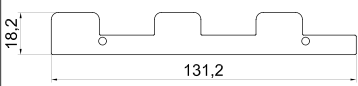
							
Product Code	GM-NEWZ-CCB01	Product Code	GM-NEWZ-CCB02	Product Code	GM-NEWZ-CCB03	Product Code	GM-NEWZ-CCB04
Description	1.065	Description	0.192	Description	0.116	Description	0.781
							
Product Code	GM-NEWZ-CCB05	Product Code	GM-NEWZ-CCB06	Product Code	GM-NEWZ-CCB07		
Description	0.779	Description	0.074	Description	0.074		

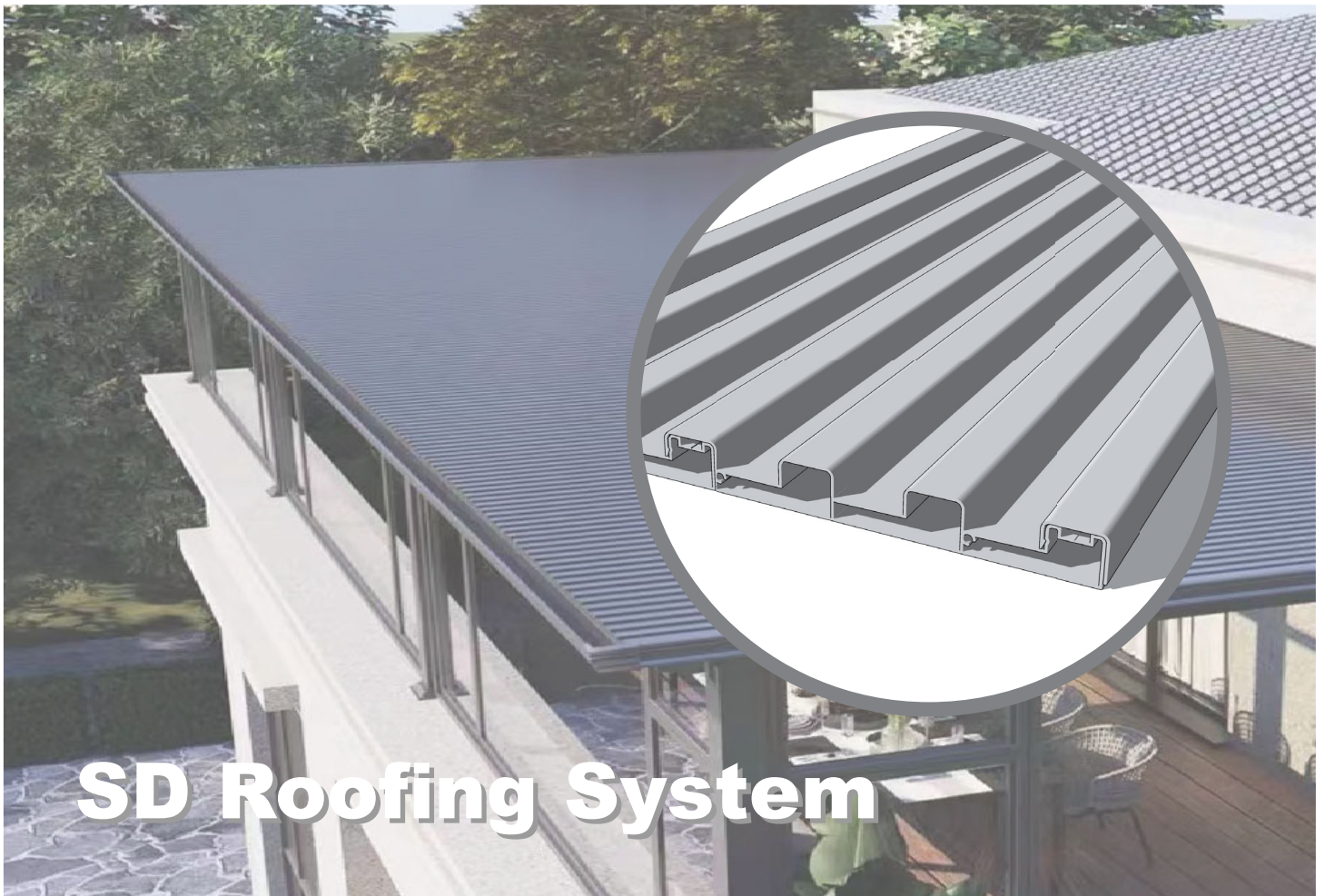

SD Roofing System

Product Code	GM-BGM-A01	Product Code	GM-BGM-A02	Product Code	GM-BGM-A03	Product Code	GM-BGM-A04
Weight (Kg/m)	0.513	Weight (Kg/m)	0.388	Weight (Kg/m)	0.310	Weight (Kg/m)	0.420
Product Code	GM-BGM-A05	Product Code	GM-BGM-A06	Product Code	GM-BGM-A07	Product Code	GM-BGM-A08
Weight (Kg/m)	0.692	Weight (Kg/m)	0.520	Weight (Kg/m)	0.235	Weight (Kg/m)	0.550
Product Code	GM-BGM-A09	Product Code	GM-BGM-A10	Product Code	GM-BGM-A11	Product Code	GM-BGM-A12
Weight (Kg/m)	0.733	Weight (Kg/m)	0.920	Weight (Kg/m)	0.714	Weight (Kg/m)	1.08
Product Code	GM-BGM-A13	Product Code	GM-BGM-A14	Product Code	GM-BGM-A15	Product Code	GM-BGM-B01
Weight (Kg/m)	0.523	Weight (Kg/m)	0.430	Weight (Kg/m)	0.580	Weight (Kg/m)	0.700
Product Code	GM-BGM-B02	Product Code	GM-BGM-B03	Product Code	GM-BGM-B04	Product Code	GM-BGM-B05
Weight (Kg/m)	0.450	Weight (Kg/m)	0.248	Weight (Kg/m)	0.466	Weight (Kg/m)	0.681

							
Product Code	GM-BGM-B06	Product Code	GM-NEWZ-42	Product Code	GM-NEWZ-43	Product Code	GM-NEWZ-44
Weight (Kg/m)	0.331	Weight (Kg/m)	0.114	Weight (Kg/m)	0.107	Weight (Kg/m)	0.094
							
Product Code	GM-NEWZ-41	Product Code	GM-NEWZ-40	Product Code	GM-NEWZ-34.5x12x1.2R	Product Code	SL76
Weight (Kg/m)	0.360	Weight (Kg/m)	0.518	Weight (Kg/m)	0.300	Description	Rail End Support - Square
							
Product Code	GM-NEWZ-66	Product Code	SL73	Product Code	SL81SP	Product Code	SL81
Weight (Kg/m)	0.268	Description	Rail End Support - Round	Description	Rail End Support	Description	Rail Centre Support
							
Product Code	SL04	Product Code	SL05	Product Code	SL14	Product Code	SL110
Description	L Shape Handke Cap	Description	U Shape Handke Cap	Description	L / U Shape Handle	Description	Cabinet Feet
							
Product Code	C1202-A1						
Description	Shelf Support						

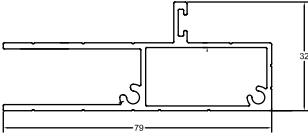
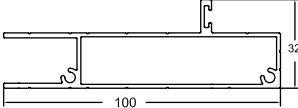
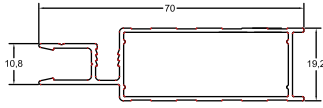
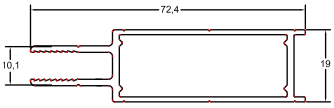
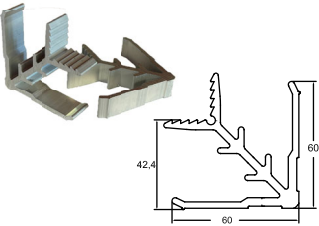
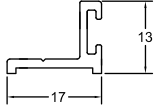
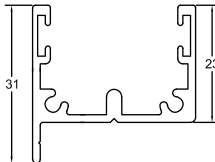
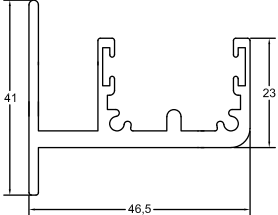
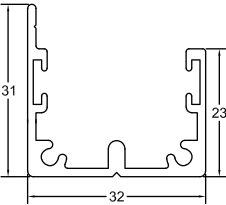
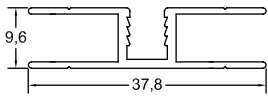
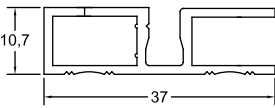
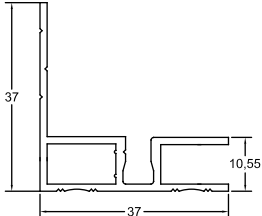
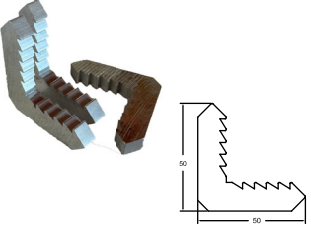
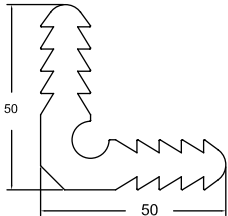
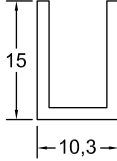
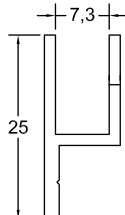
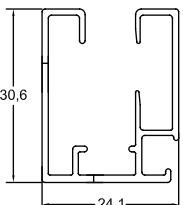
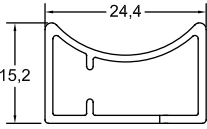
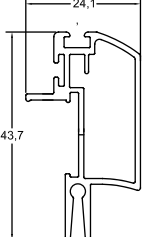
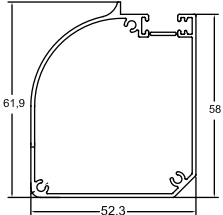
							
Product Code	GM-NEWZ-W24	Product Code	GM-NEWZ-W28	Product Code	GM-NEWZ-W25	Product Code	GM-NEWZ-W26
Weight (Kg/m)	1.022	Weight (Kg/m)	1.150	Weight (Kg/m)	0.564	Weight (Kg/m)	0.750
							
Product Code	GM-NEWZ-W27	Product Code	GM-NEWZ-W29	Product Code	GM-NEWZ-W30	Product Code	GM-NEWZ-W31
Weight (Kg/m)	2.410	Weight (Kg/m)	0.1	Weight (Kg/m)	0.510	Weight (Kg/m)	0.984
							
Product Code	GM-NEWZ-W32	Product Code	GM-NEWZ-W33	Product Code	GM-NEWZ-W34	Product Code	GM-NEWZ-W35
Weight (Kg/m)	0.510	Weight (Kg/m)	0.273	Weight (Kg/m)	0.370	Weight (Kg/m)	0.474
							
Product Code	GM-NEWZ-W36	Product Code	GM-NEWZ-W37	Product Code	CLSA10.3B15T1.5	Product Code	GM-NEWZ-151
Weight (Kg/m)	2.805	Weight (Kg/m)	2.493	Weight (Kg/m)	0.160	Weight (Kg/m)	0.217
							
Product Code	GM-NEWZ-84	Product Code	GM-NEWZ-85	Product Code	GM-NEWZ-86	Product Code	GM-NEWZ-87
Weight (Kg/m)	0.390	Weight (Kg/m)	0.264	Weight (Kg/m)	0.500	Weight (Kg/m)	0.830

				<p>Wall Mount Channel for: NEWZ-24 & NEWZ-28</p>	
Product Code	GM-NEWZ-91	Product Code	GM-NEWZ-89	Product Code	CLA16B16T1.6
Weight (Kg/m)	0.233	Weight (Kg/m)	0.970	Weight (Kg/m)	0.204

Security Grilles & Meshes

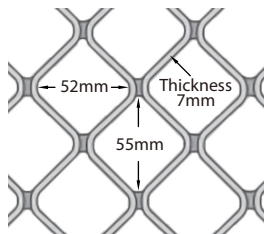

Aluminium 52x55 Grille

Product Description	Thickness (mm)	Size (mm)
52x55 Security Grille	7.00	750 x 2000
		750 x 4000
		920 x 2000
		920 x 4000
		1250 x 2000
		1250 x 4000

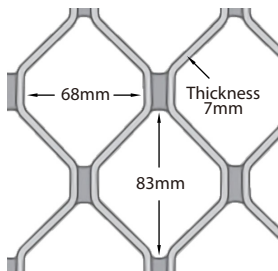

Aluminium 68x83 Grille

Product Description	Thickness (mm)	Size (mm)
68x83 Security Grille	7.00	750 x 2000
		750 x 4000
		920 x 2000
		920 x 4000
		1250 x 2000
		1250 x 4000

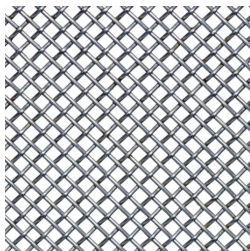

316 Marine Grade Stainless Steel Mesh
0.80mm Thickness

Product Description	Thickness (mm)	Size (mm)
Perforated Screen	0.80	750 x 2000
		750 x 4000
		920 x 2000
		920 x 4000
		1250 x 2000
		1250 x 4000

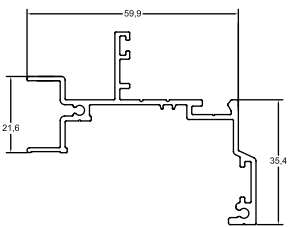
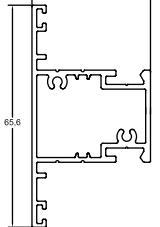
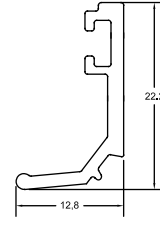
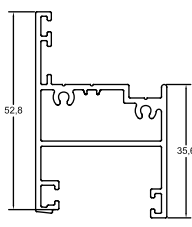
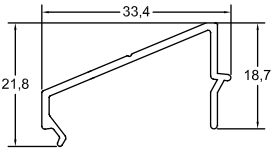
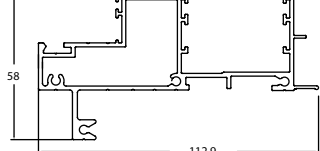
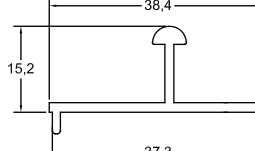
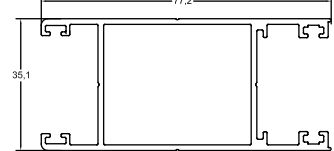
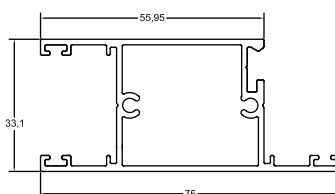
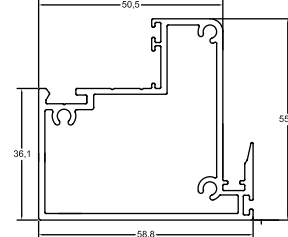
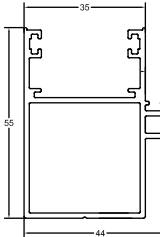
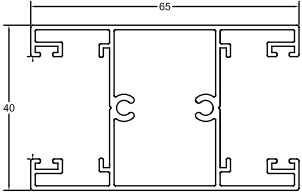
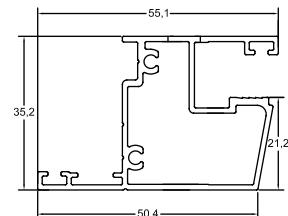
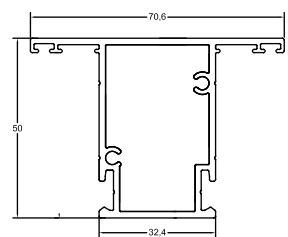
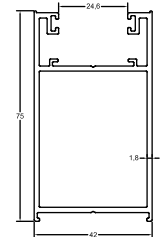
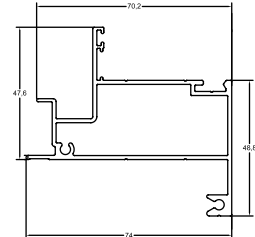
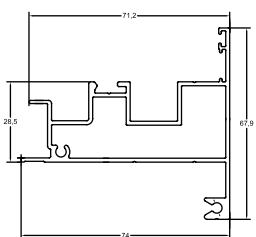
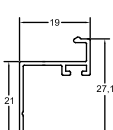
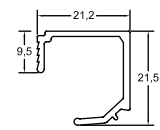
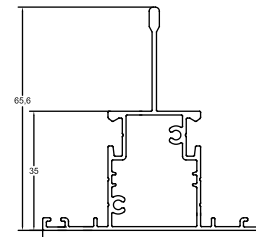
							
Product Code	GM-NEWZ-W01	Product Code	GM-NEWZ-W02	Product Code	GM-NEWZ-W03	Product Code	GM-NEWZ-W04
Weight (Kg/m)	0.771	Weight (Kg/m)	0.875	Weight (Kg/m)	0.175	Weight (Kg/m)	0.824
							
Product Code	GM-NEWZ-W05	Product Code	GM-NEWZ-W06	Product Code	GM-NEWZ-W07	Product Code	GM-NEWZ-W08
Weight (Kg/m)	0.230	Weight (Kg/m)	1.830	Weight (Kg/m)	0.310	Weight (Kg/m)	1.100
							
Product Code	GM-NEWZ-W09	Product Code	GM-NEWZ-W10	Product Code	GM-NEWZ-W11	Product Code	GM-NEWZ-W12
Weight (Kg/m)	0.970	Weight (Kg/m)	1.310	Weight (Kg/m)	1.000	Weight (Kg/m)	1.030
							
Product Code	GM-NEWZ-W21	Product Code	GM-NEWZ-W13	Product Code	GM-NEWZ-W14	Product Code	GM-NEWZ-W15
Weight (Kg/m)	0.755	Weight (Kg/m)	1.180	Weight (Kg/m)	1.330	Weight (Kg/m)	1.190
		  GM-NEWZ-W17 0.162 GM-NEWZ-W18 0.235					
Product Code	GM-NEWZ-W16	Product Code	GM-NEWZ-W17 / 18	Product Code	GM-NEWZ-W20		
Weight (Kg/m)	1.260	Weight (Kg/m)	0.162 & 0.235	Weight (Kg/m)	0.855		

"✓" Stocked Item
 "*" Pre-order Only Item
 (30-40 working days delivery)



Window Support Bars

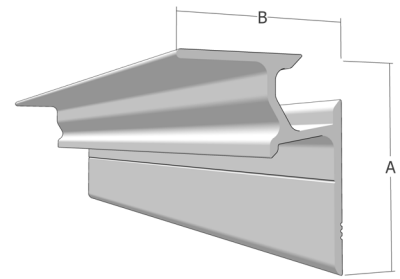

Product Code	Ex Stock	A (mm)	B (mm)	Mass (kg/m)	Perimeter (Kg/m)	Area (mm ²)
GM-NEWZ-99	✓	50	20	0.50	163.28	174.78
GM-NEWZ-17	✓	50	30	0.57	183.27	200.00
GM-NEWZ-16	✓	50	40	0.63	203.28	220.56
GM-NEWZ-15	✓	60	50	0.76	243.40	266.70

Top-Fix Support Bars

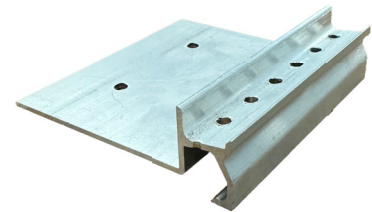

Product Code	Ex Stock	A (mm)	B (mm)	C (mm)	Mass (kg/m)	Perimeter (Kg/m)	Area (mm ²)
GM-NEWZ-19	✓	19	22.8	23.2	0.810	274.74	384.37
GM-NEWZ-20	✓	30	22.8	23.2	0.868	294.65	304.59
GM-NEWZ-21	✓	40	24.8	23.2	1.040	319.17	364.91
GM-NEWZ-22	✓	55	24.8	23.2	1.130	349.17	396.66

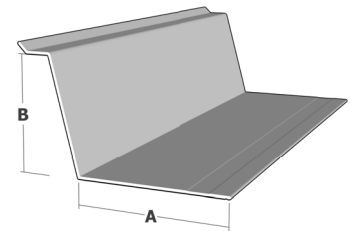

Head Flashings



Product Code	Ex Stock	A (mm)	B (mm)	Surface Treatment	Length (m)
GM-NEWZ-187	✓	66	20	Matt Black, Matt Ironsand, Matt Titania, Silver Pearl, Matt Charcoal, Matt Sandstone Grey	6
GM-NEWZ-188	✓	66	30		6
GM-NEWZ-189	✓	66	40		6
GM-NEWZ-124	✓	66	50		6
GM-NEWZ-18	✓	66	60		6
GM-NEWZ-10	✓	66	70		6
GM-NEWZ-75	✓	66	85		6

 <p>Max Sash Height: 750mm Max Sash Weight: 6kg</p>		 <p>Max Sash Height: 1000mm Max Sash Weight: 9kg</p>		 <p>Max Sash Height: 1300mm Max Sash Weight: 12kg</p>		 <p>Max Window Opening: 100mm</p>	
Product Code	BA230B/BP235B	Product Code	BA330B/BP335B	Product Code	BA500B/BP510B	Product Code	SL101
Description	235mm Friction Stay	Description	330mm Friction Stay	Description	510mm Friction Stay	Description	Safety Stay
		 <p>Zinc Alloy Comes in White & Matt Black</p>		 <p>Zinc Alloy Comes in White & Matt Black</p>			
Product Code	MS07	Product Code	MS01	Product Code	MS03	Product Code	MY01
Description	Locker Cylinder	Description	Flat Trim Lever Handle Locker	Description	Sliding Door Locker	Description	Security Hinge
				 <p>Sliding</p>		 <p>4.7 Clear 7.08 10.26</p>	
Product Code	MY01	Product Code	MS10	Product Code	MS11	Product Code	NZJT-001
Description	Sliding Door Carridge	Description	Trim Lever Handle Lock	Description	Sliding 3-point Lock	Description	
 <p>4.9 Clear 9.5 8.83</p>		 <p>4.9 Clear 8.81</p>		 <p>4.9 Clear 7 10.04</p>		 <p>4.2 Blue 9.4 4.4 Compressed Size: 2.0mm</p>	
Product Code	NZJT-002	Product Code	NZJT-003	Product Code	NZJT-004	Product Code	NZJT-005
Description		Description		Description		Description	PVC Low Rise Wedge
 <p>5.26 Red 9.6 5.6 3.00 Compressed Size: 3.5mm</p>		 <p>6 Orange 10 6.2 8 Compressed Size: 4.0mm</p>		 <p>11 Yellow 6.5 Compressed Size: 4.5mm</p>		 <p>11 White 7 Compressed Size: 5.0mm</p>	
Product Code	NZJT-006	Product Code	NZJT-007	Product Code	NZJT-021	Product Code	NZJT-008
Description	PVC Low Rise Wedge	Description	PVC Low Rise Wedge	Description	PVC Low Rise Wedge	Description	PVC Low Rise Wedge

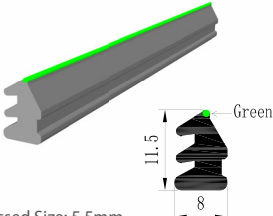
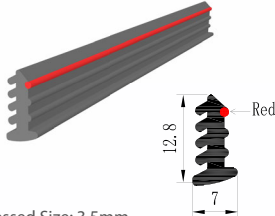
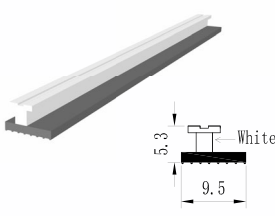
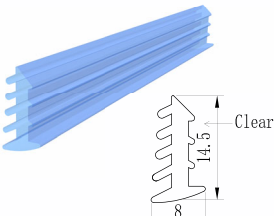
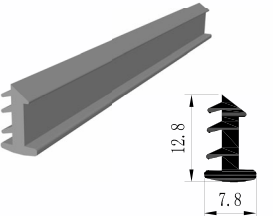
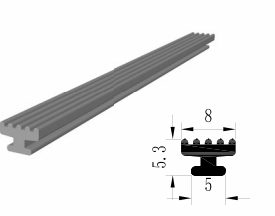
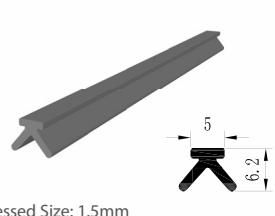
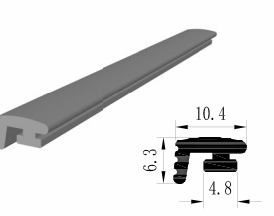
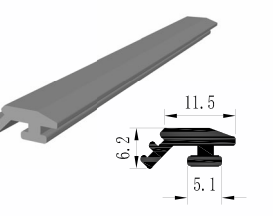
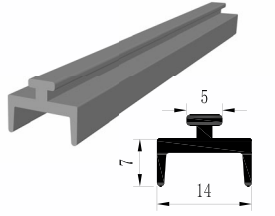
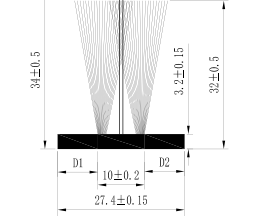
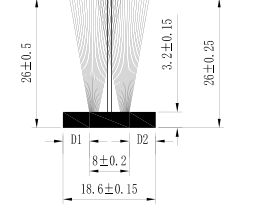

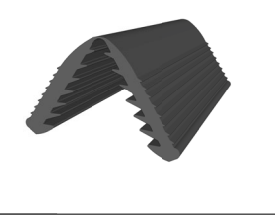
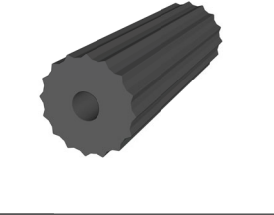
Window & Door Accessories

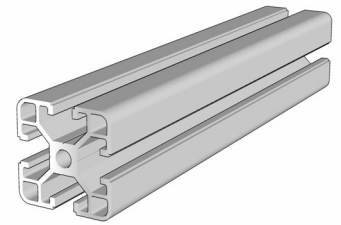
 <p>Compressed Size: 5.5mm</p>		 <p>Compressed Size: 3.5mm</p>					
Product Code	NZJT-009	Product Code	NZJT-010	Product Code	NZJT-012	Product Code	NZJT-013
Description	8.0mm Low Rise Wedge	Description	PVC Wedge Rubber	Description		Description	Clear PVC Wedge
				 <p>Compressed Size: 1.5mm</p>			
Product Code	NZJT-014	Product Code	NZJT-015	Product Code	NZJT-016	Product Code	NZJT-017
Description		Description		Description	TPV Seal	Description	
							
Product Code	NZJT-018	Product Code	NZJT-019	Product Code	MT-006	Product Code	MT-007
Description		Description		Description	34mm Fin Pile Weather Strip	Description	26mm Fin Pile Weather Strip
							
Product Code	SL-01	Product Code	SL-02	Product Code	SL-197 / NZJT - 023	Product Code	SL-198 / NZJT - 024
Description	Supporting Bar Gasket	Description	Head Flashing Gasket	Description	Rubber for 316 Steel Mesh	Description	Rubber for Fly Screen Mesh

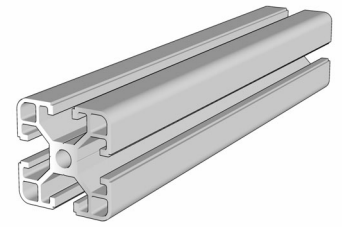

<p>20x20mm T-Slot</p>		<p>20x40mm T-Slot</p>		<p>20x80mm T-Slot</p>		<p>30x30mm T-Slot</p>	
Product Code	GM-LZ-83	Product Code	GM-LZ-85	Product Code	GM-LZ-117	Product Code	GM-LZ-86
Weight (Kg/m)	0.470	Weight (Kg/m)	0.844	Weight (Kg/m)	1.570	Weight (Kg/m)	0.930
<p>30x60mm T-Slot</p>		<p>30x30mm T-Slot Corner</p>		<p>40x40mm T-Slot</p>		<p>40x40mm T-Slot Corner</p>	
Product Code	GM-LZ-87	Product Code	GM-LZ-97	Product Code	GM-LZ-89	Product Code	GM-LZ-96
Weight (Kg/m)	1.700	Weight (Kg/m)	0.842	Weight (Kg/m)	1.353	Weight (Kg/m)	1.380
<p>40x80mm T-Slot Corner</p>		<p>40x120mm T-Slot</p>		<p>40x160mm T-Slot</p>		<p>40x160mm T-Slot</p>	
Product Code	GM-LZ-82	Product Code	GM-GYFZ-78	Product Code	GM-LZ-278	Product Code	GM-GYFZ-62
Weight (Kg/m)	2.313	Weight (Kg/m)	3.610	Weight (Kg/m)	5.750	Weight (Kg/m)	6.800
<p>50x50mm T-Slot</p>		<p>50x50mm T-Slot Corner</p>		<p>60x60mm T-Slot</p>		<p>80x80mm T-Slot</p>	
Product Code	GM-LZ-78	Product Code	GM-GYFZ-76	Product Code	GM-LZ-168	Product Code	GM-LZ-263
Weight (Kg/m)	2.524	Weight (Kg/m)	1.980	Weight (Kg/m)	2.590	Weight (Kg/m)	4.670
<p>80x120mm T-Slot</p>		<p>80x160mm T-Slot</p>		<p>120x120mm T-Slot</p>			
Product Code	GM-GYFZ-003	Product Code	GM-LZ-21	Product Code	GM-GYFZ-67		
Weight (Kg/m)	7.000	Weight (Kg/m)	9.620	Weight (Kg/m)	10.400		

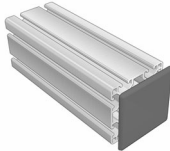

							
Product Code	XXXXXX	Product Code		Product Code		Product Code	
Description	20x20 T-Slot End Cap	Description	20x40 T-Slot End Cap	Description	20x80 T-Slot End Cap	Description	30x30 T-Slot End Cap
							
Product Code		Product Code		Product Code		Product Code	
Description	30x60 T-Slot End Cap	Description	40x40 T-Slot End Cap	Description	40x80 T-Slot End Cap	Description	40x160 T-Slot End Cap
							
Product Code		Product Code		Product Code		Product Code	
Description	50x50 T-Slot End Cap	Description	60x60 T-Slot End Cap	Description	80x80 T-Slot End Cap	Description	80x120 T-Slot End Cap
							
Product Code		Product Code		Product Code	TS35	Product Code	TS36
Description	80x160 T-Slot End Cap	Description	120x120 T-Slot End Cap	Description	20mm T-Slot Bracket	Description	30mm T-Slot Bracket
							
Product Code	TS37	Product Code	TS38	Product Code	TS39	Product Code	TS42
Description	30x60mm T-Slot Bracket	Description	40mm T-Slot Bracket	Description	40x80mm T-Slot Bracket	Description	45x45mm T-Slot Bracket

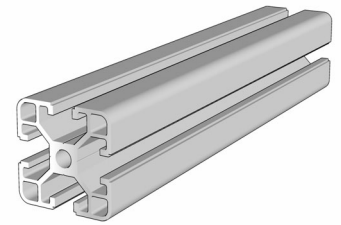

Product Code	TS40	Product Code	TS41	Product Code	TS03	Product Code	SP19-1
Description	60x60mm T-Slot Bracket	Description	80mm T-Slot Bracket	Description	Wheel Base Plate	Description	T-Slot Wheel
Product Code	SP19-2	Product Code		Product Code	TS42	Product Code	NZJT-025
Description	T-Slot Wheel with break	Description	30mm 3-way Jointer	Description	40mm 3-way Jointer	Description	30 / 40mm Sealing Strip
Product Code	NZJT-027	Product Code	NZJT-028	Product Code	NZJT-026	Product Code	SL-226
Description	60mm Sealing Strip	Description	40mm Sealing Strip	Description	20mm Sealing Strip	Description	HD Corner Stake for 30x60
for 40x80mm T-Slot		for 40x120mm T-Slot		for 120x120mm T-Slot		for 30/40mm T-Slot M6 Screw	
Product Code	SL-227	Product Code	SL-228	Product Code	SL-229	Product Code	SL-230
Description	HD Corner Stake for 40x80	Description	HD Corner Stake for 40x120	Description	HD Corner Stake for 120x120	Description	Shrapnel Nut for M6 Screw
for 30/40mm T-Slot M8 Screw		for 30x60mm system		for 40x80mm system		Comes with Sliding Nut Screws, and Round Nut	
Product Code	SL-231	Product Code	SL-232	Product Code	SL-233	Product Code	SL-234
Description	Shrapnel Nut for M8 Screw	Description	30x60mm Joint Plate	Description	40x80mm Joint Plate	Description	30mm Internal Joint Set

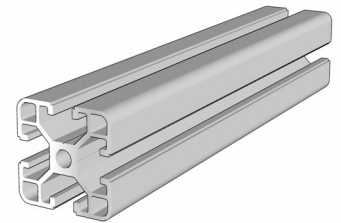

 <p>Comes with Sliding Nut Screws, and Round Nut</p>		 <p>Comes with Screws</p>		 <p>Comes with Screws</p>		 <p>Comes with Screws</p>	
Product Code	SL-235	Product Code	SL-236	Product Code	SL-237	Product Code	SL-238
Description	40mm Internal Joint Set	Description	20mm Internal Corner Jointer	Description	30mm Internal Corner Jointer	Description	40mm Internal Corner Jointer
 <p>Comes with Screws</p>		 <p>Comes with Screws</p>		 <p>Comes with Screws</p>		 <p>Comes with Screws</p>	
Product Code	SL-239	Product Code	SL-240	Product Code	SL-241	Product Code	SL-242
Description	20mm Pivot Corner Jointer	Description	30mm Pivot Corner Jointer	Description	40mm Pivot Corner Jointer	Description	30mm 45° Corner Jointer
 <p>Comes with Screws</p>		 <p>Comes with Screws</p>		 <p>Comes with Screws</p>		 <p>Comes with Screws</p>	
Product Code	SL-243	Product Code	SL-244	Product Code	SL-250	Product Code	SL-251
Description	30mm 135° Corner Jointer	Description	40mm 135° Corner Jointer	Description	30mm Hinge	Description	40mm Hinge
 <p>Comes with Screws and Nuts</p>							
Product Code	SL-252						
Description	90mm handle set						

Stair Mouldings

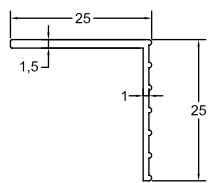
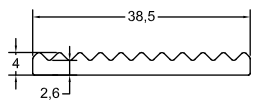
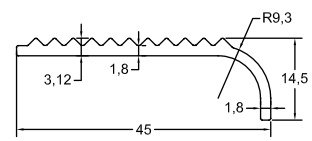
					
Product Code	GM-NEWZ-W39 Fluted Angle	Product Code	GM-NEWZ-W40 Fluted Flat Bar	Product Code	GM-NEWZ-W41 Stair Nosing
Weight (Kg/m)	0.180	Weight (Kg/m)	0.364	Weight (Kg/m)	0.336

Awning Tracks

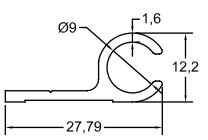
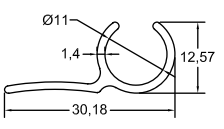
			
Product Code	GM-GFX-70 9mm Sail Track	Product Code	GM-NEWZ-150 11mm Sail Track
Weight (Kg/m)	0.220	Weight (Kg/m)	0.203

Y-Post / Waratah Systems and Mesh Options









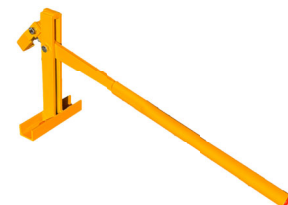

Galvanized Steel Y Posts - Painted Black

Hot-dip galvanisation for maximum corrosion protection in harsh environments. Primarily used for Temporary Fencing, Gardening and Concrete Boxing applications.



Weight: 1.80kg/m approx.

Product Code	Length	Holes
SYP0.45M	450mm	2
SYP0.6M	600mm	3
SYP0.8M	800mm	5
SYP0.9M	900mm	5
SYP1.2M	1200mm	11
SYP1.35M	1350mm	11
SYP1.5M	1500mm	14
SYP1.65M	1650mm	14
SYP1.8M	1800mm	14
SYP2.4M	2400mm	17
SYP2.7M	2700mm	17
SYP3M	3000mm	17

							
Product Code	SL-45	Product Code	SL-47	Product Code	SL-20	Product Code	SL-21
Description	Post Rammer	Description	Post Lifter	Description	Round Safety Cap	Weight (Kg/m)	Triangle Safety Cap
		 Wire Diametre: 2.0mm Vertical Spacing: 140mm 1.2m(Height) X 50m(Length)		 Wire Diametre: 2.0mm Vertical Spacing: 140mm 1.5m (Height) X 50m (Length)		 Wire Diametre: 2.5mm Diamond Spacing: 50x50mm 0.9m (Height) X 20m (Length)	
Product Code	GM-GYFZ-67	Product Code	FSFH1.2L50	Product Code	FSFH1.5L50	Product Code	CFH0.9L20
Description	Wire Strainer	Description	Sheep Fence Mesh	Description	Sheep Fence Mesh	Description	Chain Link Fence Mesh
 Wire Diametre: 2.5mm Diamond Spacing: 50x50mm 0.9m(Height) X 20m(Length)		 Weight: 100g/m ² 1m(Height) X 50m(Length)		 Hot Dip Galvanized Net 25 0.9m(Height) X 9m(Length)		 Hot Dip Galvanized Net 13 1m(Height) X 9m(Length)	
Product Code	CFH0.9L20PVC	Product Code	SMW1L50RED	Product Code	SWWFH0.914NS25L9	Product Code	SWWFH1NS13L9
Description	PVC Chain Link Fence Mesh	Description	Orange Safety Mesh	Description	Galvanized Square Wire Mesh	Description	Galvanized Square Wire Mesh

Temporary Fence Panel

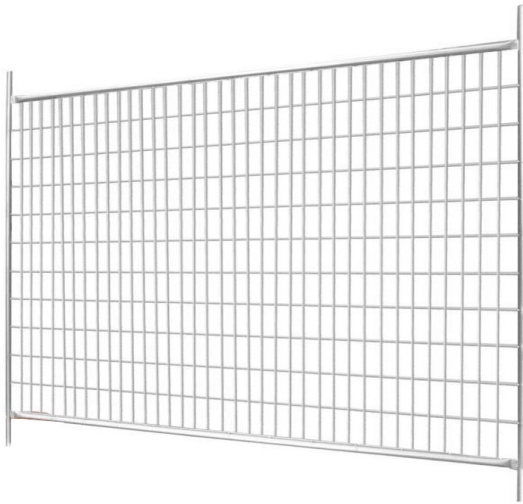

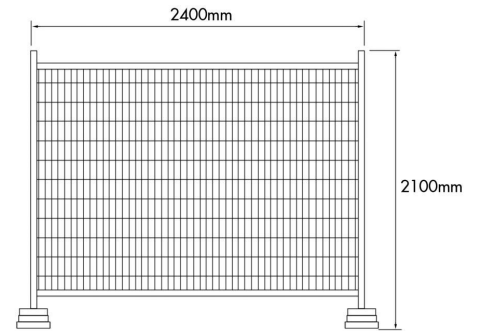

Product Code	Panel Size
TFSH2.1L2.4	2.4m (W) X 2.1m (H)

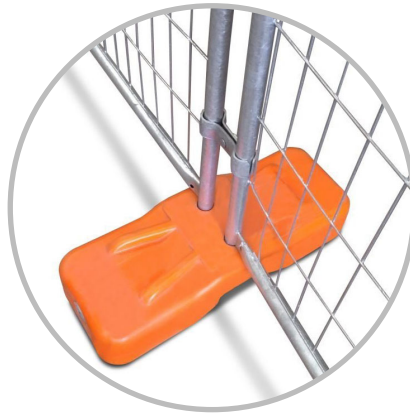

Finish: 14 micron galvanized steel finish
 Mesh: 150mm X 60mm mesh spacing
 2.5mm thickness wire mesh





Hot-dip galvanisation for maximum corrosion protection in harsh environments.
 Primarily used for Civil Construction Projects, Sport Events and Environmental Protection applications.

					
Product Code	SL-71	Product Code	SL-72	Product Code	TFBH2.1L2.4
Description	Concrete Filled Foot	Description	Panel Clamp	Description	Panel Bracing

							
Product Code	HD108	Product Code	HD101	Product Code	SS850	Product Code	SS511B
Description	Kitchen and Bathroom Sealant	Description	General Purpose Sealant	Description	Window and Door Sealant	Description	Silicone Sealant
							
Product Code	Sealant Gun 1	Product Code	Sealant Gun 2	Product Code	GC5	Product Code	GC6
Description		Description	For SS511B Silicone Sealant	Description	5" - 125mm G Clamp	Description	6" - 150mm G Clamp
							
Product Code	GC10	Product Code	GC9	Product Code	SL80	Product Code	SL79
Description	10" - 250mm G Clamp	Description	F Heavy Duty Clamp	Description	Handy Wrap Handle	Description	Stretch Wrap Film - S
							
Product Code	Stretch Wrap PE	Product Code	PVC -75mmx50m	Product Code	PVC -48mmx50m	Product Code	PVC -36mmx50m
Description	Stretch Wrap Film - L	Description	75mm PVC Orange Tape	Weight (Kg/m)	48mm PVC Orange Tape	Weight (Kg/m)	36mm PVC Orange Tape





CSK Head - Self Tapping Screw 304 Stainless Steel

Drive Type	Code	Gauge	Thread Diameter	Length
 Square Drive	D49	5g	M3.3	17mm
	D4	8g	M4.2	25mm
 Philips Drive	D58	8g	M4.2	38mm
	D57	8g	M4.2	50mm
	D59	8g	M4.2	60mm
 Int Hex Drive	D3	12g	M5.5	40mm
	D2	14g	M6.3	50mm
	D1	20g	M8	50mm
	D54	20g	M8	55mm



CSK Head - Self Drilling Screw 304 Stainless Steel

Drive Type	Code	Gauge	Thread Diameter	Length
 Square Drive	D42	7g	M4	11mm
	D48	8g	M4.2	19mm
	D30	10g	M4.8	25mm
	D30 (Black)	10g	M4.8	25mm
	D31	10g	M4.8	38mm
 Int Hex Drive	D29 (Black)	12g	M5.5	19mm
 Philips Drive	D26	12g	M5.5	25mm





CSK Head - Dog Point Screw 304 Stainless Steel

Drive Type	Code	Gauge	Thread Diameter	Length
 Square Drive	D37 (Black)	6g	M3.5	17mm
	D38 (Black)	6g	M3.5	24mm
	D39	6g	M3.5	25mm





PAN Head - Self Tapping Screw 304 Stainless Steel

Drive Type	Code	Gauge	Thread Diameter	Length
 Square Drive	D35	6g	M3.5	19mm
	D40	6g	M3.5	37mm
	D41	6g	M3.5	50mm
	D33	8g	M4.2	19mm
	D5	8g	M4.2	25mm
	D46	8g	M4.2	38mm
	D32	8g	M4.2	50mm
	D45	8g	M4.2	76.2mm
	D47	10g	M4.8	55mm
	D56	12g	M5.5	25mm
 Philips Drive	D26	12g	M5.5	25mm



PAN Head - Self Drilling Screw 304 Stainless Steel

Drive Type	Code	Gauge	Thread Diameter	Length
 Philips Drive	D22	8g	M4.2	16mm
	D23	8g	M4.2	19mm
	D52	10g	M5	40mm
 Square Drive	D34	8g	M4.2	19mm



PAN Head - Dog Point Screw 304 Stainless Steel

Drive Type	Code	Gauge	Thread Diameter	Length
 Square Drive	D36	6g	M3.5	19mm
	D43	6g	M4.2	7mm
	D44 (Black)	6g	M4.2	7mm
	D60		M4.2	25mm





CSK Head - Self Tapping Screw Steel

Drive Type	Code	Gauge	Thread Diameter	Length
 Square Drive	D21	6g	M3.5	16mm
	D20	7g	M4	28mm
	D19	7g	M4	32mm
	D18	7g	M4	38mm
	D17	7g	M4	50mm
	D16	7g	M4	65mm
	D14	10g	M5	88mm
	D15 (Black)	10g	M5	88mm



Truss Head - Self Drilling Screw 304 Stainless Steel

Drive Type	Code	Gauge	Thread Diameter	Length
 Square Drive	D50	8g	M4.2	19mm
	D51	8g	M4.2	25mm
 Phillips Drive	D6 Galvanized Steel	10g	M4.8	16mm
	D7 Galvanized Steel	7g	M4	220mm



HEX Washer Head - Self Drilling Screw 304 Stainless Steel

Drive Type	Code	Gauge	Thread Diameter	Length
 Washer Drive	D8	10g	M4.8	50mm
	D9 (Black)	12g	M5.5	25mm
	D10 (Black)	12g	M5.5	30mm
	D11 (Black)	12g	M5.5	35mm
	D24 (Black)	12g	M5.5	16mm
	D25 (Black)	12g	M5.5	38mm
	D12	12g	M5.5	55mm

"✓" Stocked Item
 "✱" Pre-order Only Item
 (30-40 working days delivery)



Galvanized Steel Round Tubes



Product Code	Ex Stock	O.D (mm)	T (mm)	Mass (kg/m)	Length (m)
RD19T1.3GALV	✱	19.0	1.2	0.294	6.0
RD20T1.5GALV	✓	20.0	1.5	0.684	6.0
RD21T2.2GALV	✓	21.0	2.2	1.021	6.0
RD25T2GALV	✓	25.0	2.0	1.134	6.0
RD25.4T1.2GALV	✱	25.4	1.2	0.692	6.0
RD26T2.2GALV	✓	26.0	2.2	1.291	6.0
RD32T2.2GALV	✓	32.0	2.2	1.617	6.0
RD48T3GALV	✓	48.0	3.0	3.329	6.0
RD60T3.5GALV	✓	60.0	3.5	4.877	6.0
RD76T3.25GALV	✓	76.0	3.25	5.831	6.0
RD114T3.25GALV	✓	114.0	3.25	8.876	6.0
RD165T3.5GALV	✓	165.0	3.5	13.939	6.0

"✓" Stocked Item
 "✱" Pre-order Only Item
 (30-40 working days delivery)



Galvanized Steel Square Hollow

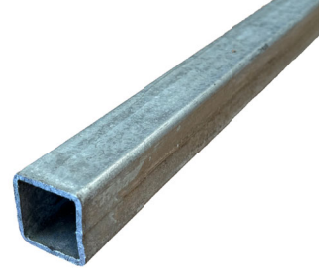

Product Code	Ex Stock	A (mm)	T (mm)	R (mm)	Mass (kg/m)	Length (m)
SHA20T1.5GALV	✓	20.0	1.5	2.0	0.818	6.0
SHA25T1.5GALV	✓	25.0	1.5	2.0	1.080	6.0
SHA25T2GALV	✓	25.0	2.0	2.0	1.463	6.0
SHA25T2.5GALV	✱	25.0	2.5		1.789	6.0
SHA25T3GALV	✱	25.0	3.0		2.099	6.0
SHA30T1.6GALV	✱	30.0	1.6		1.445	6.0
SHA30T2GALV	✓	30.0	2.0	2.0	1.789	6.0
SHA30T2.5GALV	✱	30.0	2.5		2.099	6.0
SHA40T1.6GALV	✱	40.0	1.6		1.954	6.0
SHA40T2R3GALV	✓	40.0	2.0	3.0	2.471	6.0
SHA40T2.5R3GALV	✓	40.0	2.5	3.0	2.981	6.0
SHA40T3GALV	✱	40.0	3.0		3.530	6.0
SHA40T4GALV	✱	40.0	4.0		4.579	6.0
SHA50T1.6GALV	✱	50.0	1.6		2.463	6.0
SHA50T2R3GALV	✓	50.0	2.0	3.0	3.053	6.0
SHA50T2.5GALV	✱	50.0	2.5		3.776	6.0
SHA50T3GALV	✱	50.0	3.0		4.484	6.0
SHA50T3R3GALV	✓	50.0	3.0	3.0	4.423	6.0
SHA50T4GALV	✱	50.0	4.0		5.851	6.0
SHA50T5GALV	✓	50.0	5.0		7.155	6.0
SHA65T1.6GALV	✱	65.0	1.6		3.226	6.0
SHA65T2.75R3GALV	✓	65.0	2.75	3.0	5.315	6.0
SHA65T3GALV	✱	65.0	3.0		5.915	6.0
SHA65T4GALV	✱	65.0	4.0		7.759	6.0
SHA65T5GALV	✱	65.0	5.0		9.540	6.0
SHA75T2.5GALV	✱	75.0	2.5		5.764	6.0
SHA75T3GALV	✱	75.0	3.0		6.869	6.0
SHA75T3R3GALV	✓	75.0	3.0	3.0	6.808	6.0
SHA75T4GALV	✱	75.0	4.0		9.031	6.0
SHA75T5GALV	✓	75.0	5.0		11.130	6.0
SHA89T3.5GALV	✱	89.0	3.5		9.516	6.0
SHA89T5GALV	✱	89.0	5.0		13.356	6.0
SHA89T6GALV	✱	89.0	6.0		15.836	6.0
SHA90T3R3GALV	✓	90.0	3.0	3.0	7.860	6.0
SHA90T4.75GALV	✓	90.0	4.75		12.286	6.0
SHA100T3GALV	✱	100.0	3.0		9.254	6.0
SHA100T3R3GALV	✓	100.0	3.0	3.0	9.193	6.0
SHA100T4GALV	✱	100.0	4.0		12.211	6.0
SHA100T5GALV	✓	100.0	5.0		15.105	6.0
SHA100T6GALV	✱	100.0	6.0		17.935	6.0

"✓" Stocked Item
 "✱" Pre-order Only Item
 (30-40 working days delivery)



Galvanized Steel Rectangular Hollow



<i>Product Code</i>	<i>Ex Stock</i>	<i>A (mm)</i>	<i>B (mm)</i>	<i>T (mm)</i>	<i>R (mm)</i>	<i>Mass (kg/m)</i>	<i>Length (m)</i>
RHA38B25T2R2GALV	✱	38.0	25.0	2.0	2.0	1.764	6.0
RHA50B25T1.6GALV	✱	50.0	25.0	1.6		2.128	6.0
RHA50B25T2R2GALV	✓	50.0	25.0	2.0	2.0	2.128	6.0
RHA75B25T2R2GALV	✱	75.0	25.0	2.0	2.0	2.887	6.0
RHA100B50T3R3GALV	✓	100.0	50.0	3.0	3.0	6.495	6.0
RHA125B75T3R3GALV	✱	125.0	75.0	3.0	3.0	8.770	6.0
RHA150B50T4R4GALV	✓	150.0	50.0	4.0	4.0	11.592	6.0
RHA150B50T4R4GALV	✱	150.0	75.0	4.0	4.0	13.109	6.0
RHA200B50T4R4GALV	✱	200.0	50.0	4.0	4.0	14.580	6.0
RHA200B75T5R5GALV	✱	200.0	75.0	5.0	5.0	20.655	6.0

“✓” Stocked Item
 “*” Pre-order Only Item
 (30-40 working days delivery)



Galvanized Steel Equal Angle



Product Code	Ex Stock	A (mm)	T (mm)	Mass (kg/m)	Length (m)
EAA20T3GALV	*	20.0	3.0	0.882	6.0
EAA20T5GALV	*	20.0	5.0	1.391	6.0
EAA25T3GALV	✓	25.0	3.0	1.069	6.0
EAA25T5GALV	*	25.0	5.0	1.789	6.0
EAA30T3GALV	✓	30.0	3.0	1.297	6.0
EAA30T5GALV	*	30.0	5.0	2.186	6.0
EAA40T3GALV	✓	40.0	3.0	1.836	6.0
EAA40T5GALV	✓	40.0	5.0	2.981	6.0
EAA50T3GALV	✓	50.0	3.0	2.313	6.0
EAA50T5GALV	✓	50.0	5.0	3.732	6.0
EAA50T6GALV	*	50.0	6.0	4.484	6.0
EAA60T6GALV	*	60.0	6.0	5.375	6.0
EAA63T6GALV	✓	63.0	6.0	5.658	6.0
EAA60T8GALV	✓	75.0	6.0	6.869	6.0
EAA75T8GALV	*	75.0	8.0	8.927	6.0
EAA80T6GALV	✓	80.0	6.0	7.346	6.0
EAA80T8GALV	*	80.0	8.0	9.667	6.0
EAA80T10GALV	*	80.0	10.0	11.925	6.0
EAA100T6GALV	✓	100.0	6.0	9.254	6.0
EAA100T8GALV	✓	100.0	8.0	12.211	6.0
EAA100T10GALV	*	100.0	10.0	15.105	6.0
EAA100T12GALV	*	100.0	12.0	17.935	6.0
EAA125T8GALV	✓	125.0	8.0	15.391	6.0

Galvanized Steel Unequal Angle



Product Code	Ex Stock	A (mm)	B (mm)	T (mm)	Mass (kg/m)	Length (m)
UAA100B75T6GALV	✓	100.0	75.0	6.0	12.414	6.0
UAA125B75T10GALV	✓	125.0	75.0	6.0	14.250	6.0
UAA150B100T10GALV	✓	150.0	100.0	10.0	29.381	6.0

"✓" Stocked Item
 "*" Pre-order Only Item
 (30-40 working days delivery)



Galvanized Steel Flat Bar

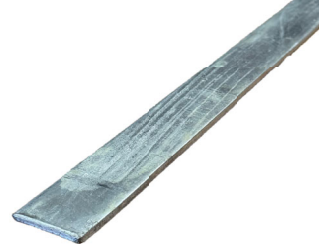

Product Code	Ex Stock	A (mm)	T (mm)	Mass (kg/m)	Length (m)
FBA20T3GALV	*	20.0	3.0	0.455	6.0
FBA20T5GALV	*	20.0	5.0	0.795	6.0
FBA20T6GALV	*	20.0	6.0	0.954	6.0
FBA25T3GALV	✓	25.0	3.0	0.569	6.0
FBA25T5GALV	*	25.0	5.0	0.994	6.0
FBA25T6GALV	*	25.0	6.0	1.193	6.0
FBA30T3GALV	✓	30.0	3.0	0.683	6.0
FBA30T5GALV	*	30.0	5.0	1.193	6.0
FBA30T6GALV	*	30.0	6.0	1.431	6.0
FBA30T8GALV	*	30.0	8.0	1.908	6.0
FBA30T10GALV	*	30.0	10.0	2.385	6.0
FBA40T3GALV	*	40.0	3.0	0.954	6.0
FBA40T4GALV	✓	40.0	4.0	1.214	6.0
FBA40T5GALV	*	40.0	5.0	1.590	6.0
FBA50T4GALV	*	50.0	4.0	1.517	6.0
FBA50T5GALV	✓	50.0	5.0	1.896	6.0
FBA60T6GALV	✓	60.0	6.0	2.829	6.0
FBA80T10GALV	✓	80.0	10.0	6.286	6.0
FBA100T3GALV	*	100.0	12.0	9.430	6.0

ALLOY	TEMPER	Thickness (mm)		Tensile Strength (MPa)				Elongation (% min in 50mm or 5.65 √A)
		Over	Up to	Ultimate		Yield		
				Min	Max	Min	Max	
1350	-H12	All Thicknesses		60				23
2011	-H4	All Thicknesses		275		125		14
2011	-T6	-	25.0	350		220		8
		25.0	75.0	345		220		8
		75.0	-	340		200		8
2014	-T4	-	10.0	370		240		15
		10.0	100.0	385		245		13
		100.0	150.0	385		245		10
		150.0	200.0	370		240		10
2014	-T6	-	10.0	430		385		8
		10.0	25.0	465		415		6
		25.0	100.0	495		450		6
		100.0	150.0	465		415		6
6351	-T4	-	150.0	185		115		16
6351	-T5	All Thicknesses		260		240		8
6351	-T54	-	12.5	205		140		10
6351	-T6	-	150.0	295		255		8
6082	-T4	-	150.0	190		120		14
		150.0	200.0	170		110		11
6082	-T5	-	6.0	270		230		8
6082	-T6	-	20.0	295		255		7
		20.0	150.0	310		270		7
		150.0	200.0	280		240		5
6061	-O _s	All Thicknesses		150		110		14
6061	-T1	-	12.5	180		95		16
6061	-T4	All Thicknesses		180		110		14
6061	-T42	All Thicknesses		180		85		14
6061	-T51	-	16.0	240		205		8
6061	-T6	All Thicknesses		260		240		8
6262	-T6	All Thicknesses		260		240		8
6060	-T0	All Thicknesses		130				16
6060	-T1	-	12.0	115		60		12
		12.0	25.0	110		55		10
6060	-T4			120		60		14
6060	-T591	All Thicknesses		120		75		12
6060	-T5	-	12.0	150		110		6
		12.0	25.0	145		105		6
6060	-T52	-	12.0	150		205		8
SF6060	-T6			205		170		8
6063	-O	All Thicknesses		130				16
6063	-T1	-	12.0	115		60		12
		12.0	25.0	110		55		10
6063	-T4	-	150.0	130		70		12
6063	-T5	-	12.0	150		110		8
		120.0	25.0	145		105		6
6063	-T52	-	12.0	150		205		8

ALLOY	TEMPER	Thickness (mm)		Tensile Strength (MPa)				Elongation (% min in 50mm or 5.65 √A)
		Over	Up to	Ultimate		Yield		
				Min	Max	Min	Max	
6063	-T6	-	25.0	205		170		8
		25.0	150.0	185		160		10
6063	-H112	All Thicknesses		110				13
6106	-T4	-	150.0	130		70		12
6106	-T6	-	10.0	235		210		8
			25.0	205		170		8
		25.0	150.0	185		160		10
6463A	-T1	-	12.0	115		60		12
6463A	-T5	-	12.0	15		110		8
6463A	-T6	-	3.0	205		170		8
		3.0	12.0	205		170		10
6005A	-T4	-	12.0	180		110		14
6005A	-T5	All Thicknesses		260		240		8
6261	-T1	All Thicknesses		190		115		14
6261	-T5	-	5.0	295		255		7
		5.0	10.0	280		240		7
6261	-T6	All Thicknesses		295		255		7
7005	-T53	-	20.0	350		300		10

ALLOY	TEMPER	Thickness (mm)		Tensile Strength (MPa)				Elongation (% min in 50mm or 5.65 √A)
		Over	Up to	Ultimate		Yield		
				Min	Max	Min	Max	
1050	-O	0.15	0.50		95			15
		0.50	0.80		95			20
		0.80	1.30		95			25
		1.30	6.00		95			30
1050	-H12	0.25	0.50	80	110			4
		0.50	0.80	80	110			5
		0.80	1.30	80	110			6
		1.30	2.60	80	110			8
		2.60	6.00	80	110			12
1050	-H14	0.25	0.30	100	125			2
		0.30	0.50	100	125			3
		0.50	0.80	100	125			4
		0.80	1.30	100	125			5
		1.30	2.60	100	125			6
		2.60	12.00	100	125			8
1050	-H16	0.15	0.50	115	140			2
		0.50	0.80	115	140			3
		0.80	1.30	115	140			4
		1.30	4.00	115	140			5
1050	-H18	0.15	0.50	130				1
		0.50	0.80	130				2
		0.80	1.30	130				3
		1.30	1.60	130				4
		1.60	3.25	130				5
1050	-H112	6.00	25.00	60				30
1100	-O	0.15	0.50	75	105	25		15
		0.50	0.80	75	105	25		20
		0.80	1.30	75	105	25		25
		1.30	6.00	75	105	25		30
		6.00	75.00	75	105	25		26
1100	-H12	0.40	0.50	95	130	75		3
		0.50	0.80	95	130	75		4
		0.80	1.30	95	130	75		6
		1.30	3.00	95	130	75		8
		3.00	6.00	95	130	75		9
		6.00	12.00	95	130	75		9
12.00	50.00	95	130	75		10		
1100	-H14	0.25	0.30	110	145			1
		0.30	0.50	110	145	95		2
		0.50	0.80	110	145	95		3
		0.80	1.30	110	145	95		4
		1.30	3.00	110	145	95		5
		3.00	6.00	110	145	95		6
		6.00	12.00	110	145	95		6
		12.00	25.00	110	145	95		8

ALLOY	TEMPER	Thickness (mm)		Tensile Strength (MPa)				Elongation (% min in 50mm or 5.65 √A)
		Over	Up to	Ultimate		Yeild		
				Min	Max	Min	Max	
1100	-H16	0.15	0.50	130	165	115		1
		0.50	0.80	130	165	115		2
		0.80	1.30	130	165	115		3
		1.30	4.00	130	165	115		4
1100	-H18	0.15	0.50	150				1
		0.50	0.80	150				2
		0.80	1.30	150				3
		1.30	3.25	150				4
1100	-H112	6.00	12.00	90		50		9
		12.00	50.00	85		35		13
		50.00	75.00	80		30		18
1200	-O	0.15	0.50		105	25		15
		0.50	0.80		105	25		20
		0.80	1.30		105	25		25
		1.30	6.00		105	25		30
		6.00	75.00	75	105	25		26
1200	-H12	0.40	0.50	95	130	75		3
		0.50	0.80	95	130	75		4
		0.80	1.30	95	130	75		6
		3.00	1.30	95	130	75		8
		6.00	3.00	95	130	75		9
		12.00	6.00	95	130	75		9
		50.00	12.00	95	130	75		10
1200	-H14	0.25	0.30	110	145			1
		0.30	0.50	110	145	95		2
		0.50	0.80	110	145	95		3
		0.80	1.30	110	145	95		4
		3.00	3.00	110	145	95		5
		6.00	6.00	110	145	95		6
		12.00	12.00	110	145	95		6
		25.00	25.00	110	145	95		8
1200	-H16	15.00	0.50	130	165	115		1
		0.50	0.80	130	165	115		2
		0.80	1.30	130	165	115		3
		1.30	4.00	130	165	115		4
1200	-H18	0.15	0.50	150				1
		0.50	0.80	150				2
		0.80	1.30	150				3
		1.30	3.25	150				4
1200	-H112	6.00	12.00	90		50		9
		12.00	50.00	85		35		12
		50.00	75.00	80		30		18
3003	-O	0.15	0.20	95	130			14
		0.20	0.30	95	130			18
		0.30	0.80	95	130	35		20
		0.80	1.30	95	130	35		23
		1.30	6.00	95	130	35		25
		6.00	75.00	95	130	35		21

ALLOY	TEMPER	Thickness (mm)		Tensile Strength (MPa)				Elongation (% min in 50mm or 5.65 √A)
		Over	Up to	Ultimate		Yeild		
				Min	Max	Min	Max	
3003	-H12	0.40	0.50	115	160	80		3
		0.50	0.80	115	160	80		4
		0.80	1.30	115	160	80		5
		1.30	3.00	115	160	80		6
		3.00	4.00	115	160	80		7
		4.00	6.00	115	160	80		8
		6.00	12.00	115	160	80		9
		12.00	50.00	115	160	80		8
3003	-H14	0.25	0.30	135	180	115		1
		0.30	0.50	135	180	115		2
		0.50	0.80	135	180	115		3
		0.80	1.30	135	180	115		4
		1.30	3.00	135	180	115		5
		3.00	4.00	135	180	115		6
		4.00	6.00	135	180	115		7
		6.00	12.00	135	180	115		8
12.00	25.00	135	180	115		8		
3003	-H16	0.15	0.50	165	205	145		1
		0.50	0.80	165	205	145		2
		0.80	1.30	165	205	145		3
		1.30	4.00	165	205	145		4
3003	-H18	0.15	0.50	185		165		1
		0.50	0.80	185		165		2
		0.80	1.30	185		165		3
		1.30	3.25	185		165		4
3003	-H112	6.00	12.00	115		70		8
		12.00	50.00	105		40		10
		50.00	75.00	100		40		16
5005	-O	0.15	0.20	105	145			12
		0.20	0.30	105	145			14
		0.30	0.50	105	145	35		16
		0.50	0.80	105	145	35		18
		0.80	1.30	105	145	35		20
		1.30	3.00	105	145	35		21
		3.00	6.00	105	145	35		22
5005	-H12	0.40	0.50	125	165	95		2
		0.50	0.80	125	165	95		3
		0.80	1.30	125	165	95		4
		1.30	3.00	125	165	95		6
		3.00	4.00	125	165	95		7
		4.00	6.00	125	165	95		8
5005	-H14	0.25	0.80	145	185	115		1
		0.80	1.30	145	185	115		2
		1.30	3.00	145	185	115		3
		3.00	4.00	145	185	115		5
		4.00	6.00	145	185	115		6

ALLOY	TEMPER	Thickness (mm)		Tensile Strength (MPa)				Elongation (% min in 50mm or 5.65 √A)
		Over	Up to	Ultimate		Yeild		
				Min	Max	Min	Max	
5005	-H16	0.15	0.80	165	205	135		1
		0.80	1.30	165	205	135		2
		1.30	4.00	165	205	135		3
5005	-H18	0.15	0.80	185				1
		0.80	1.30	185				2
		1.30	3.25	185				3
5005	-H19	0.15	1.00	195				1
5005	-H32	0.40	0.50	115	160	85		3
		0.50	0.80	115	160	85		4
		0.80	1.30	115	160	85		5
		1.30	3.00	115	160	85		7
		3.00	4.00	115	160	85		8
		4.00	6.00	115	160	85		9
5005	-H34	0.25	0.30	135	180			2
		0.30	0.80	135	180	105		3
		0.80	1.30	135	180	105		4
		1.30	3.00	135	180	105		5
		3.00	4.00	135	180	105		6
		4.00	6.00	135	180	105		7
5005	-H36				180		165	6
5005	-H38	0.15	0.30	180				1
		0.30	0.50	180				2
		0.50	0.80	180				3
		0.80	3.25	180				4
5005	-O	0.15	0.20	170	215			-
		0.20	0.30	170	215			14
		0.30	0.50	170	215	65		15
		0.50	0.80	170	215	65		16
		0.80	1.30	170	215	65		18
		1.30	3.00	170	215	65		19
		3.00	6.00	170	215	65		20
		6.00	75.00	170	215	65		16
5052	-H32	0.40	0.50	215	265	160		4
		0.50	1.30	215	265	160		5
		1.30	3.00	215	265	160		7
		3.00	6.00	215	265	160		9
		6.00	12.00	215	265	160		11
		12.00	50.00	215	265	160		10
5052	-H34	0.25	0.50	235	285	180		3
		0.50	1.30	235	285	180		4
		1.30	3.00	235	285	180		6
		3.00	6.00	235	285	180		7
		6.00	25.00	235	285	180		8
5052	-H36	0.15	0.20	255	305			2
		0.20	0.80	255	305	200		3
		0.80	4.00	255	305	200		4

ALLOY	TEMPER	Thickness (mm)		Tensile Strength (MPa)				Elongation (% min in 50mm or 5.65 √A)
		Over	Up to	Ultimate		Yeild		
				Min	Max	Min	Max	
5052	-H38	0.15	0.20	270				2
		0.20	0.80	270		220		3
		0.80	3.25	270		220		4
5052	-H391	0.15	2.00	290		240		3
5052	-H112	6.00	12.00	195		110		7
		12.00	50.00	170		65		10
		50.00	75.00	170		65		14
5251	Mechanical properties are almost identical to 5052							
5454	-O	0.50	0.80	215	285	80		12
		0.80	1.30	215	285	80		14
		1.30	3.00	215	285	80		16
		3.00	75.00	215	285	80		16
5454	-H32	0.50	1.30	250	305	180		5
		1.30	6.00	250	305	180		8
		6.00	50.00	250	305	180		10
5454	-H34	0.50	1.30	270	325	200		4
		1.30	4.00	270	325	200		6
		4.00	6.00	270	325	200		7
		6.00	25.00	270	325	200		8
5454	-H112	6.00	12.00	220		125		8
		12.00	50.00	215		80		9
		50.00	75.00	215		80		13
5083	-O	1.30	40.00	275	350	125	200	14
		40.00	75.00	270	345	115	200	14
5083	-H111	6.00	40.00	290	350	170	285	12
5083	-H121	6.00	50.00	305	385	215	295	10
5083	-H311	6.00	40.00	290	350	170	285	14
5083	-H321	5.00	40.00	305	385	215	295	10
		40.00	75.00	280	385	200	295	10
5083	-H323	1.30	3.20	310	375	235	305	8
		3.20	6.00	310	375	235	305	10
5083	-H343	1.30	3.20	345	405	270	340	6
		3.20	6.00	345	405	270	340	8
5083	-H112	6.00	40.00	275		125		10
		40.00	75.00	270		115		10
5083	-H115	20.00	50.00	310		255		7
		50.00	70.00	305		240		7
5083	-H116	3.00	6.00	305		215		10
		6.00	30.00	305		215		10
6061	-O	0.25	0.50	150		85		14
		0.50	3.25	150		85		16
		3.25	12.00	150		85		18
		12.00	25.00	150				16
6061	-T4	0.25	0.50	205		115		14
		0.50	6.00	205		115		16
		6.00	25.00	205		115		16

ALLOY	TEMPER	Thickness (mm)		Tensile Strength (MPa)				Elongation (% min in 50mm or 5.65 √A)
		Over	Up to	Ultimate		Yeild		
				Min	Max	Min	Max	
6061	-T42	0.25	0.50	205		95		14
		0.50	6.00	205		95		16
		6.00	25.00	205		95		16
6061	-T6 & 62	0.25	0.50	290		240		8
		0.50	12.00	290		240		10
		12.00	25.00	290		240		7
7075	-T6 & 62			570		505		11
8011	-O	0.15	0.30	75	105			16
		0.30	0.80	75	105			20
		0.80	1.30	75	105			25
		1.30	5.00	75	105			30
8011	-H12	0.20	0.50	100	135			3
		0.50	0.80	100	135			4
		0.80	1.30	100	135			6
		1.30	3.00	100	135			8
		3.00	6.00	100	135			9
8011	-H14	0.20	0.50	115	150			2
		0.50	0.80	115	150			3
		0.80	1.30	115	150			4
		1.30	3.00	115	150			5
		3.00	6.00	115	150			7
8011	-H16	0.20	0.50	140	170			1
		0.50	0.80	140	170			2
		0.80	1.30	140	170			3
		1.30	3.00	140	170			4
		3.00	6.00	140	170			5
8011	-H18	0.20	0.50	160				1
		0.50	0.80	160				2
		0.80	1.30	160				3
		1.30	3.00	160				4

*Elevate Your Designs
with Our Aluminum Excellence*



*Crafted with **meticulous precision**
Our Aluminum Extrusions guarantee **seamless performance**
Setting a new standard in **quality & reliability** for your diverse applications*



SD
ALUMINIUM

Contact Us Now!



Auckland Rosedale Branch

Address: 6 John Glenn Ave, Rosedale, Auckland 0632

Phone: 09-218 2188, 09-218 2111

Email: info@sdaluminium.co.nz

Auckland Manukau Branch

Address: 28 Ryan Place, Manukau City, Auckland 2104

Phone: 09-217 8666

Email: info@sdaluminium.co.nz

 <https://www.linkedin.com/company/67363257/admin/feed/posts/>

 <https://www.linkedin.com/company/67363257/admin/feed/posts/>

 <https://www.facebook.com/SDAluminiumLtd>

Follow Us on Social Media