



Aluminium Louvre Systems

Cladding Louvres | Sliding Louvres | Interior Separations | Blinds and Roofs | Window Shrouds

Enhance the aesthetics and
functionality of your property

May 2024 Edition

www.sdalu.co.nz

Cladding Louvres & Window Shroud Systems

Aesthetic Appeal:

Aluminium cladding louvres offer a sleek and modern look that can enhance the aesthetic appeal of a building. They can be used to create a unique and eye-catching design feature.

Durability:

Aluminium is a highly durable material that is resistant to corrosion, rust, and other forms of damage. This makes it an ideal choice for louvres that are exposed to the elements.

Low Maintenance:

Aluminium cladding louvres require very little maintenance, as they are resistant to corrosion and weathering. This makes them a cost-effective solution in the long run.



Sliding Louvres Systems

Aesthetic Appeal:

Our Sliding louvres come in a range of styles and finishes, making it easy to find an option that complements your home's architecture and design.

Durability:

Aluminium is a highly durable material that is resistant to corrosion, rust, and other forms of damage. This makes it an ideal choice for louvres that are exposed to the elements.

Ventilation:

Our sliding louvre screens are also a great option for ventilation, as they allow for precise control over the amount of air flow that enters your home or commercial space. By adjusting the angle of the louvers, you can regulate the amount of air that flows through the screen.



Louvre Roofs & Blinds

Aesthetic Appeal:

Our Sliding louvres come in a range of styles and finishes, making it easy to find an option that complements your home's architecture and design.

Sun & Shade:

A louvre roof allows you to adjust the amount of sunlight and shade that enters your deck area, giving you complete control over your outdoor living space.

More Living Space:

Louvre roofs provide a versatile and functional outdoor living space that can be used for a variety of activities. They also allow you to extend your living space outdoors, giving you more room to spread out and enjoy the fresh air.



Internal Separation

Functionality:

Our Separation Louvres can help to divide a space into different functional areas. This can help to create a more efficient and organized space, and make it easier to use for different activities.

Privacy & Safety:

Internal separation can provide a greater degree of privacy within a space, particularly in open-plan areas where there are no walls. Also offering a protect

Aesthetics:

Internal separation can also be used to enhance the aesthetic appeal of a space, by adding visual interest and variety. it can help to create a more dynamic and visually engaging environment.

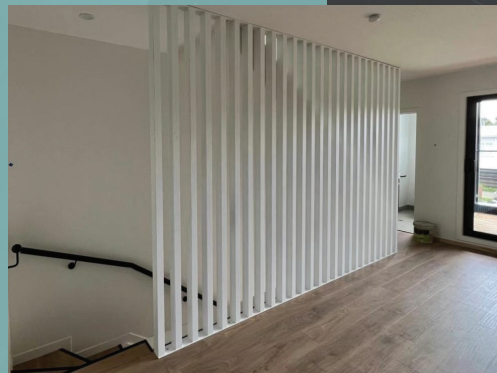
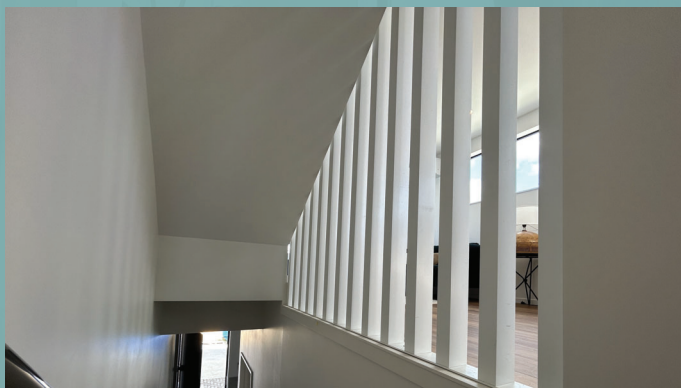

Slim Rectangular Blade

Cross Section Drawing

Full Bullnose Edge

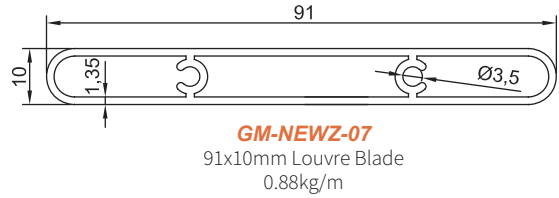
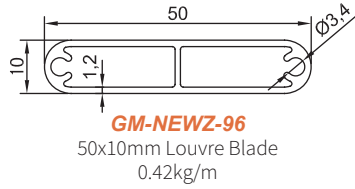
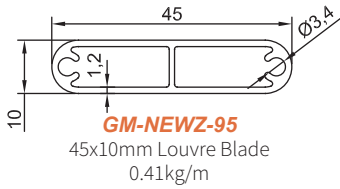

Slim Rectangular Blade

Cross Section Drawing

Standard Edge

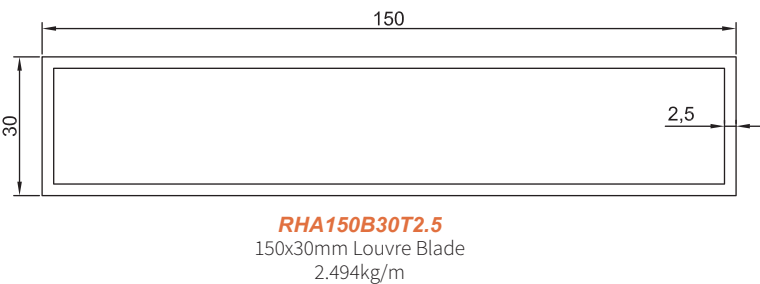
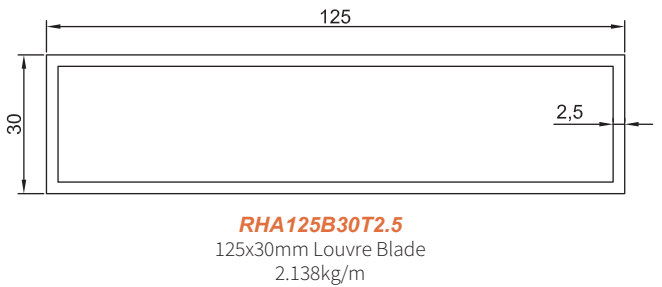
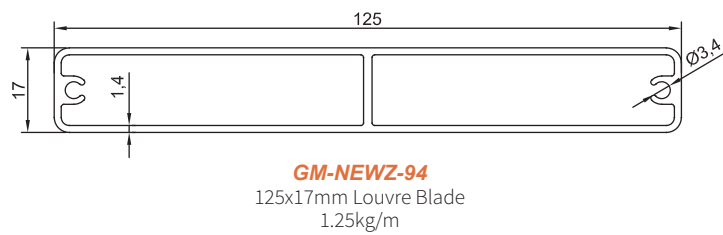
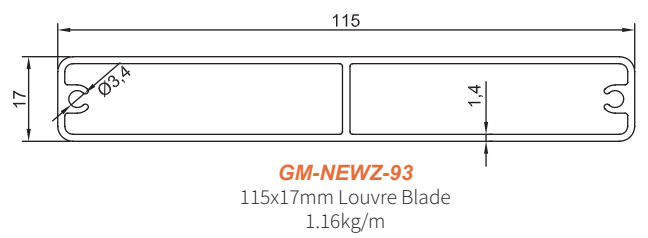
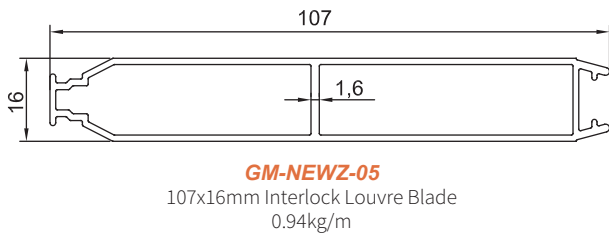
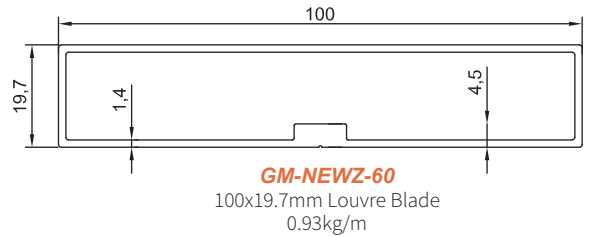
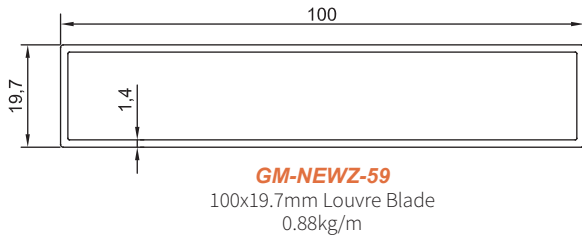
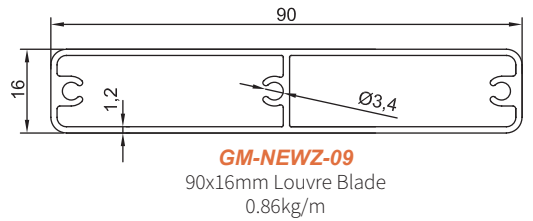
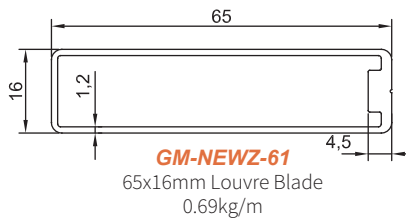
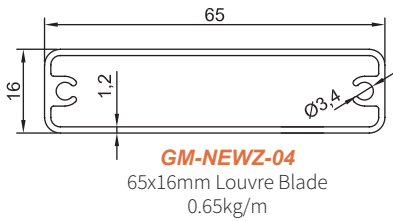

Fusiform Blade

Cross Section Drawing

with End Caps and Holders

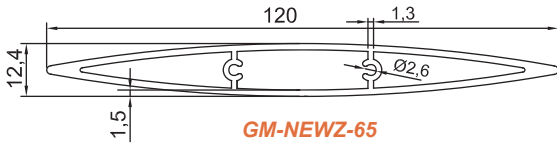

GM-NEWZ-65
120x12.4mm Louvre Blade
1.17kg/m

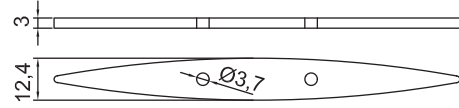

SL-183
GM-NEWZ-65 End Cap

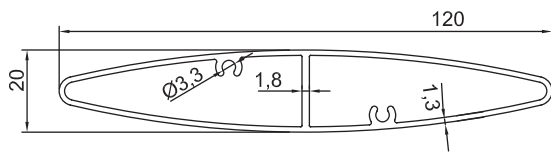

GM-NEWZ-06
120x20mm Louvre Blade
1.09kg/m

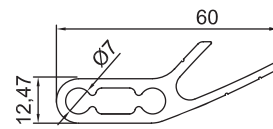

GM-NEWZ-06

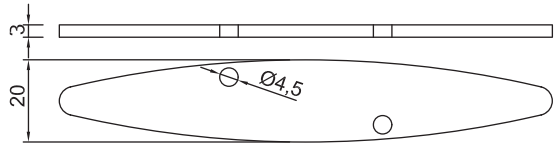

SL-82
GM-NEWZ-06 End Cap

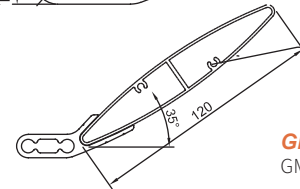

GM-NEWZ-71
GM-NEWZ-06 Holder

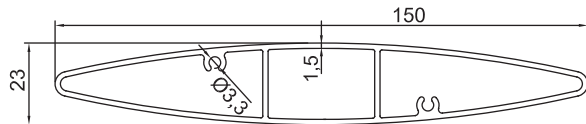

GM-NEWZ-70
150x23mm Louvre Blade
1.58kg/m

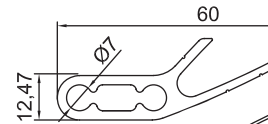

GM-NEWZ-70

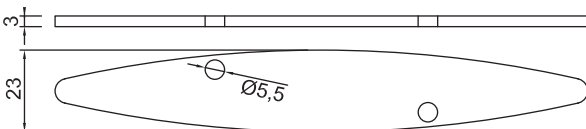

SL-182
GM-NEWZ-70 End Cap

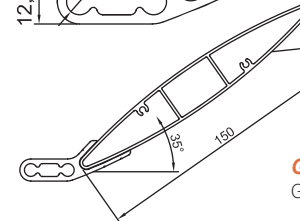

GM-NEWZ-71
GM-NEWZ-70 Holder

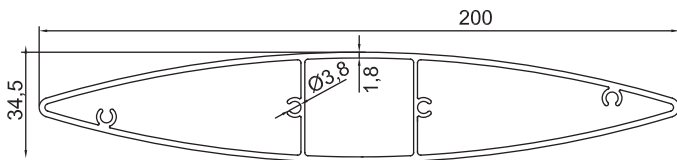

GM-NEWZ-102
200x34.5mm Louvre Blade
2.45kg/m

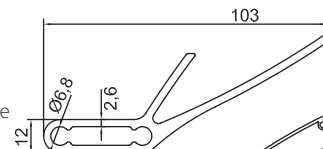

GM-NEWZ-102

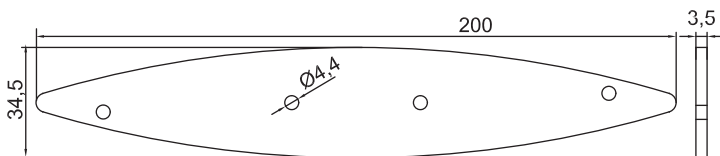

SL-165
GM-NEWZ-102 End Cap

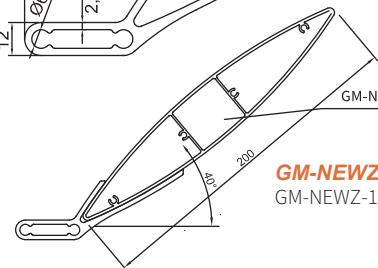

GM-NEWZ-130
GM-NEWZ-102 Holder

Quadrilateral Blade

Cross Section Drawing

with End Caps and Holders

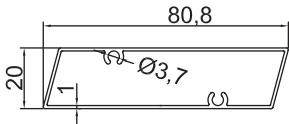

GM-NEWZ-142
80.8x20mm Louvre Blade
0.61kg/m

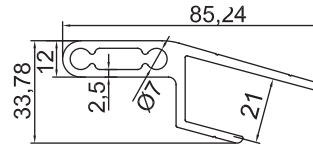

GM-NEWZ-144
GM-NEWZ-142 & 143 Holder

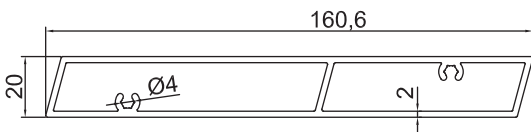

GM-NEWZ-143
160.6x20mm Louvre Blade
2.21kg/m



SL-179
GM-NEWZ-143 End Cap

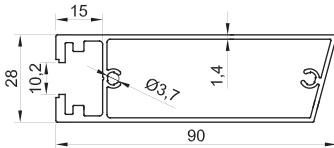
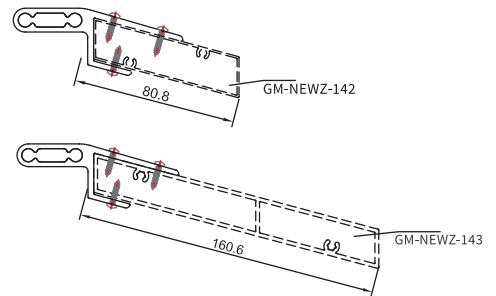

GM-NEWZ-181
100x30mm Louvre Blade
1.210kg/m

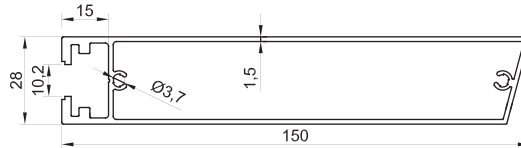

GM-NEWZ-182
150x30mm Louvre Blade
1.770kg/m

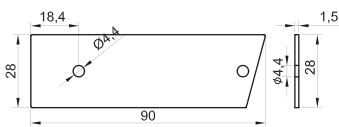

GM-NEWZ-181 End Cap
0.011kg/m

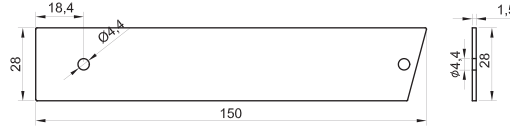

GM-NEWZ-182 End Cap
0.018kg/m

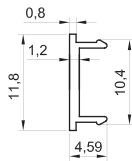

GM-NEWZ-183
181 / 182 Side Cap
0.05kg/m

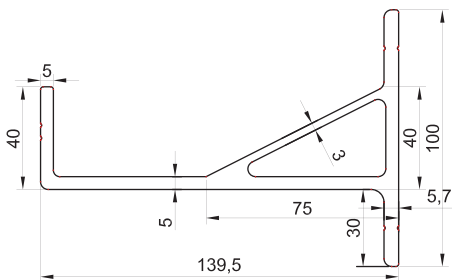
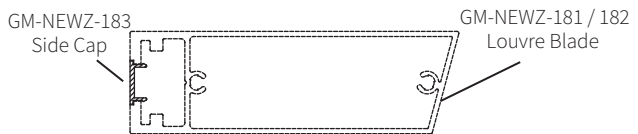

GM-NEWZ-184
Louvre Blade Holder
4.690kg/m

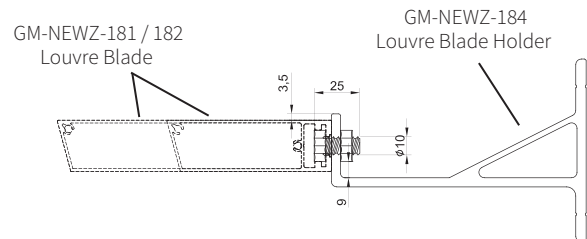

Standard Rectangulare Blade

Cross Section Drawing

with End Caps and Holders

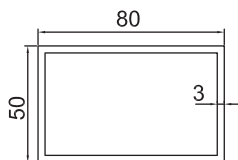
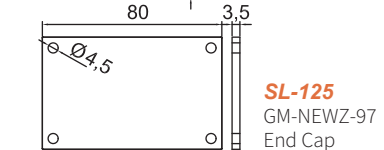
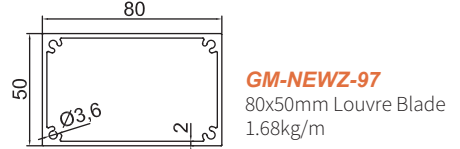

RHA80B50T3
80x50mm Louvre Blade
2.120kg/m

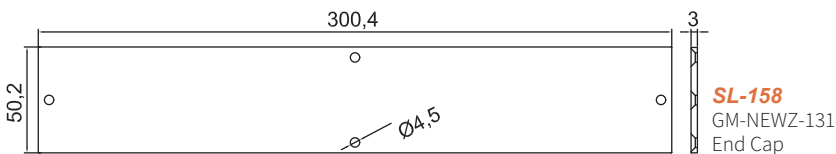
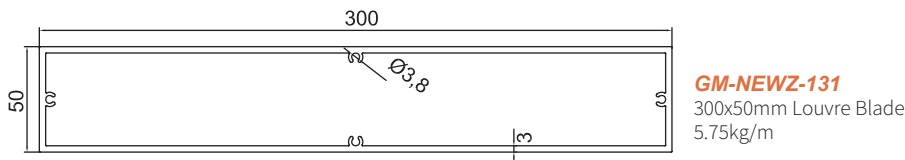
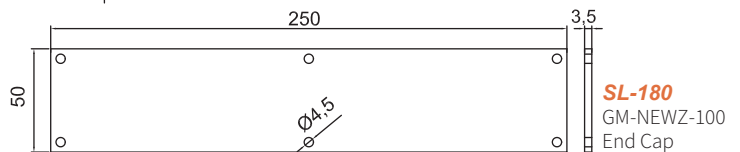
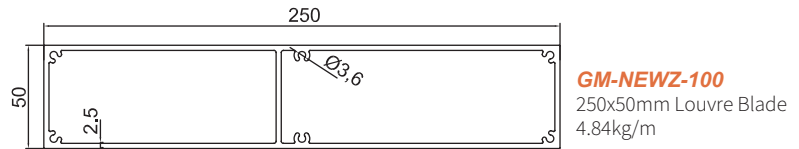
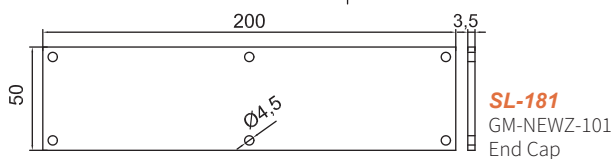
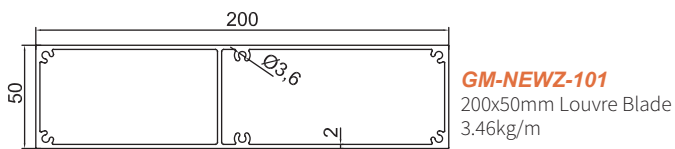
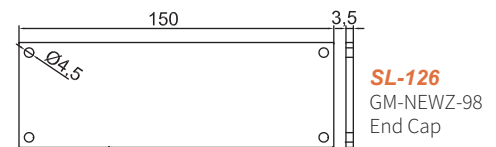
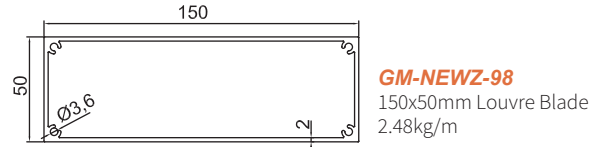
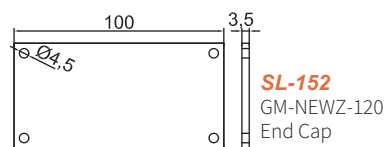
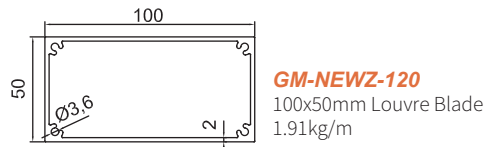

Clip-on Rectangular Blade

Cross Section Drawing

with End Caps and Holders

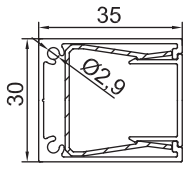

GM-NEWZ-56&57&58
30x35mm Louvre Blade
0.77kg/m

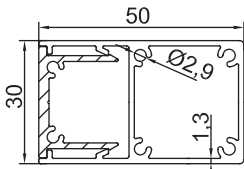

GM-NEWZ-51&53
30x50mm Louvre Blade
1.07kg/m

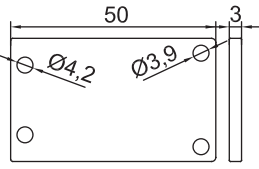

SL-18
GM-NEWZ-51 End Cap

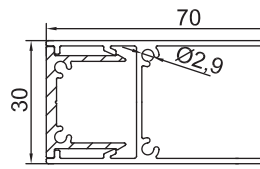

GM-NEWZ-52&53
30x70mm Louvre Blade
1.22kg/m

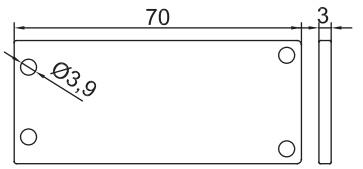

SL-17
GM-NEWZ-52 End Cap

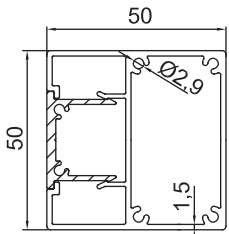

GM-NEWZ-54&53
50x50mm Louvre Blade
1.48kg/m

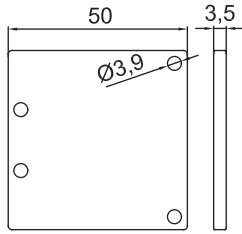

SL-16
GM-NEWZ-54 End Cap

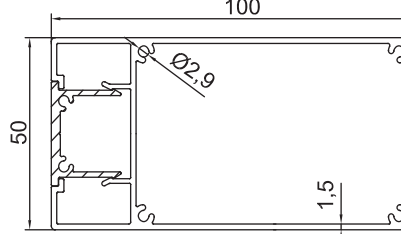

GM-NEWZ-55&53
50x100mm Louvre Blade
1.91kg/m

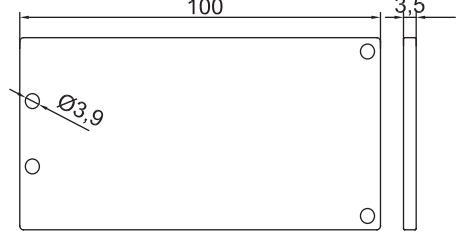

SL-15
GM-NEWZ-55 End Cap

Cross Section Drawing

Sliding Systems

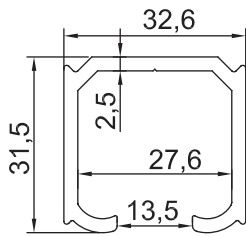

GM-NEWZ-135
Roller Sliding Track
0.72kg/m

Sliding Track

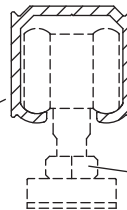

Roller



SL-190
Sliding Louvre Roller

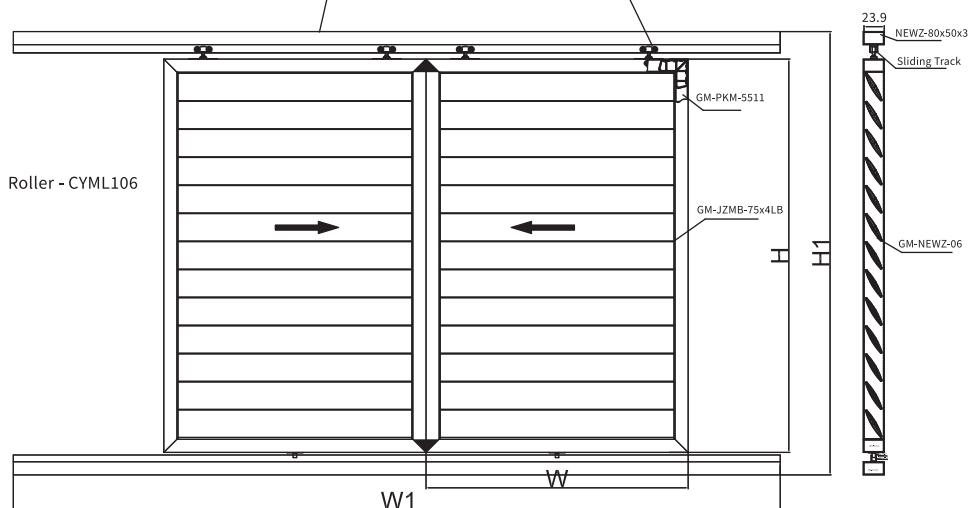



Flat Window Shroud

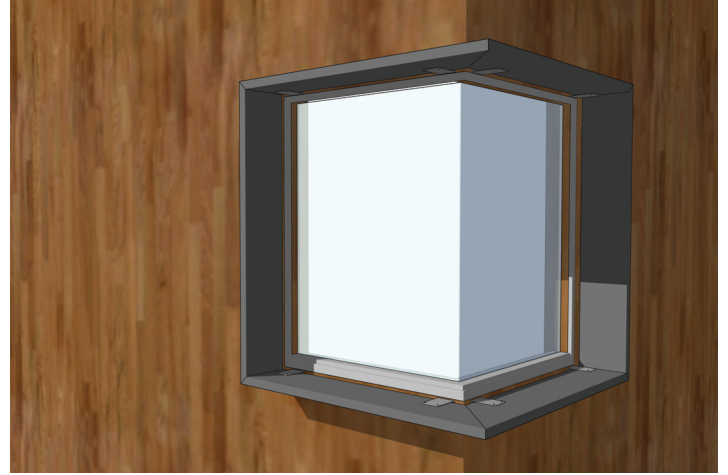

Corner Window Shroud

Window Shroud Profiles

Cross Section Drawing

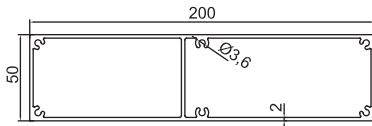

200mm Window Shroud

GM-NEWZ-101

200x50mm Louvre Blade
3.46kg/m

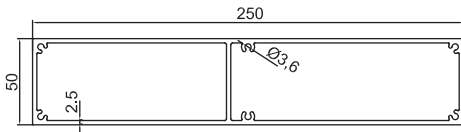

250mm Window Shroud

GM-NEWZ-100

250x50mm Louvre Blade
4.84kg/m

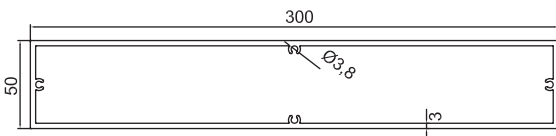

300mm Window Shroud

GM-NEWZ-131

300x50mm Louvre Blade
5.75kg/m

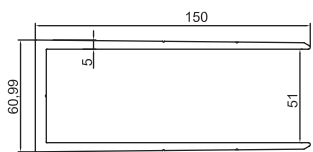

Window Shroud Holder

GM-NEWZ-145

50mm Louvre Blade Holder
300mm long

Window Shroud Holder

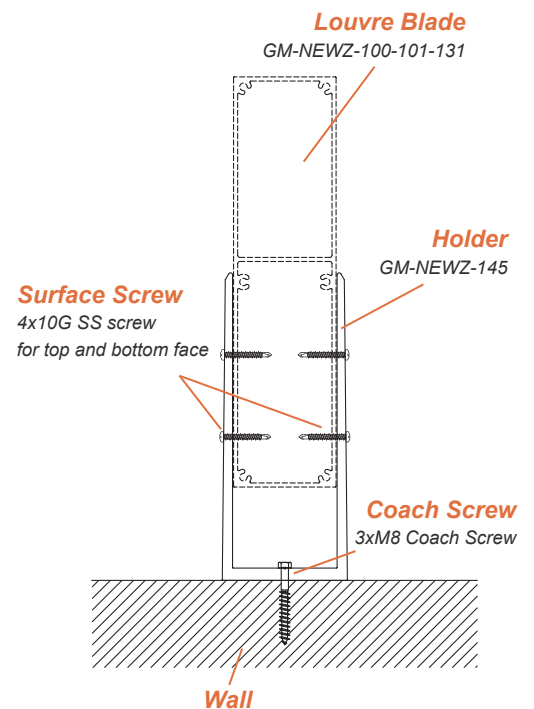
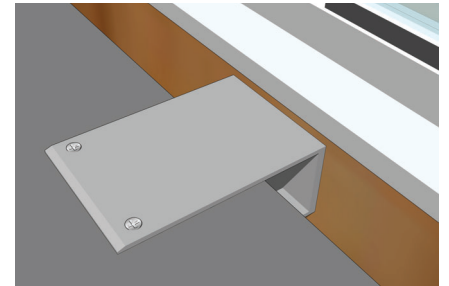

Cross Section Drawing

Corner Stakes

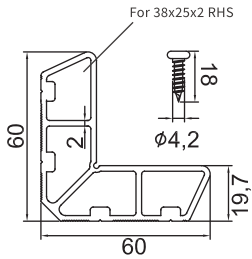

GM-NEWZ-121
38x25mm Corner Stake

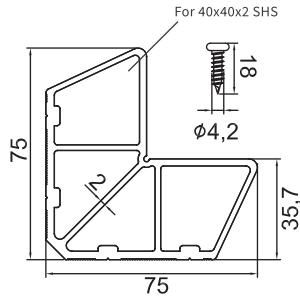

GM-NEWZ-122
40x40mm Corner Stake

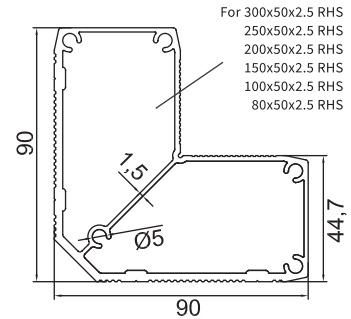

GM-NEWZ-134
50mm Corner Stake

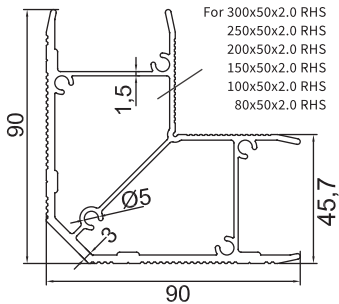

GM-NEWZ-133
50mm Corner Stake

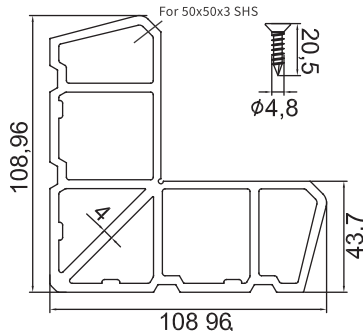

GM-KPM-5511
50x50mm Corner Stake

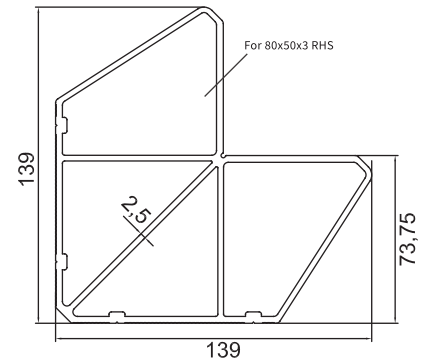

GM-KPM-123
80x50mm Corner Stake

Cross Section Drawing

Blade Holders

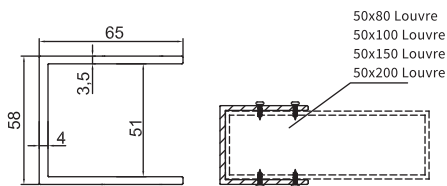

GM-NEWZ-58x65x3.5U
50mm Louvre Blade Holder

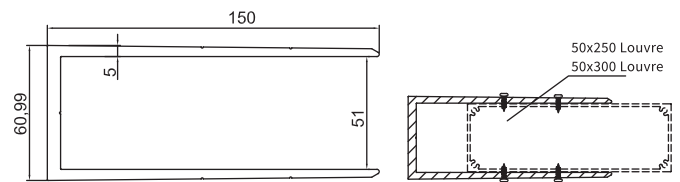

GM-NEWZ-145
50mm Louvre Blade Holder

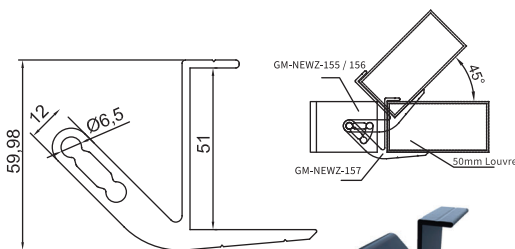

GM-NEWZ-157
50mm Louvre Blade Holder

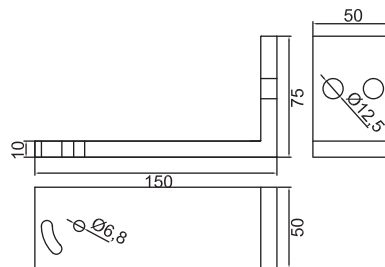

SL-155
GM-NEWZ-157 150mm Stand

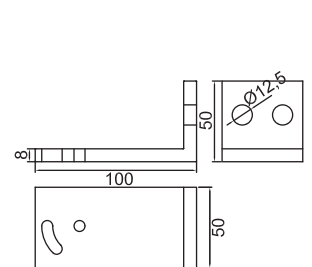

SL-156
GM-NEWZ-157 100mm Stand

Powder Coat

Our powder coating aluminum provides an attractive, durable, and cost-effective solution that is environmentally friendly and customizable to suit a wide range of design needs.

Durability: Powder coated aluminum is extremely durable and can withstand harsh weather conditions, including extreme heat, cold, and humidity. The powder coating also provides protection against scratches, chipping, and fading, which makes it an ideal choice for outdoor applications.

Aesthetics: It provides a smooth, even finish that is available in a wide range of colors and textures. This allows for customization and flexibility in design choices, making it an attractive option for architectural, automotive, and consumer applications.

Environmental Sustainability: Powder coating is an environmentally friendly alternative to liquid paint. It produces very little waste, and the overspray can be collected and reused, reducing waste and saving on material costs. Additionally, powder coating does not emit any volatile organic compounds (VOCs) into the air, making it a safer option for the environment.

Stocked Colours



Matt Black



Matt Ironsand

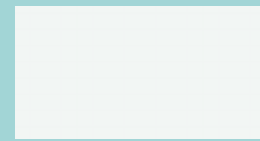

*Matt
Appliance White*



*Dark Cedar
Wood-grain*

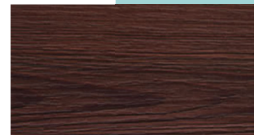

*Antique Wood
Wood-grain*

Other colour can be customised



Contact Us Now!



Auckland Rosedale Branch

Address: 6 John Glenn Ave, Rosedale, Auckland 0632

Phone: 09-218 2188, 09-218 2111

Email: info@sdaluminium.co.nz

Auckland Manukau Branch

Address: 28 Ryan Place, Manukau City, Auckland 2104

Phone: 09-217 8666

Email: info@sdaluminium.co.nz



<https://www.linkedin.com/company/67363257/admin/feed/posts/>



<https://www.linkedin.com/company/67363257/admin/feed/posts/>



<https://www.facebook.com/SDAluminiumLtd>

Follow Us on Social Media