

Pre-Punched Extrusions

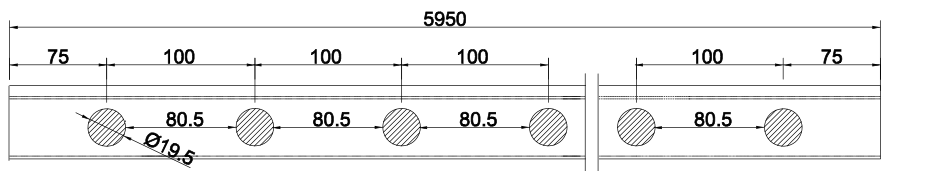

Pre-Punched Extrusions

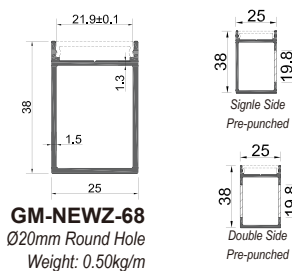
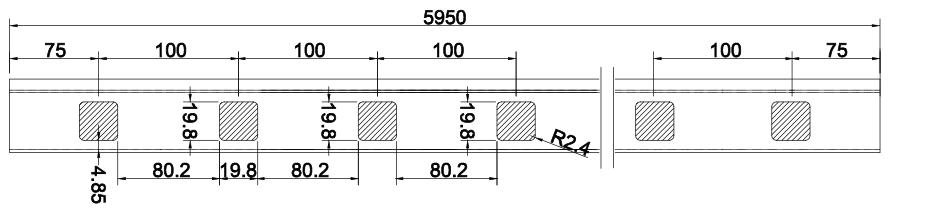
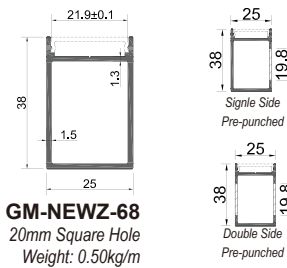
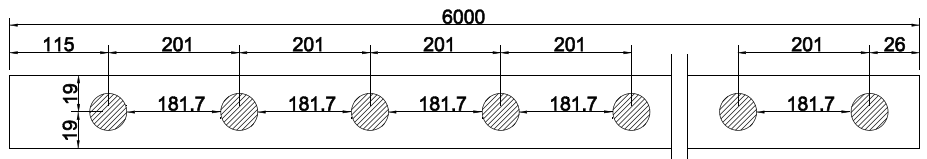
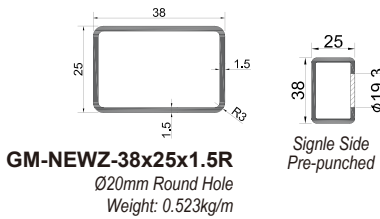
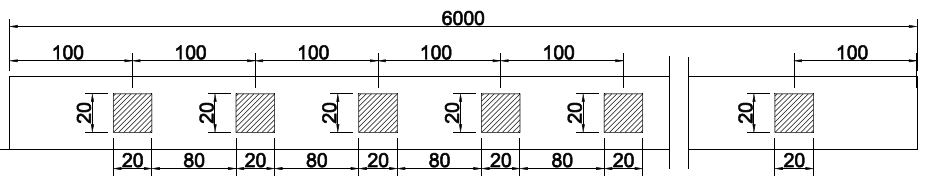
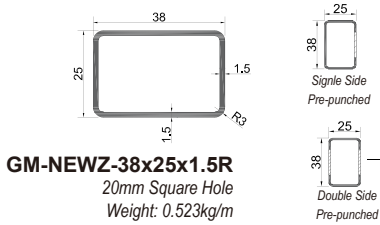
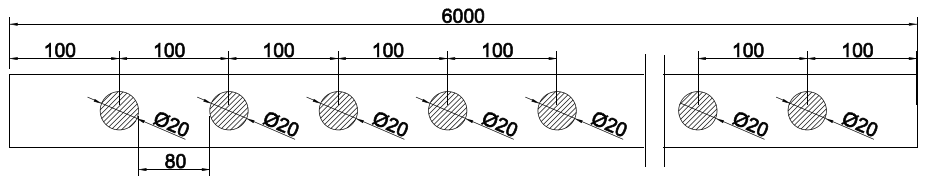
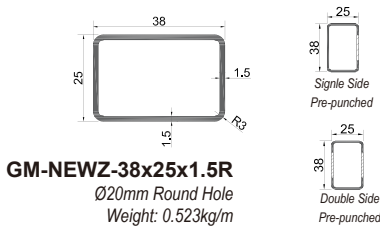
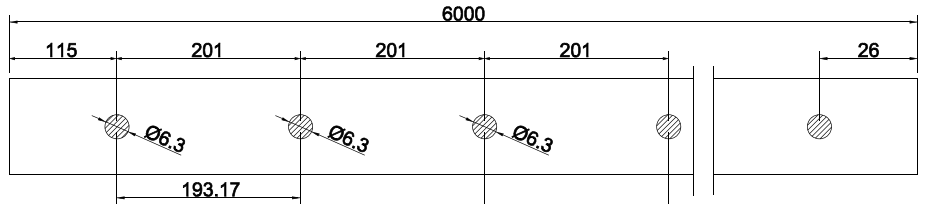
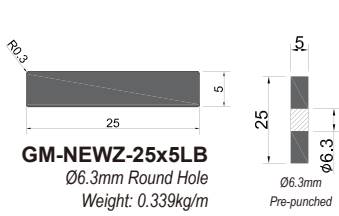
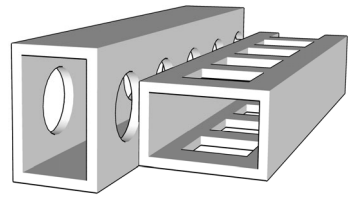
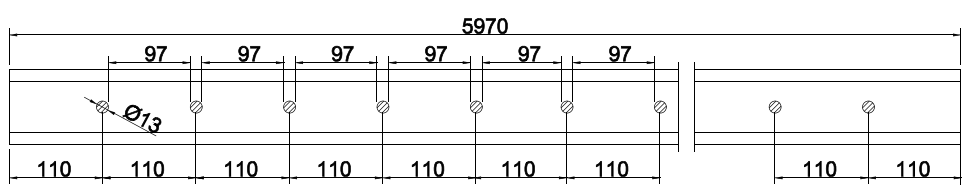
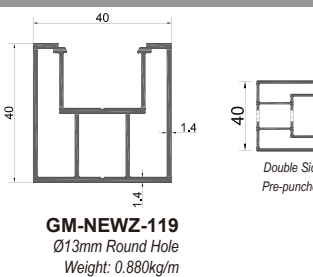
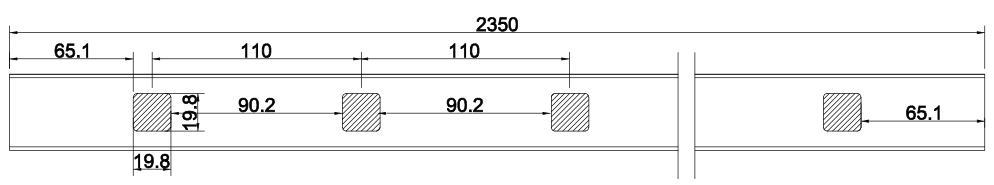
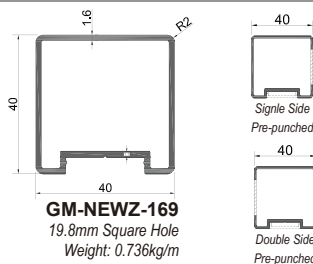
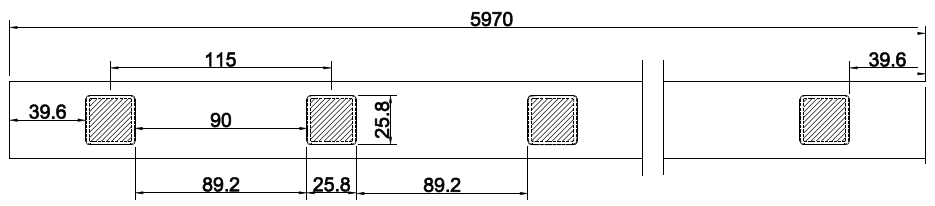
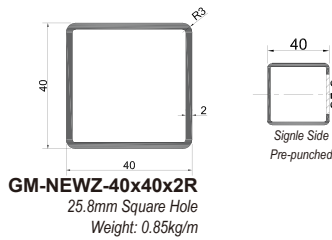
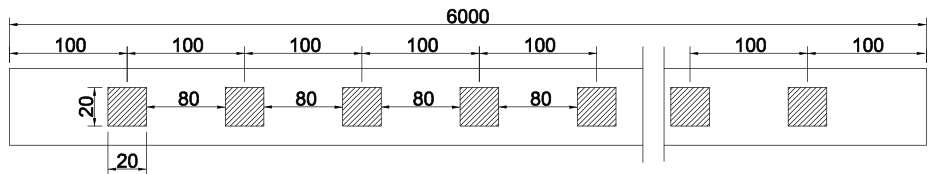
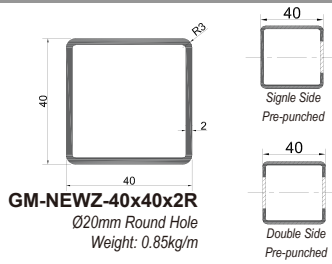
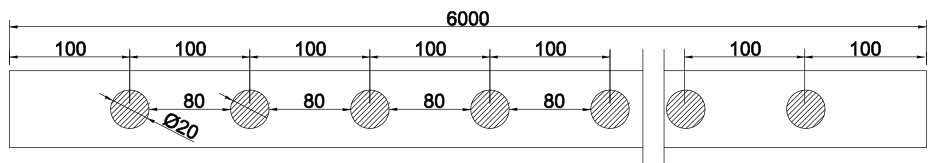
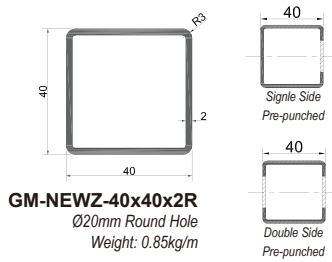
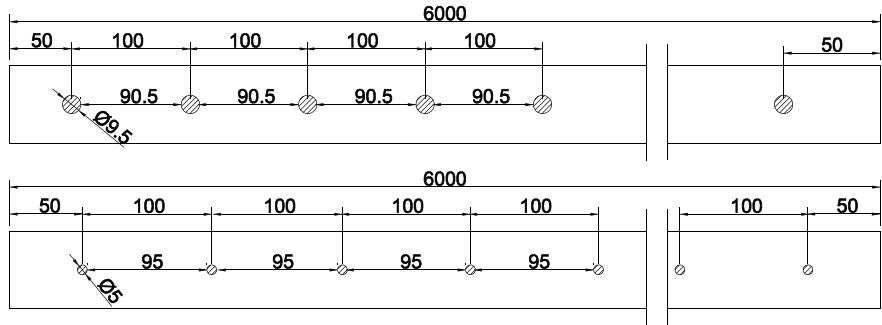
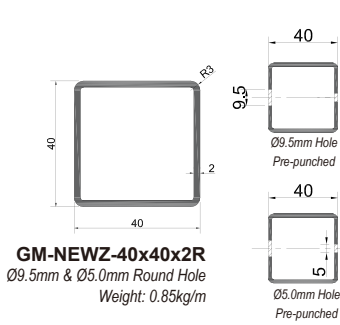
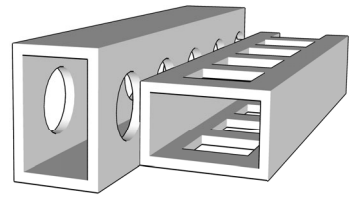

Pre-Punched Extrusions

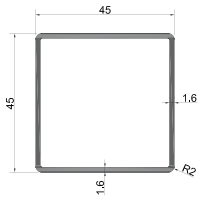
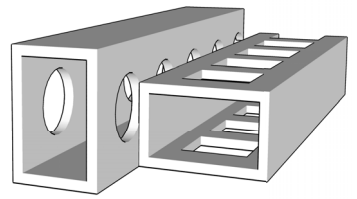

GM-NEWZ-45x45x1.6R
25.6mm Square Hole
Weight: 0.783kg/m

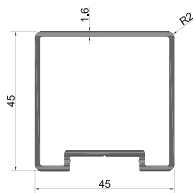
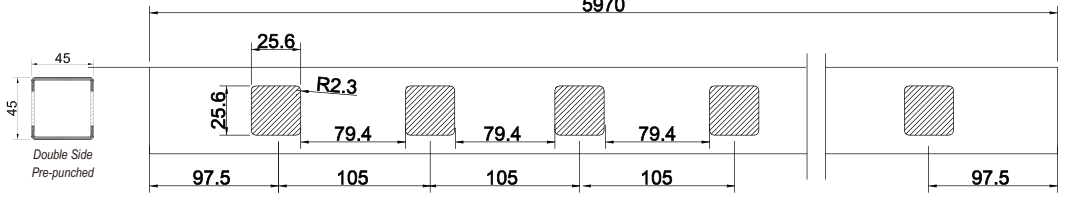

GM-NEWZ-167
25.8mm Square Hole
Weight: 0.830kg/m

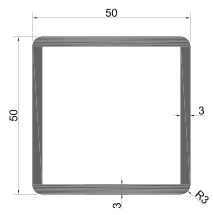
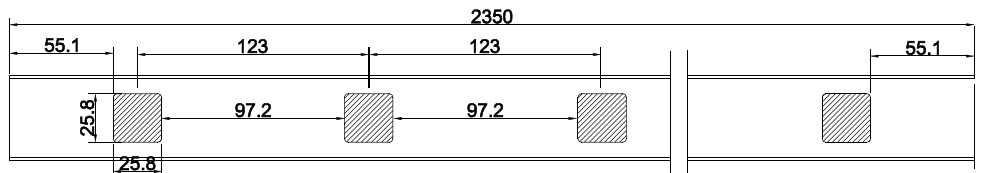
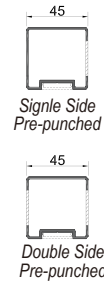

GM-NEWZ-50x50x3R
Ø20mm Round Hole
Weight: 1.67kg/m

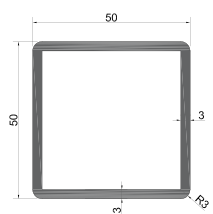
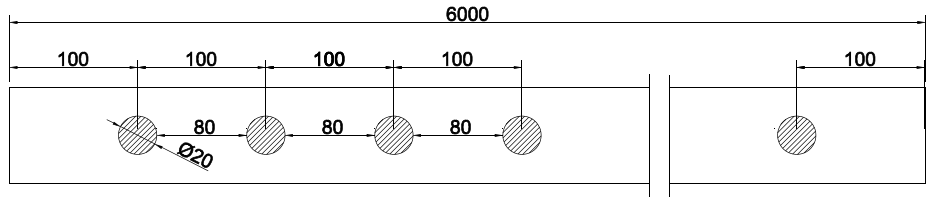
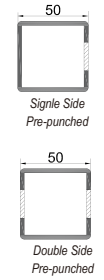

GM-NEWZ-50x50x3R
20mm Square Hole
Weight: 1.67kg/m

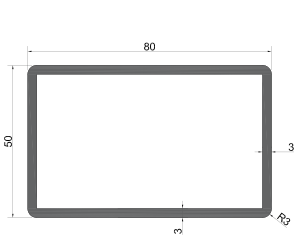
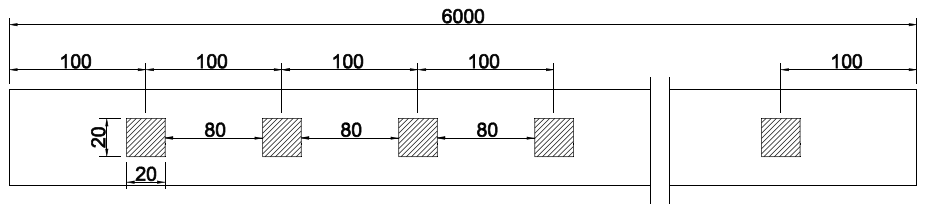
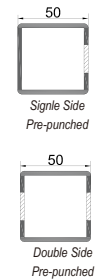

WZ-80x50x3R
Ø20mm Round Hole
Weight: 2.21kg/m

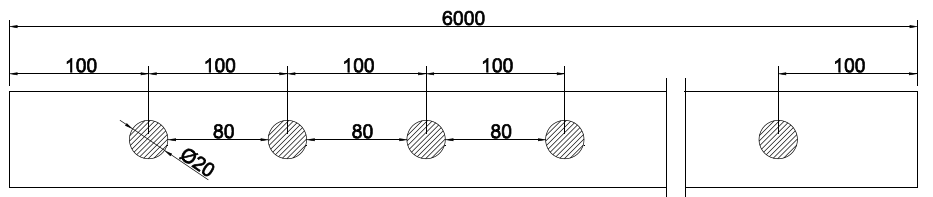
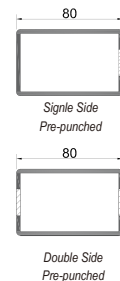

Pre-Punched Extrusions

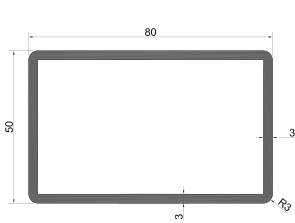
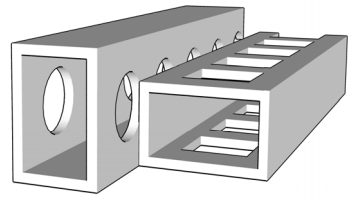

WZ-80x50x3R
20mm Square Hole
Weight: 2.21kg/m

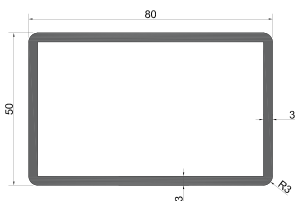
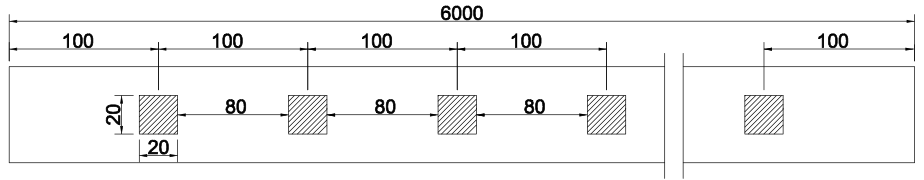
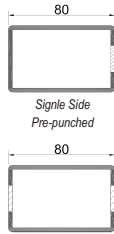

WZ-80x50x3R
25.8mm Square Hole
Weight: 2.21kg/m

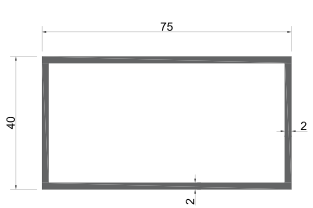
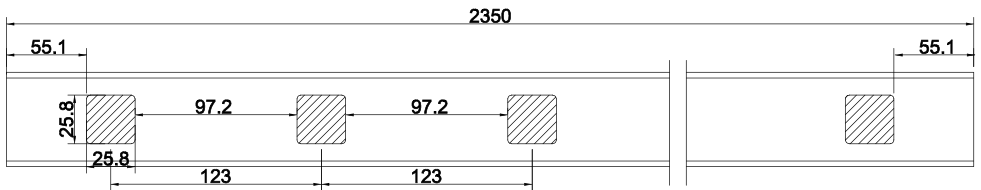
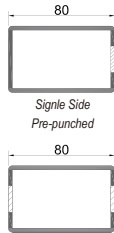

GM-NEWZ-75x40x2
GM-NEWZ-06 Hole
Weight: 1.33kg/m

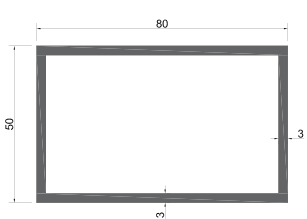
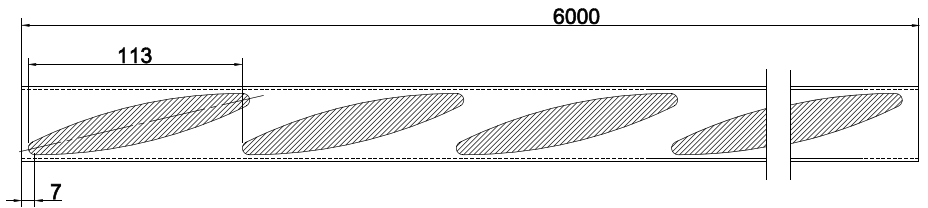
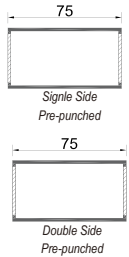

GM-NEWZ-80x50x3
GM-NEWZ-06 Hole
Weight: 2.33kg/m

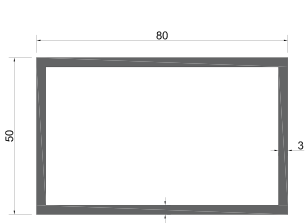
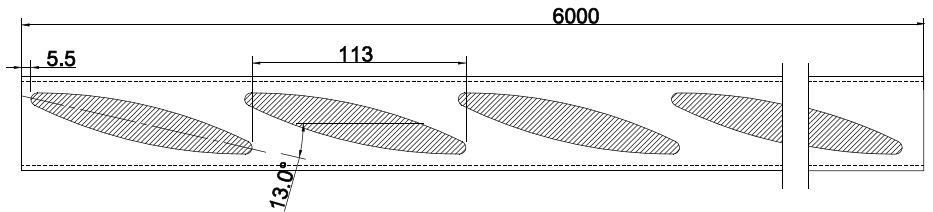
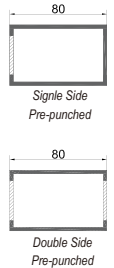

GM-NEWZ-80x50x3
GM-NEWZ-06 Hole
Weight: 2.33kg/m

