

"✓" Stocked Item  
 "✱" Pre-order Only Item  
 (30-40 working days delivery)

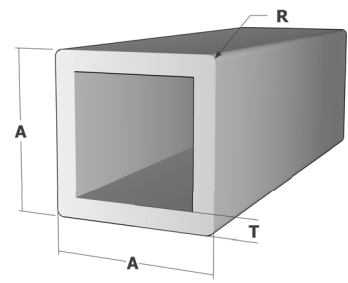

# Square Hollow



Product Code	Ex Stock	A (mm)	T (mm)	R (mm)	Mass (kg/m)	Perimeter (mm)	Area (mm <sup>2</sup> )
SHA10T1	✱	10.0	1.0		0.103	40.00	36.00
SHA12T1	✓	12.0	1.0		0.125	48.00	44.00
SHA15T1	✱	15.0	1.0		0.160	60.00	56.00
SHRA15T1R1.5	✱	15.0	1.0	1.5	0.150	55.83	52.49
SHA15T1.2	✱	15.0	1.2		0.189	60.00	66.24
SHA15T1.5	✓	15.0	1.5		0.231	60.00	81.14
SHA16T1.3	✓	16.0	1.3		0.218	64.00	76.44
SHRA16T1.8R2.8	✱	16.0	1.8	2.8	0.314	58.85	110.00
SHA18T1.2	✱	18.0	1.2		0.230	72.00	80.64
SHA18T2.2	✓	18.0	2.2		0.396	72.00	139.00
SHRA18.7T1.3R6	✱	18.7	1.3	6.0	0.224	64.50	78.54
SHRA18.8T1.35R6	✱	18.8	1.35	6.0	0.233	64.90	81.89
SHA19T0.8	✱	19.0	0.8		0.166	76.00	58.40
SHA19T1	✱	19.0	1.0		0.205	76.00	72.00
SHA19T1.2	✓	19.0	1.2		0.244	76.00	85.44
SHRA19T1.2R2	✓	19.0	1.2	2.0	0.235	72.57	82.56
SHA19T1.6	✓	19.0	1.6		0.317	75.14	113.36
SHRA19T2R2	✓	19.0	2.0	2.0	0.378	72.60	132.64
SHA20T0.55	✱	20.0	0.55		0.122	80.00	42.79
SHA20T0.7	✱	20.0	0.7		0.154	80.00	54.00
SHA20T1.2	✓	20.0	1.2		0.257	80.00	90.24
SHRA20T1.6R2	✱	20.0	1.6	2.0	0.326	76.57	114.46
SHRA20T1.8R2	✱	20.0	1.8	2.0	0.364	76.57	127.70
SHRA20T1.9R1	✱	20.0	1.9	1.0	0.390	78.28	136.80
SHA20T2	✓	20.0	2.0		0.410	80.00	144.00
SHA20T3	✱	20.0	3.0		0.581	80.00	144.00
SHRA21T1.8R2.8	✱	21.0	1.8	2.8	0.418	79.30	146.52
SHA22T0.75	✱	22.0	0.75		0.182	87.00	63.75
SHRA22T1.1	✱	22.0	1.1		0.262	87.50	91.96
SHRA23T2R2.5	✱	23.0	2.0	2.5	0.464	87.70	162.71
SHRA23.8T10.9R1	✱	23.8	10.9	1.0	0.186	6.54	65.40
SHA24.8T1.5	✱	24.8	1.5		0.398	98.69	139.80
SHA24.8T1.8	✱	24.8	1.8		0.472	98.68	58.56
SHA25T0.6	✱	25.0	0.6		0.167	99.49	72.67
SHA25T0.8	✱	25.0	0.8		0.207	99.49	144.00
SHA25T1	✱	25.0	1.0		0.274	99.50	136.80
SHA25T1.2	✓	25.0	1.2		0.326	100.00	114.24
SHRA25T1.2R2	✓	25.0	1.2	2.0	0.317	96.57	111.36
SHA25T1.5	✱	25.0	1.5		0.402	100.00	141.00
SHRA25T1.5R2	✓	25.0	1.5	2.0	0.393	96.60	137.80

"✓" Stocked Item  
 "✱" Pre-order Only Item  
 (30-40 working days delivery)



# Square Hollow

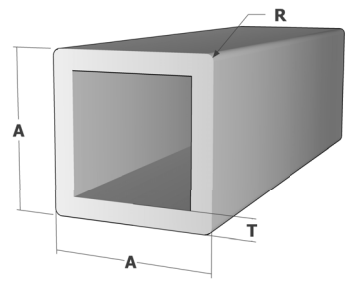

Product Code	Ex Stock	A (mm)	T (mm)	R (mm)	Mass (kg/m)	Perimeter (mm)	Area (mm <sup>2</sup> )
SHRA25T1.8R2	✱	25.0	1.8	2.0	0.463	95.80	162.30
SHA25T2	✓	25.0	2.0		0.524	100.00	184.00
SHRA25T2R2	✱	25.0	2.0	2.0	0.510	95.76	179.00
SHRA25T2R3	✓	25.0	2.0	3.0	0.505	94.85	177.13
SHRA25T2.5R2	✱	25.0	2.5	2.0	0.626	95.76	219.60
SHRA25T3R3	✓	25.0	3.0	3.0	0.731	94.85	256.35
SHA25T3	✓	25.0	3.0		0.752	100.00	264.00
SHA25.4T0.9	✱	25.4	0.9		0.251	101.10	88.20
SHA28T2	✱	28.0	2.0		0.593	111.50	207.92
SHRA28.5T1.8R2.5	✱	28.5	1.8	2.5	0.533	109.70	187.10
SHA29.5T0.65	✱	29.5	0.65		0.214	118.00	75.00
SHA29.5T1.75	✱	29.5	1.75		0.554	119.14	194.25
SHA30T0.8	✱	30.0	1.2		0.299	120.00	104.76
SHRA30T1.5R1.5	✱	30.0	1.5	1.5	0.480	117.42	169.14
SHA30T1.9	✱	30.0	1.9		0.609	119.50	213.56
SHRA30T2R2	✱	30.0	2.0	2.0	0.629	116.57	220.64
SHRA30T2R3	✓	30.0	2.0	3.0	0.619	114.85	217.13
SHA30T3	✱	30.0	3.0		0.923	119.50	324.00
SHA31.8T0.9	✱	31.8	0.9		0.317	126.50	111.10
SHRA32T1.2R3	✓	32.0	1.2	3.0	0.407	122.85	142.90
SHRA32T2.3R3.5	✱	32.0	2.3	3.5	0.759	121.99	266.16
SHRA32T3	✱	32.0	3.0		0.992	128.00	172.23
SHRA32.1T1.45R3	✱	32.1	1.45	3.0	0.491	123.34	172.23
SHRA33T3R5	✱	33.0	3.0	5.0	0.975	123.42	341.97
SHRA34T1.6R3	✓	34.0	1.6	3.0	0.574	130.85	201.32
SHA35T1	✱	35.0	1.0		0.388	140.00	136.00
SHRA35T1.6R1.5	✱	35.0	1.6	1.5	0.605	137.40	212.30
SHA35T1.75	✱	35.0	1.75		0.663	139.14	232.75
SHRA35T2R2	✱	35.0	2.0	2.0	0.743	136.57	260.64
SHRA36T1.5R1	✱	36.0	1.5	1.0	0.588	142.30	206.40
SHA38T0.6	✱	38.0	0.6		0.256	152.00	89.80
SHA38T1	✱	38.0	1.0		0.422	151.50	148.00
SHA38T0.9	✱	38.0	0.9		0.382	151.90	133.92
SHA38T1.3	✱	38.0	1.3		0.544	151.50	190.84
SHA39T0.8	✱	39.0	0.8		0.348	156.00	122.24
SHA39.5T0.8	✱	39.5	0.8		0.353	157.50	123.90
SHA40T0.8	✱	40.0	0.8		0.358	160.00	125.44
SHA40T1.2	✱	40.0	1.2		0.531	160.00	186.24
SHA40T1.5	✱	40.0	1.5		0.658	160.00	230.92
SHA40T2	✓	40.0	2.0		0.866	160.00	304.00

"✓" Stocked Item  
 "✱" Pre-order Only Item  
 (30-40 working days delivery)



# Square Hollow

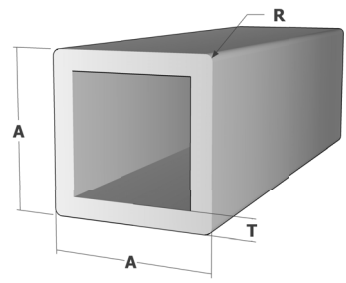

Product Code	Ex Stock	A (mm)	T (mm)	R (mm)	Mass (kg/m)	Perimeter (mm)	Area (mm <sup>2</sup> )
SHRA40T2R3.5	✱	40.0	2.0	3.5	0.842	154.00	295.40
SHRA40T2.5R3.5	✱	40.0	2.5	3.5	1.041	154.00	365.30
SHA40T3	✓	40.0	3.0		1.265	160.00	444.00
SHRA40T3R3	✓	40.0	3.0	3.0	1.243	154.85	436.27
SHA40T4	✓	40.0	4.0		1.642	160.00	576.00
SHA44.5T0.9	✱	44.5	0.9		0.447	117.30	156.78
SHA45T0.6	✱	45.0	0.6		0.304	180.00	106.56
SHA45T0.8	✱	45.0	0.8		0.378	179.49	132.67
SHRA45T1.6R2	✱	45.0	1.6	2.0	0.783	176.60	274.60
SHRA45T2R3.5	✱	45.0	2.0	3.5	0.960	174.00	335.42
SHA50T0.8	✱	50.0	0.8		0.449	199.50	157.44
SHA50T1.0	✱	50.0	1.0		0.559	199.50	196.00
SHA50T1.2	✓	50.0	1.2		0.667	199.50	234.20
SHA50T1.4	✱	50.0	1.4		0.776	200.00	272.16
SHA50T2.0	✓	50.0	2.0		1.094	200.00	384.00
SHRA50T2.0R3	✓	50.0	2.0	3.0	1.075	194.85	377.13
SHA50T2.5	✱	50.0	2.5		1.356	200.00	475.85
SHA50T3	✓	50.0	3.0		1.607	200.00	564.00
SHRA50T3R3	✓	50.0	3.0	3.0	1.585	194.85	556.28
SHA50T3.5	✱	50.0	3.5		1.855	200.00	650.86
SHA50T4	✓	50.0	4.0		2.098	200.00	736.00
SHA50T5	✱	50.0	5.0		2.565	200.00	900.00
SHA60T1.5	✱	60.0	1.5		1.000	239.50	351.00
SHA60T2	✱	60.0	2.0		1.322	240.00	464.00
SHRA60T2R3.5	✱	60.0	2.0	3.5	1.298	221.43	455.42
SHA60T2.5	✓	60.0	2.5		1.639	240.00	575.00
SHRA60T2.7R3.5	✱	60.0	2.7	3.5	1.735	234.00	608.90
SHA60T6	✱	60.0	6.0		3.694	240.00	1296.00
SHRA65T2.5R3	✓	65.0	2.5	3.0	1.760	254.85	617.49
SHRA70T5.8	✱	70.0	4.0		3.010	280.00	1056.00
SHA75T1.6	✓	75.0	1.6		1.339	299.20	469.80
SHA75T3.0	✓	75.0	3.0		2.462	299.50	864.00
SHRA75T3R3	✓	75.0	3.0	3.0	2.440	294.85	856.27
SHA75T4	✓	75.0	4.0		3.238	299.50	1136.00
SHA80T1.5	✱	80.0	1.5		1.342	320.00	471.00
SHA80T1.8	✓	80.0	1.8		1.605	320.00	563.04
SHRA80T2.5R3.5	✱	80.0	2.5	3.5	2.181	314.00	765.34
SHRA80T5R10	✱	80.0	5.0	10.0	4.092	302.80	1435.62
SHRA90T1.6R8	✱	90.0	1.6	8.0	1.556	346.27	545.98
SHA90T1.8	✱	90.0	1.8	3.5	1.810	360.00	635.10

"✓" Stocked Item  
 "✱" Pre-order Only Item  
 (30-40 working days delivery)



# Square Hollow

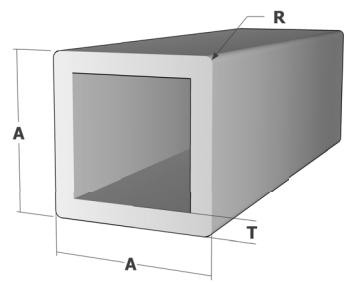

Product Code	Ex Stock	A (mm)	T (mm)	R (mm)	Mass (kg/m)	Perimeter (mm)	Area (mm <sup>2</sup> )
SHA90T1.9	✱	90.0	1.9		1.908	360.00	669.59
SHA90T3	✓	90.0	3.0		2.975	359.14	1043.86
SHA90T6	✓	90.0	6.0		5.746	360.00	2016.00
SHA100T1	✱	100.0	1.0		1.129	400.00	396.00
SHA100T1.3	✱	100.0	1.3		1.463	400.00	513.27
SHA100T2	✱	100.0	2.0		2.234	400.00	784.00
SHRA100T3R3	✓	100.0	3.0	3.0	3.296	394.85	1156.50
SHA100T3	✓	100.0	3.0		3.317	400.00	1164.00
SHA100T4	✓	100.0	4.0		4.378	400.00	1536.00
SHA100T5	✓	100.0	5.0		5.415	400.00	1900.00
SHA120T3R3	✓	120.0	3.0	3.0	4.000	478.30	1403.40
SHA150T3	✓	150.0	3.0		5.027	600.00	1764.00
SHA150T10	✱	150.0	10.0		5.027	600.00	1764.00
SHA200T10	✱	150.0	10.0		5.027	600.00	1764.00



"✓" Stocked Item  
 "✱" Pre-order Only Item  
 (30-40 working days delivery)



# Rectangular Hollow

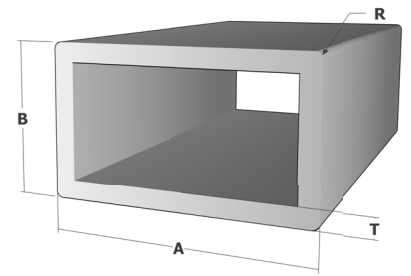

Product Code	Ex Stock	A (mm)	B (mm)	T (mm)	R (mm)	Mass (kg/m)	Perimeter (mm)	Area (mm <sup>2</sup> )
RHA15B10T1	*	15.0	10.0	1.0		0.131	50.00	46.00
RHA15B12T1.2	*	15.0	12.0	1.2		0.168	54.00	59.04
RHRA17.8B13.8T1.4R2	*	17.8	13.8	1.4	2.0	0.226	59.80	79.14
RHRA18B14T2R1.5	*	18.0	14.0	2.0	1.5	0.314	61.43	110.10
RHA18.1B7.2T1.5	*	18.1	7.2	1.5		0.191	50.09	66.90
RHRA18.5B13T1R1.3	*	18.5	13.0	1.0	1.3	0.165	60.86	57.87
RHA20B10T1.2	*	20.0	10.0	1.2		0.189	59.50	66.24
RHA20B12T1.2	*	20.0	12.0	1.2		0.202	64.00	71.00
RHRA20B15T1.4R1	*	20.0	15.0	1.4	1.0	0.255	69.50	89.38
RHA20B15T2	✓	20.0	15.0	2.0		0.353	70.00	124.00
RHA21B12.5T1	*	21.0	12.5	1.0		0.180	66.50	63.00
RHA22B10T2	*	22.0	10.0	2.0		0.319	64.00	112.00
RHRA22.3B18.3T0.8R1	*	22.3	18.3	0.8	1.0	0.175	80.68	61.56
RHRA23B17T1.2R3	*	23.0	17.0	1.2	3.0	0.234	74.90	85.30
RHA23.8B10.9T1	*	23.8	10.9	1.0		0.186	68.54	65.4
RHA24B8T2	*	24.0	8.0	2.0		0.319	64.00	112.00
RHRA25B9T1.2R2	*	25.0	9.0	1.2	2.0	0.208	64.60	73.00
RHA25B15T0.45	*	25.0	15.0	0.45		0.100	79.70	35.20
RHA25B15T1	*	25.0	15.0	1.0		0.217	79.50	76.00
RHRA25B15T2.5R2	*	25.0	15.0	2.5	2.0	0.496	76.60	174.20
RHA25B20T1	*	25.0	20.0	1.0		0.245	89.50	86.00
RHA25.1B10.1T0.8	*	25.1	10.1	0.8		0.153	70.00	53.76
RHA25.4B12.7T0.9	*	25.4	12.7	0.9		0.186	75.69	65.34
RHA26.1B16.5T0.52	*	26.1	16.5	0.52		0.123	85.20	43.22
RHA28B15T1	*	28.0	15.0	1.0		0.234	85.50	82.00
RHRA28B18T0.7R4	*	28.0	18.0	0.7	4.0	0.165	85.10	58.05
RHA29.2B10T0.65	*	29.2	10.0	0.65		0.171	77.59	59.84
RHRA29.9B19.9T1R1.5	*	29.9	19.9	1.0	1.5	0.267	98.86	93.70
RHRA30B10T1.5R1.5	*	30.0	10.0	1.5	1.5	0.311	77.40	109.20
RHA30B10T2	*	30.0	10.0	2.0		0.405	79.00	142.00
RHA30B15T1	*	30.0	15.0	1.0		0.245	90.00	86.00
RHA30B15T1.2	*	30.0	15.0	1.2		0.291	89.50	102.20
RHRA30B15T2R2.5	*	30.0	15.0	2.0	2.5	0.453	85.70	158.90
RHRA30B15T2.2R2	*	30.0	15.0	2.2	2.0	0.500	86.60	175.40
RHA30B18T1	*	30.0	18.0	1.0		0.262	95.50	92.00
RHRA30B18T1.5R2	*	30.0	18.0	1.5	2.0	0.375	92.56	131.58
RHA30B20T0.8	✓	30.0	20.0	0.8		0.221	100.00	77.50
RHRA30B20T1R1.5	*	30.0	20.0	1.0	1.5	0.269	97.40	94.30
RHA30B20T1.2	*	30.0	20.0	1.2		0.325	99.50	114.20
RHRA30B20T1.5R1.5	*	30.0	20.0	1.5	1.5	0.397	97.42	139.14

“✓” Stocked Item  
 “✳” Pre-order Only Item  
 (30-40 working days delivery)



# Rectangular Hollow

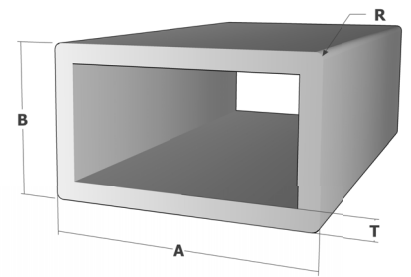

Product Code	Ex Stock	A (mm)	B (mm)	T (mm)	R (mm)	Mass (kg/m)	Perimeter (mm)	Area (mm <sup>2</sup> )
RHRA30B20T1.6R1.5	*	30.0	20.0	1.6	1.5	0.422	97.40	147.90
RHA30B20T1.8	✓	30.0	20.0	1.8		0.476	100.00	167.00
RHRA32B16T1.5R2.2	*	32.0	16.0	1.5	2.2	0.385	92.22	135.00
RHRA32B27T1.8R1	*	32.0	27.0	1.8	1.0	0.566	116.28	198.66
RHRA34.5B12T1.2R1	*	34.5	12.0	1.2	1.0	0.300	91.50	105.20
RHRA34.8B24.8T0.65R2	*	34.8	24.8	0.65	2.0	0.211	116.00	73.92
RHA35B20T0.4	*	35.0	20.0	0.4		0.123	109.49	66.24
RHA35B20T0.5	*	35.0	20.0	0.5		0.154	109.50	43.28
RHRA35B25T1.5R3	*	35.0	25.0	1.5	3.0	0.471	114.85	165.20
RHA36B23T0.5	*	36.0	23.0	0.5		0.165	117.50	58.00
RHA37.2B24.2T1.1	*	37.2	24.2	1.1		0.371	122.30	130.24
RHRA38B7T1.2R1	*	38.0	7.0	1.2	1.0	0.289	88.30	101.50
RHA38B13T2.5	*	38.0	13.0	2.5		0.654	102.50	229.64
RHA38B25T0.5	*	38.0	25.0	0.5		0.177	125.50	112.00
RHA38B25T0.6	*	38.0	25.0	0.6		0.211	126.00	62.00
RHA38B25T0.9	*	38.0	25.0	0.9		0.314	125.50	74.16
RHA38B25T1	*	38.0	25.0	1.0		0.348	126.00	110.20
RHA38B25T1.2	*	38.0	25.0	1.2		0.415	126.00	122.00
RHRA38B25T1.5R3	✓	38.0	25.0	1.5	3.0	0.496	120.85	174.21
RHA38B25T2	✓	38.0	25.0	2.0		0.672	125.14	235.86
RHRA38B25T2.5R3	✓	38.0	25.0	2.5	3.0	0.805	120.85	282.49
RHA38B25T3	*	38.0	25.0	3.0		0.975	126.00	342.00
RHA38B25.4T0.9	*	38.0	25.4	0.9		0.317	126.50	111.10
RHA40B20T0.75	*	40.0	20.0	0.75		0.250	120.00	87.75
RHA40B20T0.9	*	40.0	20.0	0.9		0.298	119.49	104.68
RHA40B20T1	*	40.0	20.0	1.0		0.329	119.49	115.41
RHA40B20T1.2	✓	40.0	20.0	1.2		0.394	119.50	138.20
RHRA40B20T1.6R2	✓	40.0	20.0	1.6	2.0	0.509	116.60	178.54
RHRA40B20T2R2	*	40.0	20.0	2.0	2.0	0.629	116.57	220.64
RHA40B20T2.5	*	40.0	20.0	2.5		0.784	120.00	275.00
RHA40B20T3	✓	40.0	20.0	3.0		0.923	120.00	324.00
RHA40B25T2	✓	40.0	25.0	2.0		0.695	130.00	244.00
RHRA40B25T2.5R3	*	40.0	25.0	2.5	3.0	0.834	124.85	292.49
RHA40B30T0.7	*	40.0	30.0	0.7		0.274	139.49	96.04
RHA40.6B23.6T0.8	*	40.6	23.6	0.8		0.286	128.40	100.20
RHA42.4B35T2	*	42.4	35.0	2.0		0.832	154.00	292.00
RHA45B20T1.5	*	45.0	20.0	1.5		0.530	129.66	186.00
RHA45B25T0.6	*	45.0	25.0	0.6		0.235	140.00	82.56
RHRA45B35T1R2	*	45.0	35.0	1.0	2.0	0.437	156.57	153.43
RHA45B40T3	*	45.0	40.0	3.0		1.351	170.00	474.00

"✓" Stocked Item  
 "✱" Pre-order Only Item  
 (30-40 working days delivery)



# Rectangular Hollow

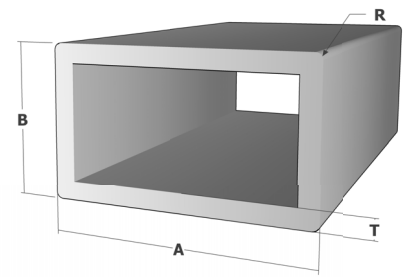

Product Code	Ex Stock	A (mm)	B (mm)	T (mm)	R (mm)	Mass (kg/m)	Perimeter (mm)	Area (mm <sup>2</sup> )
RHRA50B20T0.8R3	*	50.0	20.0	0.8	3.0	0.305	135.00	107.00
RHA50B25T0.6	*	50.0	25.0	0.6		0.252	149.50	88.56
RHA50B25T0.8	*	50.0	25.0	0.8		0.314	149.49	110.17
RHA50B25T1.2	✓	50.0	25.0	1.2		0.496	150.00	174.20
RHA50B25T1.6	✓	50.0	25.0	1.6		0.654	149.00	229.60
RHA50B25T2.5	*	50.0	25.0	2.5		0.998	150.00	350.00
RHA50B25T3	✓	50.0	25.0	3.0		1.180	150.00	414.00
RHRA50B25T3R3	✓	50.0	25.0	3.0	3.0	1.158	144.85	406.27
RHA50B30T1.2	*	50.0	30.0	1.2		0.531	160.00	186.20
RHA50B30T1.5	*	50.0	30.0	1.5		0.658	160.00	231.00
RHA50B30T2	*	50.0	30.0	2.0		0.866	160.00	304.00
RHA50B34T1.5	*	50.0	34.0	1.5		0.693	168.00	243.00
RHRA50B34T1.5R3.5	*	50.0	34.0	1.5	3.5	0.888	162.00	311.40
RHA50B35T3	*	50.0	35.0	3.0		1.351	170.00	474.00
RHA50B38.5T2	*	50.0	38.5	2.0		0.963	176.14	338.00
RHA50B40T2	✓	50.0	40.0	2.0		0.980	180.00	344.00
RHRA50B40T2R3	✓	50.0	40.0	2.0	3.0	0.961	126.00	122.00
RHRA50B40T3R5	*	50.0	40.0	3.0	5.0	0.496	120.85	174.21
RHA50.2B25.4T0.9	*	50.2	25.4	0.9		0.672	125.14	235.86
RHA50.8B38.1T0.9	*	50.8	38.1	0.9		0.805	120.85	282.49
RHRA51B39T1.8R1.5	*	51.0	39.0	1.8	1.5	0.975	126.00	342.00
RHA53B30T1	*	53.0	30.0	1.0		0.462	165.49	162.00
RHA54.7B11T0.7	*	54.7	11.0	0.7		0.317	126.50	111.10
RHA55B9T1.3	*	55.0	9.0	1.3		0.250	120.00	87.75
RHA55B15T0.7	*	55.0	15.0	0.7		0.324	139.49	113.72
RHA55B22T0.7	✓	55.0	22.0	0.7		0.298	119.49	104.68
RHA55B30T1	*	55.0	30.0	1.0		0.473	170.00	166.00
RHRA55B40T4R2	*	55.0	40.0	4.0	2.0	1.984	186.70	696.00
RHRA55.5B11.2T0.8R1.5	*	55.5	11.2	0.8	1.5	0.297	130.82	104.16
RHA59B18T1.5	*	59.0	18.0	1.5		0.633	154.00	222.00
RHA60B20T1.2	*	60.0	20.0	1.2		0.531	159.50	186.20
RHRA60B25T1.3R3	*	60.0	25.0	1.3	3.0	0.596	164.85	209.00
RHRA60B25T1.5R3	*	60.0	25.0	1.5	3.0	0.701	164.90	246.00
RHRA60B25T1.5R5.5	*	60.0	25.0	1.5	5.5	0.672	160.56	235.91
RHRA60B26T2R5	*	60.0	26.0	2.0	5.0	0.896	163.42	314.27
RHA60B40T2	✓	60.0	40.0	2.0		1.094	200.00	384.00
RHRA60B40T2R6	✓	60.0	40.0	2.0	6.0	1.075	195.0	377.13
RHA60B40T2.5	*	60.0	40.0	2.5		1.354	199.50	475.00
RHA60B40T3	✓	60.0	40.0	3.0		1.607	199.20	563.90
RHRA60B40T3R6	*	60.0	40.0	3.0	6.0	1.600	196.57	561.42

"✓" Stocked Item  
 "✱" Pre-order Only Item  
 (30-40 working days delivery)



# Rectangular Hollow

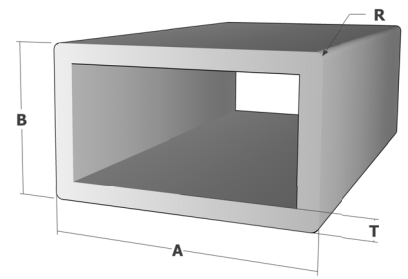

Product Code	Ex Stock	A (mm)	B (mm)	T (mm)	R (mm)	Mass (kg/m)	Perimeter (mm)	Area (mm <sup>2</sup> )
RHA60B40T3.8	*	60.0	40.0	3.8		2.001	200.00	702.24
RHA60B40T4	✓	60.0	40.0	4.0		2.098	200.00	736.00
RHRA60B40T5R2	*	60.0	40.0	5.0	2.0	2.555	196.57	896.57
RHRA62.8B17.6T0.8R4	*	62.8	17.6	0.8	4.0	0.345	153.93	121.14
RHA64B25T0.9	*	64.0	25.0	0.9		0.447	178.00	156.96
RHRA65B16T1.2R2	✓	65.0	16.0	1.2	2.0	0.568	161.50	199.30
RHA65B16T1.2	*	65.0	16.0	1.2		0.529	158.57	185.76
RHA65B50T3	✓	65.0	50.0	3.0		1.864	229.14	653.86
RHA69.9B19.9T0.9	*	69.9	19.9	0.9		0.451	179.00	158.31
RHA70B20T1	*	70.0	20.0	1.0		0.500	179.49	175.41
RHRA70B25T4R2	*	70.0	25.0	4.0	2.0	1.984	190.00	696.00
RHRA70B25.5T0.9R3.5	*	70.0	25.5	0.9	3.5	0.447	184.99	156.83
RHA70B30.2T1	*	70.0	30.2	1.0		0.450	199.89	157.76
RHA70B40T3	✓	70.0	40.0	3.0		1.778	219.14	623.86
RHA71.6B21.3T1	*	71.6	21.3	1.0		0.518	185.29	181.80
RHRA74B25T1.8R3	*	74.0	25.0	1.8	3.0	1.052	192.85	369.11
RHA75B25T2.2	✓	75.0	25.0	2.2		1.199	199.20	420.70
RHA75B40T2	✓	75.0	40.0	2.0		1.265	230.00	444.00
RHA75B45T0.8	*	75.0	45.0	0.8		0.507	239.50	177.80
RHA75B45T3	✓	75.0	45.0	3.0		1.949	239.14	683.86
RHA75B50T3	✓	75.0	50.0	3.0		2.035	249.50	714.00
RHA76B25T1.2	*	76.0	25.0	1.2		0.674	201.50	236.60
RHA76B25T1.5	*	76.0	25.0	1.5		0.838	201.50	294.00
RHA76B44T0.7	*	76.0	44.0	0.7		0.473	240.00	166.00
RHA76B44T1	*	76.0	44.0	1.0		0.673	240.00	236.00
RHA76B44T1.2	*	76.0	44.0	1.2		0.804	240.00	282.20
RHA76B44T1.4	*	76.0	44.0	1.4		0.935	240.00	328.00
RHA76B44T1.5	*	76.0	44.0	1.5		1.000	240.00	351.00
RHA76B44T2.0	✓	76.0	44.0	2.0		1.322	240.00	464.00
RHA76B25.4T0.9	✓	76.0	25.4	0.9		0.512	202.70	179.60
RHA76B44.5T0.9	*	76.0	44.5	0.9		0.610	240.80	214.00
RHRA77B32T2.7R3	✓	77.0	32.0	2.7	3.0	1.573	212.85	551.80
RHRA78.6B35.4T2R3	*	78.6	35.4	2.0	3.0	1.234	222.85	433.13
RHRA79.5B19.9T0.85	*	79.5	19.9	0.85		0.473	198.00	166.10
RHA80B20T0.7	✓	80.0	20.0	0.7		0.449	199.50	157.50
RHA80B25T1	*	80.0	25.0	1.0		0.587	209.50	206.00
RHA80B40T0.9	*	80.0	40.0	0.9		0.573	240.00	201.11
RHA80B40T1.5	*	80.0	40.0	1.5		1.000	240.00	350.90
RHA80B40T1.8	*	80.0	40.0	1.8		1.194	240.00	419.00
RHRA80B40T2R3	✓	80.0	40.0	2.0	3.0	1.303	243.85	457.13



"✓" Stocked Item  
 "✱" Pre-order Only Item  
 (30-40 working days delivery)



# Rectangular Hollow

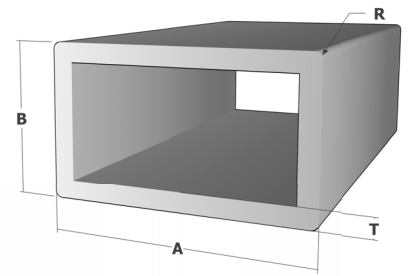

Product Code	Ex Stock	A (mm)	B (mm)	T (mm)	R (mm)	Mass (kg/m)	Perimeter (mm)	Area (mm <sup>2</sup> )
RHRA80B40T3.5R3	*	80.0	40.0	3.5	3.0	2.254	234.80	791.00
RHA80B50T3	✓	80.0	50.0	3.0		2.120	260.00	744.00
RHRA80B50T3R3	✓	80.0	50.0	3.0	3.0	2.098	254.85	736.28
RHA80B60T6	*	80.0	60.0	6.0		4.378	280.00	1536.00
RHA90B25T4	*	90.0	25.0	4.0		2.440	229.50	856.00
RHA90B50T2	✓	90.0	50.0	2.0		1.550	279.14	543.86
RHA90B50T6	✓	90.0	50.0	6.0		4.378	280.00	1536.00
RHA90B60T3	*	90.0	60.0	3.0		2.384	300.00	836.50
RHRA90B60T5R5	*	90.0	60.0	5.0	5.0	4.051	300.00	1421.46
RHA100B15T1.2	*	100.0	15.0	1.2		0.770	229.50	270.20
RHA100B15T1.3	*	100.0	15.0	1.3		0.833	230.00	292.24
RHRA100B18T2.3R2	*	100.0	18.0	2.3	2.0	1.388	236.00	486.91
RHA100B19.7T1.4	✓	100.0	19.7	1.4		0.933	238.50	372.20
RHA100B20T0.8	*	100.0	20.0	0.8		0.540	240.00	189.44
RHA100B20T1.2	*	100.0	20.0	1.2		0.804	239.49	282.24
RHA100B25T1.5	*	100.0	25.0	1.5		1.043	250.00	366.00
RHA100B25T2.5	✓	100.0	25.0	2.5		1.710	249.20	600.00
RHA100B30T1.5	*	100.0	30.0	1.5		1.086	260.00	381.00
RHA100B40T0.9	*	100.0	40.0	0.9		0.709	280.00	248.76
RHA100B40T2	*	100.0	40.0	2.0		1.550	280.00	544.00
RHA100B44T1.4	✓	100.0	44.0	1.4		1.127	288.00	395.40
RHA100B44T2	*	100.0	44.0	2.0		1.596	288.00	560.10
RHA100B44T3	*	100.0	44.0	3.0		2.360	288.00	828.00
RHA100B45T0.8	*	100.0	45.0	0.8		0.613	289.49	215.17
RHA100B45T3	*	100.0	45.0	3.0		2.377	290.00	834.00
RHA100B45T4	*	100.0	45.0	4.0		3.124	290.00	1096.00
RHA100B50T1.5	*	100.0	50.0	1.5		1.257	300.00	441.00
RHA100B50T2.5	*	100.0	50.0	2.5		2.066	300.00	725.00
RHA100B50T3	✓	100.0	50.0	3.0		2.462	300.00	864.00
RHRA100B50T3R3	✓	100.0	50.0	3.0	3.0	2.440	294.85	856.28
RHA100B50T6	✓	100.0	50.0	6.0		4.719	299.20	1655.90
RHRA100B55T2.5R1.5	*	100.0	55.0	2.5	1.5	2.135	307.00	749.00
RHA100B60T2	*	100.0	60.0	2.0		1.778	320.00	624.00
RHRA100B60T5R1	*	100.0	60.0	5.0	1.0	4.273	318.28	1499.22
RHA100B80T1.8	*	100.0	80.0	1.8		1.810	360.00	635.00
RHA100B80T2	✓	100.0	80.0	2.0		2.006	360.00	704.00
RHRA101.6B25.4T0.9	*	101.6	25.4	0.9		0.642	253.50	225.40
RHA101.6B44.5T1	*	101.6	44.0	1.0		0.659	240.00	419.00
RHRA102B75T2.5R7.5	*	102.0	75.0	2.5	7.5	2.375	341.12	833.18
RHA120B25T4	✓	120.0	25.0	4.0		3.124	290.00	1096.00

"✓" Stocked Item  
 "✱" Pre-order Only Item  
 (30-40 working days delivery)



# Rectangular Hollow

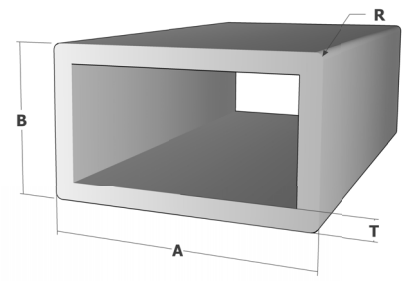

Product Code	Ex Stock	A (mm)	B (mm)	T (mm)	R (mm)	Mass (kg/m)	Perimeter (mm)	Area (mm <sup>2</sup> )
RHA120B60T2	✱	120.0	60.0	2.0		2.006	360.00	704.00
RHA120B60T2.9	✓	120.0	60.0	2.9		2.880	360.00	1010.40
RHA120B60T5	✓	120.0	60.0	5.0		2.098	254.85	736.28
RHA120B60T6	✓	120.0	60.0	6.0		4.378	280.00	1536.00
RHRA120B66T3.9R2	✱	120.0	66.0	3.9	2.0	2.440	229.50	856.00
RHA120B80T6	✱	120.0	80.0	6.0		1.550	279.14	543.86
RHA125B30T2.5	✱	125.0	30.0	2.5		2.138	310.00	750.00
RHA125B40T3	✓	125.0	40.0	3.0		2.719	329.20	954.00
RHA125B50T3	✓	125.0	50.0	3.0		2.890	349.14	1013.86
RHA150B30T2.5	✱	150.0	30.0	2.5		2.494	360.00	875.00
RHA150B50T2.5	✱	150.0	50.0	2.5		2.779	400.00	975.00
RHA150B50T3	✓	150.0	50.0	3.0		3.317	400.00	1164.00
RHA150B76T2.5	✱	150.0	76.0	2.5		3.149	452.00	1105.00
RHA150B100T2.5	✓	150.0	100.0	2.5		3.445	500.00	1208.92
RHRA154.9B79.7T6R14.6	✱	154.9	79.7	6.0	14.6	7.358	444.24	2581.72
RHA160B60T4	✓	160.0	60.0	4.0		4.834	440.00	1696.00
RHA160B60T5	✱	160.0	60.0	5.0		5.985	440.00	2100.00
RHRA160B148.5T6R10	✱	160.0	148.5	6.0	10.0	9.935	599.83	3485.90
RHRA160B150T6R10	✱	160.0	150.0	6.0	10.0	9.600	602.83	3503.90
RHRA169B86.2T6R15.1	✱	169.0	86.2	6.0	15.1	10.600	484.57	2816.07
RHA171B93T10	✱	171.0	93.0	10.0		13.959	527.14	4897.79
RHA173B73T5	✱	173.0	73.0	5.0		6.726	492.00	2360.00
RHRA174B86.6T7.5R5	✱	174.0	86.6	7.5	5.0	11.600	512.62	3666.69
RHA180B80T3	✓	180.0	80.0	3.0		4.340	520.00	1524.10
RHA200B30T2.8	✱	200.0	30.0	2.8		3.519	460.00	1234.75
RHA200B50T3	✓	200.0	50.0	3.0		4.172	500.00	1464.00
RHA200B60T2	✱	200.0	60.0	2.0		2.918	520.00	1024.00
RHA200B75T3	✓	200.0	75.0	3.0		4.600	549.50	1614.00
RHA200B100T3	✓	200.0	100.0	3.0		5.027	600.00	1764.00
RHA232B74T10	✱	232.0	74.0	10.0		16.393	611.14	5751.79
RHA250B50T3	✓	250.0	50.0	3.0		5.027	600.00	1764.00
RHA300B50T3	✓	300.0	50.0	3.0		6.047	699.00	2121.87
RHA317B220T16	✱	317.0	220.0	16.0		46.117	1074.00	16181.46

"✓" Stocked Item  
 "✱" Pre-order Only Item  
 (30-40 working days delivery)



# Round Tubes

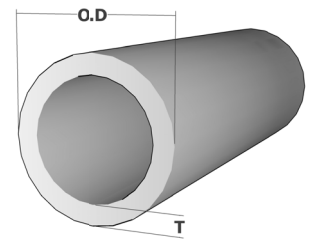

Product Code	Ex Stock	O.D (mm)	T (mm)	Mass (kg/m)	Perimeter (mm)	Area (mm <sup>2</sup> )
RTD8T1.2	✱	8.0	1.2	0.073	50.00	46.00
RTD8T1.5	✱	8.0	1.5	0.087	54.00	59.04
RTD8.9T1.8	✱	8.9	1.8	0.114	27.95	79.14
RTD8.9T1.55	✱	8.9	1.55	0.102	27.95	110.10
RTD9T1.4	✱	9.0	1.4	0.095	28.27	57.87
RTD9T2	✓	9.0	2.0	0.125	28.26	66.24
RTD9.53T1.42	✱	9.5	0.9	0.069	29.85	24.32
RTD9.53T1.42	✓	9.53	1.42	0.103	29.92	71.00
RTD10T1	✱	10.0	1.0	0.081	31.40	124.00
RTD10T1.2	✓	10.0	1.2	0.095	31.40	63.00
RTD10T1.5	✱	10.0	1.5	0.114	31.42	112.00
RTD10T2	✱	10.0	2.0	0.143	31.42	61.56
RTD10.6T1.6	✱	10.6	1.6	0.129	33.28	45.21
RTD11T0.7	✱	11.0	0.7	0.065	34.60	22.65
RTD11T2	✱	11.0	2.0	0.161	34.56	56.55
RTD11T3	✱	11.0	3.0	0.215	34.56	75.40
RTD11.5T0.8	✱	11.5	0.8	0.077	36.11	26.88
RTD11.8T0.55	✱	11.8	0.55	0.080	37.05	19.43
RTD11.8T0.95	✱	11.8	0.95	0.089	37.07	32.38
RTD12T0.8	✱	12.0	0.8	0.080	37.68	28.13
RTD12T0.9	✱	12.0	0.9	0.089	37.68	31.37
RTD12T1	✱	12.0	1.0	0.098	37.68	34.54
RTD12T1.2	✱	12.0	1.2	0.116	37.68	40.69
RTD12T2	✱	12.0	2.0	0.179	37.70	62.83
RTD12T2.6	✱	12.0	2.6	0.219	37.70	76.78
RTD12T2.6	✱	12.0	2.6	0.219	37.70	76.78
RTD12T3.9	✱	12.0	3.9	0.283	37.70	99.24
RTD12.4T0.8	✱	12.4	0.8	0.083	38.84	29.14
RTD12.5T2	✱	12.5	2.0	0.188	39.27	65.97
RTD12.7T1.4	✓	12.7	1.4	0.142	39.88	49.68
RTD13T1	✱	13.0	1.0	0.107	40.80	37.70
RTD13T1.1	✱	13.0	1.1	0.117	90.00	86.00
RTD13T1.2	✱	13.0	1.2	0.349	89.50	102.20
RTD13T1.4	✱	13.0	1.4	0.453	85.70	158.90
RTD13T2	✱	13.0	2.0	0.500	86.60	175.40
RTD13T4.7	✱	13.0	4.7	0.262	95.50	92.00
RTD13.7T2	✱	13.7	2.0	0.209	43.02	73.48
RTD13.8T0.5	✱	13.8	0.5	0.060	43.35	20.89
RTD14T0.65	✱	14.0	0.65	0.078	43.96	27.25
RTD14T0.7	✱	14.0	0.7	0.083	43.96	29.23

"✓" Stocked Item  
 "✱" Pre-order Only Item  
 (30-40 working days delivery)



# Round Tubes

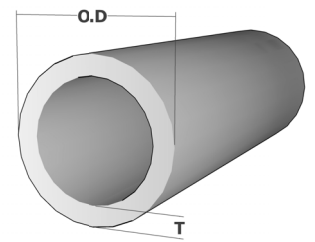

Product Code	Ex Stock	O.D (mm)	T (mm)	Mass (kg/m)	Perimeter (mm)	Area (mm <sup>2</sup> )
RTD14T0.8	✱	14.0	0.8	0.095	43.96	33.16
RTD14T0.9	✱	14.0	0.9	0.106	43.96	37.02
RTD14T1.2	✱	14.0	1.2	0.137	43.96	48.23
RTD14T1.5	✱	14.0	1.5	0.168	43.96	58.88
RTD14T2	✱	14.0	2.0	0.215	44.00	75.40
RTD14T3.6	✱	14.0	3.6	0.335	44.00	117.62
RTD14.5T3.85	✱	14.5	3.85	0.367	45.55	128.81
RTD14.8T1.2	✱	14.8	1.2	0.146	46.50	51.27
RTD15T0.5	✱	15.0	0.5	0.065	47.12	22.78
RTD15T0.65	✱	15.0	0.65	0.083	47.10	29.29
RTD15T0.8	✱	15.0	0.8	0.102	47.10	35.67
RTD15T1	✱	15.0	1.0	0.125	47.12	43.98
RTD15T1.1	✱	15.0	1.1	0.137	47.13	48.04
RTD15T1.2	✱	15.0	1.2	0.148	47.10	52.00
RTD15T2	✱	15.0	2.0	0.233	47.13	81.68
RTD15T1.41	✓	15.0	1.41	0.170	47.10	59.79
RTD15T4.1	✱	15.0	4.1	0.400	47.13	140.40
RTD16T0.6	✱	16.0	0.6	0.083	50.24	29.01
RTD16T0.7	✱	16.0	0.7	0.096	50.27	33.65
RTD16T0.8	✱	16.0	0.8	0.109	50.24	38.18
RTD16T1	✱	16.0	1.0	0.134	50.24	47.10
RTD16T1.1	✱	16.0	1.1	0.147	50.24	51.47
RTD16T1.2	✱	16.0	1.2	0.159	50.24	55.77
RTD16T1.3	✓	16.0	1.3	0.171	50.24	60.00
RTD16T2	✱	16.0	2.0	0.251	50.27	88.00
RTD16T3	✱	16.0	3.0	0.349	50.27	122.52
RTD16T4	✱	16.0	4.0	0.430	50.27	150.80
RTD16T4.6	✱	16.0	4.6	0.470	50.27	164.75
RTD16.5T1.2	✱	16.5	1.2	0.164	51.81	57.65
RTD17T1	✱	17.0	1.0	0.143	53.41	50.27
RTD17T2	✱	17.0	2.0	0.269	53.41	94.25
RTD17T3	✱	17.0	3.0	0.376	53.41	132.00
RTD17T4	✱	17.0	4.0	0.466	53.41	163.36
RTD17T5.1	✱	17.0	5.1	0.543	53.41	190.66
RTD17T5.6	✱	17.0	5.6	0.572	53.41	200.56
RTD17T5.9	✱	17.0	5.9	0.586	53.38	205.64
RTD17.5T2	✱	17.5	2.0	0.277	54.95	27.25
RTD18T1	✱	18.0	1.0	0.152	56.55	29.23
RTD18T1.2	✱	18.0	1.2	0.180	56.52	33.16
RTD18T1.5	✱	18.0	1.5	0.221	56.52	37.02

"✓" Stocked Item  
 "✱" Pre-order Only Item  
 (30-40 working days delivery)



# Round Tubes

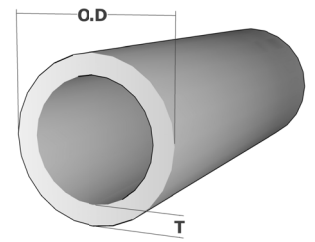

Product Code	Ex Stock	O.D (mm)	T (mm)	Mass (kg/m)	Perimeter (mm)	Area (mm <sup>2</sup> )
RTD18T2	✱	18.0	2.0	0.287	56.55	100.53
RTD18T3	✱	18.0	3.0	0.403	56.55	141.37
RTD18T4	✱	18.0	4.0	0.502	56.55	176.00
RTD18T5.6	✱	18.0	5.6	0.622	56.55	218.15
RTD18T6.1	✱	18.0	6.1	0.650	56.55	228.05
RTD18.5T6.65	✱	18.5	6.7	0.701	58.12	245.90
RTD18.6T0.8	✱	18.6	0.8	0.128	58.43	44.80
RTD19T0.6	✱	19.0	0.6	0.099	59.69	34.68
RTD19T0.7	✱	19.0	0.7	0.115	59.66	40.22
RTD19T0.8	✱	19.0	0.8	0.130	59.70	45.74
RTD19T0.9	✱	19.0	0.9	0.146	59.66	51.15
RTD19T1	✱	19.0	1.0	0.161	59.66	56.52
RTD19T1.1	✱	19.0	1.1	0.176	59.66	61.83
RTD19T1.2	✓	19.0	1.2	0.191	59.66	67.07
RTD19T1.4	✓	19.0	1.4	0.221	59.66	77.37
RTD19T1.5	✱	19.0	1.5	0.235	59.66	82.43
RTD19T1.6	✓	19.0	1.6	0.249	59.66	87.42
RTD19T1.85	✱	19.0	1.85	0.284	59.66	99.62
RTD19T2	✓	19.0	2.0	0.304	59.66	106.76
RTD19T3	✱	19.0	3.0	0.430	59.69	150.80
RTD19T4	✱	19.0	4.0	0.537	60.00	188.50
RTD19T6.1	✱	19.0	6.1	0.705	59.70	247.21
RTD19T6.6	✱	19.0	6.6	0.733	59.70	257.11
RTD19.2T1.5	✱	19.2	1.5	0.238	60.29	83.37
RTD19.3T1.4	✱	19.3	1.4	0.224	60.60	78.69
RTD20T0.7	✱	20.0	0.7	0.121	62.80	42.42
RTD20T1	✱	20.0	1.0	0.170	62.80	59.66
RTD20T1.2	✓	20.0	1.2	0.202	62.80	70.84
RTD20T1.3	✱	20.0	1.3	0.143	62.80	76.33
RTD20T1.5	✱	20.0	1.5	0.269	62.80	87.14
RTD20T2	✱	20.0	2.0	0.376	62.83	113.10
RTD20T3	✱	20.0	3.0	0.466	62.83	160.22
RTD20T4	✱	20.0	4.0	0.543	62.83	201.10
RTD20T6.6	✱	20.0	6.6	0.572	62.83	277.84
RTD20T6.85	✱	20.0	6.85	0.586	62.80	282.84
RTD20T7.1	✱	20.0	7.1	0.277	62.83	287.74
RTD20.2T5.8	✱	20.2	5.8	0.152	63.43	262.25
RTD20.5T1	✱	20.5	1.0	0.180	64.40	61.26
RTD20.5T2	✱	20.5	2.0	0.331	64.40	116.24
RTD21T0.8	✱	21.0	0.8	0.145	65.94	50.74

"✓" Stocked Item  
 "✱" Pre-order Only Item  
 (30-40 working days delivery)



# Round Tubes

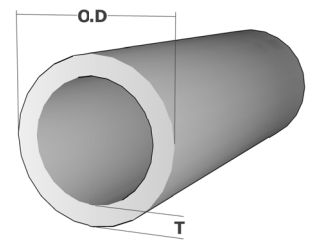

Product Code	Ex Stock	O.D (mm)	T (mm)	Mass (kg/m)	Perimeter (mm)	Area (mm <sup>2</sup> )
RTD21T1	✱	21.0	1.0	0.179	66.00	62.83
RTD21T2	✱	21.0	2.0	0.340	66.00	119.40
RTD21T2.3	✱	21.0	2.3	0.385	65.94	135.05
RTD21T2.5	✱	21.0	2.5	0.414	65.97	145.30
RTD21T3	✱	21.0	3.0	0.484	66.00	169.65
RTD21T4	✱	21.0	4.0	0.609	66.00	213.63
RTD21T5	✱	21.0	5.0	0.716	66.00	251.33
RTD21T7.1	✱	21.0	7.1	0.884	65.97	310.00
RTD21T7.6	✱	21.0	7.6	0.912	66.00	319.94
RTD21.5T2	✱	21.5	2.0	0.349	67.54	122.52
RTD21.6T0.8	✱	21.6	0.8	0.149	67.86	52.34
RTD21.7T0.65	✱	21.7	0.65	0.123	68.17	43.00
RTD21.9T3	✱	21.9	3.0	0.507	68.77	178.04
RTD21.8T0.8	✱	21.8	0.8	0.150	68.45	52.75
RTD22T0.7	✱	22.0	0.7	0.133	69.08	46.82
RTD22T0.8	✱	22.0	0.8	0.152	69.12	53.30
RTD22T0.9	✱	22.0	0.9	0.170	69.08	59.63
RTD22T1	✓	22.0	1.0	0.188	69.12	65.94
RTD22T1.1	✱	22.0	1.1	0.206	69.08	72.23
RTD22T1.2	✱	22.0	1.2	0.223	69.08	78.37
RTD22T1.4	✱	22.0	1.4	0.258	69.08	90.56
RTD22T1.8	✱	22.0	1.8	0.325	69.08	114.17
RTD22T2	✱	22.0	2.0	0.358	69.08	125.60
RTD22T2.15	✱	22.0	2.15	0.382	69.08	134.01
RTD22T2.6	✱	22.0	2.6	0.451	69.08	158.38
RTD22T3	✱	22.0	3.0	0.510	69.11	179.10
RTD22T4	✱	22.0	4.0	0.645	69.11	226.20
RTD22T5	✱	22.0	5.0	0.761	69.11	267.00
RTD22T8.1	✱	22.0	8.1	1.008	69.11	353.71
RTD22.2T1.1	✱	22.2	1.1	0.208	69.71	72.88
RTD22.5T1	✱	22.5	1.0	0.192	70.70	67.54
RTD21.5T0.55	✱	21.5	0.55	0.109	71.00	38.10
RTD22.8T1.3	✱	22.8	1.3	0.250	71.59	87.76
RTD23T1	✱	23.0	1.0	0.197	72.26	69.11
RTD23T2	✱	23.0	2.0	0.376	72.26	132.00
RTD23T3	✱	23.0	3.0	0.537	72.26	188.50
RTD23T4	✱	23.0	4.0	0.680	72.26	238.76
RTD23T5	✱	23.0	5.0	0.806	72.26	282.74
RTD23T8.6	✱	23.0	8.6	1.109	72.26	389.06
RTD23.9T1	✱	23.0	1.0	0.205	75.05	71.91

"✓" Stocked Item  
 "\*" Pre-order Only Item  
 (30-40 working days delivery)



# Round Tubes

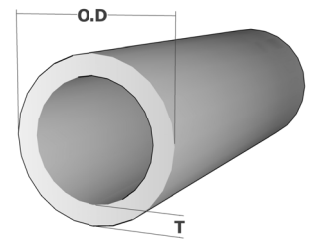

Product Code	Ex Stock	O.D (mm)	T (mm)	Mass (kg/m)	Perimeter (mm)	Area (mm <sup>2</sup> )
RTD24T1	*	24.0	1.0	0.206	75.40	72.26
RTD24T2	*	24.0	2.0	0.394	75.40	138.23
RTD24T2.5	*	24.0	2.5	0.481	75.40	168.86
RTD24T3	*	24.0	3.0	0.564	75.40	197.92
RTD24T4	*	24.0	4.0	0.716	75.40	251.33
RTD24T5	*	24.0	5.0	0.851	75.40	298.45
RTD24T6	*	24.0	6.0	0.967	75.40	339.30
RTD24T7	*	24.0	7.0	1.065	75.40	373.85
RTD24T9.1	*	24.0	9.1	1.214	75.40	426.00
RTD24.1T0.8	*	24.1	0.8	0.167	75.67	58.53
RTD24.5T2	*	24.5	2.0	0.403	76.97	141.37
RTD24.8T1.7	*	24.8	1.7	0.352	77.90	123.40
RTD24.8T1.9	*	24.8	1.9	0.389	77.87	136.62
RTD24.8T1.1	*	24.8	1.1	0.234	78.19	82.21
RTD24.9T1.2	*	24.9	1.2	0.255	78.19	89.30
RTD25T0.7	*	25.0	0.7	0.152	78.54	53.44
RTD25T0.8	*	25.0	0.8	0.173	78.50	60.79
RTD25T0.9	*	25.0	0.9	0.194	78.50	68.11
RTD25T1	*	25.0	1.0	0.215	78.50	75.36
RTD25T1.1	*	25.0	1.1	0.235	78.50	82.55
RTD25T1.2	*	25.0	1.2	0.256	78.50	89.68
RTD25T1.4	*	25.0	1.4	0.296	78.50	103.75
RTD25T1.5	*	25.0	1.5	0.315	78.50	110.69
RTD25T1.8	*	25.0	1.8	0.374	78.50	131.13
RTD25T1.9	✓	25.0	1.9	0.393	78.50	137.82
RTD25T2	*	25.0	2.0	0.412	78.54	144.51
RTD25T2.5	*	25.0	2.5	0.503	78.50	176.63
RTD25T3	✓	25.0	3.0	0.591	78.50	207.24
RTD25T4	*	25.0	4.0	0.752	78.54	263.90
RTD25T5	*	25.0	5.0	0.895	78.50	314.00
RTD25T5.5	*	25.0	5.5	0.960	78.54	336.94
RTD25T6	*	25.0	6.0	1.020	78.50	357.96
RTD25T7.3	*	25.0	7.3	1.156	78.50	405.72
RTD25T8.25	*	25.0	8.25	1.237	78.50	433.91
RTD25T9.1	*	25.0	9.1	1.295	78.50	454.33
RTD25T9.6	*	25.0	9.6	1.324	78.50	464.45
RTD25.4T1	*	25.4	1.0	0.218	79.76	76.62
RTD25.4T1.2	✓	25.4	1.2	0.260	79.76	91.19
RTD25.4T2.8	*	25.4	2.8	0.566	79.76	198.70
RTD25.5T1	*	25.5	1.0	0.219	80.11	77.00

"✓" Stocked Item  
 "✱" Pre-order Only Item  
 (30-40 working days delivery)



# Round Tubes

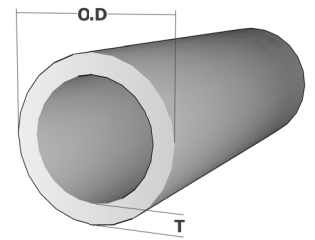

Product Code	Ex Stock	O.D (mm)	T (mm)	Mass (kg/m)	Perimeter (mm)	Area (mm <sup>2</sup> )
RTD25.5T2	✱	25.5	2.0	0.421	80.11	147.66
RTD25.6T1.4	✱	25.6	1.4	0.303	80.38	106.38
RTD25.9T1.3	✱	25.9	1.3	0.286	81.33	100.42
RTD26T1	✱	26.0	1.0	0.224	81.68	78.54
RTD26T2	✱	26.0	2.0	0.430	81.68	150.80
RTD26T3	✱	26.0	3.0	0.617	81.68	216.66
RTD26T4	✱	26.0	4.0	0.788	81.68	276.46
RTD26T5	✱	26.0	5.0	0.940	81.68	329.87
RTD26T7	✱	26.0	7.0	1.191	81.68	417.83
RTD26T8.7	✱	26.0	8.7	1.347	81.64	472.60
RTD26T10.1	✱	26.0	10.1	1.438	81.68	504.51
RTD26.2T1.7	✱	26.2	1.7	0.373	82.27	130.78
RTD26.3T2	✱	26.3	2.0	0.435	82.58	152.60
RTD27T0.7	✱	27.0	0.7	0.165	84.82	57.84
RTD27T1	✱	27.0	1.0	0.233	84.82	81.68
RTD27T1.2	✱	27.0	1.2	0.277	84.78	97.21
RTD27T2	✱	27.0	2.0	0.448	84.82	157.10
RTD27T2.2	✱	27.0	2.2	0.489	84.78	171.41
RTD27T3	✱	27.0	3.0	0.645	84.82	226.20
RTD27T4	✱	27.0	4.0	0.823	84.78	288.88
RTD27T5	✱	27.0	5.0	0.985	84.82	345.58
RTD27T10.6	✱	27.0	10.6	1.556	84.80	546.14
RTD27.2T4.5	✱	27.2	4.5	0.914	85.41	320.75
RTD27.5T1	✱	27.5	1.0	0.237	86.40	83.25
RTD27.5T2	✱	27.5	2.0	0.457	86.40	160.22
RTD27.6T1.3	✱	27.6	1.3	0.306	86.70	107.41
RTD27.8T1	✱	27.8	1.0	0.240	87.30	84.20
RTD27.9T0.55	✱	27.9	0.55	0.135	87.61	47.23
RTD28T0.8	✱	28.0	0.8	0.195	87.92	68.33
RTD28T1	✱	28.0	1.0	0.242	87.92	84.78
RTD28T1.1	✱	28.0	1.1	0.265	87.92	92.91
RTD28T1.5	✱	28.0	1.5	0.356	87.92	124.82
RTD28T1.8	✱	28.0	1.8	0.422	87.92	148.08
RTD28T2	✱	28.0	2.0	0.466	88.00	163.36
RTD28T2.2	✱	28.0	2.2	0.508	88.00	178.32
RTD28T3	✱	28.0	3.0	0.672	88.00	235.62
RTD28T3.2	✱	28.0	3.2	0.710	87.92	249.19
RTD28T4	✓	28.0	4.0	0.859	87.92	301.44
RTD28T5	✱	28.0	5.0	1.030	88.00	361.28
RTD28T6.9	✱	28.0	6.0	1.304	88.00	457.39



"✓" Stocked Item  
 "✱" Pre-order Only Item  
 (30-40 working days delivery)



# Round Tubes

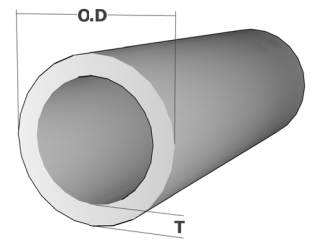

Product Code	Ex Stock	O.D (mm)	T (mm)	Mass (kg/m)	Perimeter (mm)	Area (mm <sup>2</sup> )
RTD28T11.1	✱	28.0	11.1	1.680	88.00	589.33
RTD28.3T1	✱	28.3	1.0	0.244	88.86	85.72
RTD28.5T2.2	✱	28.5	2.2	0.518	89.49	181.68
RTD28.6T0.8	✱	28.6	0.8	0.199	89.80	69.90
RTD28.7T2.5	✓	28.7	2.5	0.586	90.12	205.67
RTD29T0.75	✱	29.0	0.75	0.190	91.11	66.56
RTD29T1.1	✱	29.0	1.1	0.275	91.06	96.37
RTD29T2	✱	29.0	2.0	0.484	91.11	169.65
RTD29T3	✱	29.0	3.0	0.699	91.11	245.10
RTD29T4	✱	29.0	4.0	0.895	91.11	314.20
RTD29T5	✱	29.0	5.0	1.074	91.11	377.00
RTD29T11.6	✱	29.0	11.6	1.807	91.11	634.10
RTD29.4T1.7	✱	29.4	1.7	0.421	92.32	147.86
RTD29.8T1.9	✱	29.8	1.9	0.474	93.57	166.45
RTD30T1	✱	30.0	1.0	0.260	94.20	91.06
RTD30T1.25	✱	30.0	1.25	0.322	94.25	112.90
RTD30T1.5	✓	30.0	1.5	0.383	94.20	134.34
RTD30T2	✱	30.0	2.0	0.501	94.25	175.93
RTD30T3	✱	30.0	3.0	0.725	94.20	254.34
RTD30T4	✱	30.0	4.0	0.931	94.25	326.73
RTD30T5	✱	30.0	5.0	1.119	94.25	392.70
RTD30T12.1	✱	30.0	12.1	1.939	94.25	680.44
RTD30.5T2.5	✱	30.5	2.5	0.627	95.82	219.91
RTD31T2	✱	31.0	2.0	0.519	97.40	182.21
RTD31T3	✱	31.0	3.0	0.752	97.40	263.90
RTD31T3.25	✱	31.0	3.25	0.807	97.34	283.19
RTD31T4	✱	31.0	4.0	0.967	97.40	339.29
RTD31T5	✱	31.0	5.0	1.164	97.40	408.40
RTD31T12.6	✱	31.0	12.6	2.076	97.40	728.35
RTD31.5T2	✱	31.5	2.0	0.528	98.91	185.26
RTD31.5T3	✱	31.5	3.0	0.765	98.91	268.47
RTD31.6T1.8	✱	31.6	1.8	0.480	99.22	168.43
RTD31.8T1.1	✱	31.8	1.1	0.302	99.85	106.038
RTD31.8T2.9	✱	31.8	2.9	0.750	99.85	263.16
RTD31.8T3.15	✱	31.8	3.15	0.808	99.85	283.38
RTD32T0.8	✱	32.0	0.8	0.223	100.48	78.37
RTD32T1.2	✱	32.0	1.2	0.331	100.48	116.05
RTD32T1.4	✱	32.0	1.4	0.383	100.48	134.52
RTD32T1.5	✱	32.0	1.5	0.409	100.48	143.66
RTD32T1.6	✱	32.0	1.6	0.435	100.48	152.73

"✓" Stocked Item  
 "✱" Pre-order Only Item  
 (30-40 working days delivery)



# Round Tubes

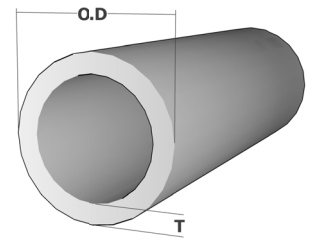

Product Code	Ex Stock	O.D (mm)	T (mm)	Mass (kg/m)	Perimeter (mm)	Area (mm <sup>2</sup> )
RTD32T2	✱	32.0	2.0	0.537	100.48	188.40
RTD32T2.5	✱	32.0	2.5	0.660	100.48	231.58
RTD32T3	✓	32.0	3.0	0.779	100.48	273.18
RTD32T3.2	✱	32.0	3.2	0.825	100.48	289.38
RTD32T4	✱	32.0	4.0	1.003	100.53	351.86
RTD32T5	✱	32.0	5.0	1.208	100.48	423.90
RTD32T7	✱	32.0	7.0	1.566	100.48	549.50
RTD32T8	✱	32.0	8.0	1.719	100.53	603.19
RTD32T13.1	✱	32.0	13.1	2.217	100.31	777.83
RTD32.6T1.2	✱	32.6	1.2	0.337	102.36	118.32
RTD33T2	✱	33.0	2.0	0.555	103.67	194.78
RTD33T3	✱	33.0	3.0	0.806	103.67	282.74
RTD33T4	✱	33.0	4.0	1.039	103.67	364.42
RTD33T5	✱	33.0	5.0	1.253	103.67	439.80
RTD33T13.6	✱	33.0	13.6	2.362	103.67	828.88
RTD33.8T4.8	✓	33.8	4.8	1.246	106.13	437.09
RTD34T1	✱	34.0	1.0	0.295	106.76	103.62
RTD34T1.8	✱	34.0	1.8	0.519	106.76	181.99
RTD34T2	✱	34.0	2.0	0.573	106.76	200.96
RTD34T2.5	✱	34.0	2.5	0.731	106.80	256.48
RTD34T3	✱	34.0	3.0	0.832	106.76	292.02
RTD34T4	✱	34.0	4.0	1.074	106.76	376.80
RTD34T5	✓	34.0	5.0	1.298	106.81	455.53
RTD35T0.55	✱	35.0	0.55	0.170	109.96	59.53
RTD35T0.6	✱	35.0	0.6	0.185	109.90	64.81
RTD35T0.75	✱	35.0	0.75	0.230	109.90	80.66
RTD35T1.1	✱	35.0	1.1	0.334	109.90	117.09
RTD35T1.5	✱	35.0	1.5	0.450	109.90	157.79
RTD35T1.8	✱	35.0	1.8	0.535	109.90	187.65
RTD35T2	✱	35.0	2.0	0.591	109.90	207.24
RTD35T4	✱	35.0	4.0	1.110	110.00	389.56
RTD35T5	✱	35.0	5.0	1.343	110.00	471.24
RTD35T6.5	✱	35.0	6.5	1.658	109.90	581.67
RTD35T12.3	✱	35.0	12.3	2.499	109.90	876.72
RTD35.2T0.8	✱	35.2	0.8	0.246	110.53	86.41
RTD35.4T1.4	✱	35.4	1.4	0.426	111.16	149.46
RTD35.5T0.8	✱	35.5	0.8	0.248	111.47	87.17
RTD35.5T0.9	✱	35.5	0.9	0.279	111.47	97.78
RTD35.5T1.2	✱	35.5	1.2	0.368	111.47	129.24
RTD35.8T2	✱	35.8	2.0	0.605	112.41	212.26

"✓" Stocked Item  
 "✱" Pre-order Only Item  
 (30-40 working days delivery)



# Round Tubes

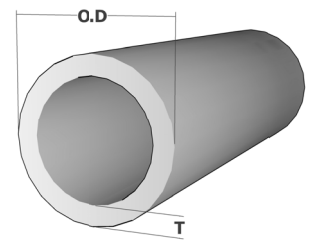

Product Code	Ex Stock	O.D (mm)	T (mm)	Mass (kg/m)	Perimeter (mm)	Area (mm <sup>2</sup> )
RTD36T0.8	✱	36.0	0.8	0.252	113.04	88.42
RTD36T1.2	✱	36.0	1.2	0.374	113.04	131.13
RTD36T1.25	✱	36.0	1.25	0.389	113.10	136.46
RTD36T2	✱	36.0	2.0	0.609	113.10	213.63
RTD36T4	✱	36.0	4.0	1.146	113.10	402.12
RTD36T5	✱	36.0	5.0	1.388	113.10	487.00
RTD36.5T8.75	✱	36.5	8.75	2.174	114.67	762.82
RTD36.7T1.1	✱	36.7	1.1	0.350	115.24	122.96
RTD37T13.4	✱	37.0	13.4	2.830	116.18	992.99
RTD37T5	✱	37.0	5.0	1.433	116.24	502.66
RTD38T1	✱	38.0	1.0	0.331	119.32	116.18
RTD38T1.1	✱	38.0	1.1	0.363	119.32	127.45
RTD38T1.4	✓	38.0	1.4	0.459	119.32	160.89
RTD38T1.8	✱	38.0	1.8	0.583	119.32	204.60
RTD38T2.5	✱	38.0	2.5	0.794	119.32	278.68
RTD38T2.9	✱	38.0	2.9	0.911	119.32	319.62
RTD38T3	✓	38.0	3.0	0.940	119.32	329.70
RTD38T3.5	✱	38.0	3.5	1.081	119.32	379.16
RTD38T8	✱	38.0	8.0	2.149	119.32	753.98
RTD38.1T3	✱	38.1	3.0	0.942	119.63	330.64
RTD38.4T1.1	✱	38.4	1.1	0.367	120.58	128.83
RTD39T1.05	✱	39.0	1.05	0.357	122.46	125.12
RTD39T4	✱	39.0	4.0	1.253	122.46	439.60
RTD39.12T1.36	✱	39.12	1.36	0.460	122.90	161.50
RTD40T0.9	✱	40.0	0.9	0.320	125.66	110.55
RTD40T1.05	✱	40.0	1.05	0.366	125.60	128.42
RTD40T1.25	✱	40.0	1.25	0.434	125.70	152.17
RTD40T1.5	✱	40.0	1.5	0.517	125.60	181.34
RTD40T2	✱	40.0	2.0	0.680	125.66	238.76
RTD40T3	✱	40.0	3.0	0.994	125.66	348.72
RTD40T4	✓	40.0	4.0	1.289	125.60	452.16
RTD40T5	✱	40.0	5.0	1.566	127.17	549.50
RTD40.5T0.8	✱	40.5	0.8	0.284	127.80	99.73
RTD40.7T0.75	✱	40.7	0.75	0.268	127.80	94.08
RTD41T0.8	✱	41.0	0.8	0.288	128.74	100.98
RTD41T0.9	✱	41.0	0.9	0.323	128.74	113.32
RTD41T1.2	✱	41.0	1.2	0.427	128.74	149.97
RTD41T1.5	✱	41.0	1.5	0.530	128.74	186.14
RTD41T4	✱	41.0	4.0	1.325	128.74	465.00
RTD41T5	✱	41.0	5.0	1.611	128.74	565.20

"✓" Stocked Item  
 "✱" Pre-order Only Item  
 (30-40 working days delivery)



# Round Tubes

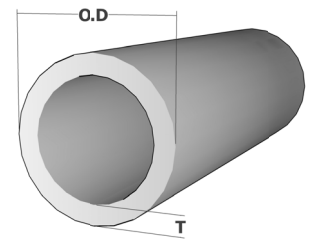

Product Code	Ex Stock	O.D (mm)	T (mm)	Mass (kg/m)	Perimeter (mm)	Area (mm <sup>2</sup> )
RTD41.8T0.8	✱	41.8	0.8	0.294	131.25	102.99
RTD41.8T2.8	✱	41.8	2.8	0.977	131.25	342.89
RTD42T1.1	✱	42.0	1.1	0.403	131.88	141.27
RTD42T1.2	✱	42.0	1.2	0.438	131.88	153.73
RTD42T1.4	✱	42.0	1.4	0.509	131.88	178.48
RTD42T9	✱	42.0	9.0	2.658	131.88	932.58
RTD43T1.5	✱	43.0	1.5	0.557	135.02	195.47
RTD43T2	✱	43.0	2.0	0.734	135.02	257.48
RTD43T2.5	✱	43.0	2.5	0.906	135.02	317.93
RTD43T3	✱	43.0	3.0	1.074	135.02	376.80
RTD43.3T2.8	✱	43.3	2.8	1.015	135.96	356.08
RTD43.5T0.6	✱	43.5	0.6	0.230	136.66	80.86
RTD44T1.25	✱	44.0	1.25	0.478	138.20	167.88
RTD44T3.2	✱	44.0	3.2	1.168	138.16	409.96
RTD45T1	✱	45.0	1.0	0.394	141.30	138.16
RTD45T1.15	✱	45.0	1.15	0.451	141.30	158.34
RTD45T1.35	✱	45.0	1.35	0.527	141.30	185.03
RTD45T1.6	✱	45.0	1.6	0.621	141.30	218.04
RTD45T3	✓	45.0	3.0	1.128	141.30	395.64
RTD47T5	✱	47.0	5.0	1.879	147.58	659.40
RTD48T1.25	✱	48.0	1.25	0.523	150.80	183.59
RTD48T1.5	✓	48.0	1.5	0.624	150.72	219.02
RTD48.4T2.6	✓	48.4	2.6	1.066	151.98	373.91
RTD49.5T0.8	✱	49.5	0.8	0.349	155.43	122.33
RTD49.5T1.4	✱	49.5	1.4	0.603	155.43	211.45
RTD49.5T1.5	✱	49.5	1.5	0.644	155.43	226.08
RTD49.7T3	✓	49.7	3.0	1.254	156.06	439.91
RTD49.8T1.9	✓	49.8	1.9	0.814	156.37	285.77
RTD50T1	✱	50.0	1.0	0.439	157.00	153.86
RTD50T1.2	✱	50.0	1.2	0.524	157.00	183.88
RTD50T1.4	✱	50.0	1.4	0.609	157.00	213.65
RTD50T1.5	✱	50.0	1.5	0.651	157.00	228.44
RTD50T2.5	✱	50.0	2.5	1.063	157.00	372.88
RTD50T2.7	✱	50.0	2.7	1.143	157.00	401.01
RTD50T2.8	✱	50.0	2.8	1.183	157.00	414.98
RTD50T3	✓	50.0	3.0	1.262	157.00	442.74
RTD50T3.5	✱	50.0	3.5	1.456	157.00	551.04
RTD50T3.8	✱	50.0	3.8	1.571	157.00	551.26
RTD50T4	✓	50.0	4.0	1.647	157.00	577.76
RTD50T5	✱	50.0	5.0	2.014	157.00	706.50

"✓" Stocked Item  
 "✱" Pre-order Only Item  
 (30-40 working days delivery)



# Round Tubes

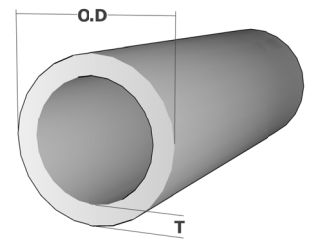

Product Code	Ex Stock	O.D (mm)	T (mm)	Mass (kg/m)	Perimeter (mm)	Area (mm <sup>2</sup> )
RTD50T5.5	*	50.0	5.5	2.190	157.00	768.52
RTD50T9.7	*	50.0	9.7	3.498	157.00	1227.46
RTD50.8T3.0	*	50.8	3.0	1.284	159.59	450.50
RTD51.5T2.5	*	51.5	2.5	1.097	161.79	384.85
RTD52T1.25	*	52.0	1.25	0.568	163.40	199.29
RTD53.8T0.6	*	53.8	0.6	0.286	169.00	100.28
RTD54T0.7	*	54.0	0.7	0.334	169.56	117.15
RTD54.5T3.2	*	54.5	3.2	1.469	171.13	515.46
RTD56T1.25	*	56.0	1.25	0.613	175.90	215.00
RTD56T15.5	*	56.0	15.5	5.621	175.93	1972.14
RTD57T4	✓	57.0	4.0	1.897	178.98	665.68
RTD57.5T3	*	57.5	3.0	1.464	180.64	513.65
RTD59.7T3	*	59.7	3.0	1.522	187.46	534.11
RTD60T1.25	*	60.0	1.25	0.658	188.50	230.71
RTD60T1.5	*	60.0	1.5	0.785	188.40	275.54
RTD60T5	*	60.0	5.0	2.461	188.40	863.50
RTD60T9	*	60.0	9.0	4.110	188.50	1442.00
RTD60.9T8	*	60.9	8.0	3.789	190.32	1329.52
RTD63T1.5	*	63.0	1.5	0.826	197.82	289.67
RTD63T6.5	*	63.0	6.5	3.288	197.92	1153.75
RTD63.5T3	*	63.5	3.0	1.625	199.49	570.20
RTD64T0.8	*	64.0	0.8	0.452	200.96	158.76
RTD64T1.25	*	64.0	1.25	0.702	201.10	246.42
RTD67.4T0.7	*	67.4	0.7	0.418	211.74	146.68
RTD68T1.25	*	68.0	1.25	0.747	213.60	262.13
RTD70T2	*	70.0	2.0	1.217	219.80	427.04
RTD70T4	*	70.0	4.0	2.363	219.80	828.96
RTD72T0.8	*	72.0	0.8	0.510	226.08	178.85
RTD72T1.25	*	72.0	1.25	0.792	226.20	277.83
RTD75T1.8	*	75.0	1.8	1.180	235.60	413.90
RTD75T3	✓	75.0	3.0	1.933	235.50	678.24
RTD76T0.61	*	76.0	0.61	0.412	238.76	144.48
RTD76T0.72	*	76.0	0.72	0.485	238.76	170.28
RTD76T0.77	*	76.0	0.77	0.519	238.76	181.98
RTD76T0.8	*	76.0	0.8	0.538	238.64	188.90
RTD76T0.9	*	76.0	0.9	0.605	238.64	212.23
RTD76T1	*	76.0	1.0	0.671	238.64	235.50
RTD76T1.2	*	76.0	1.2	0.803	238.64	281.85
RTD76T1.4	*	76.0	1.4	0.935	238.64	327.94
RTD76T1.5	*	76.0	1.5	1.000	238.64	350.90

"✓" Stocked Item  
 "✱" Pre-order Only Item  
 (30-40 working days delivery)



# Round Tubes

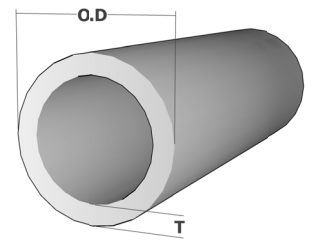

Product Code	Ex Stock	O.D (mm)	T (mm)	Mass (kg/m)	Perimeter (mm)	Area (mm <sup>2</sup> )
RTD76T4	✓	76.0	4.0	2.577	238.64	904.32
RTD76T5	✱	76.0	5.0	3.179	238.64	1115.27
RTD76.2T1.3	✱	76.2	1.3	0.872	239.40	305.90
RTD80T10	✱	80.0	10.0	6.267	251.33	2199.11
RTD80T12.5	✱	80.0	12.5	7.555	251.33	2650.72
RTD80T15	✱	80.0	15.0	8.730	251.33	3063.05
RTD80T22.5	✱	80.0	22.5	11.584	251.33	4064.44
RTD80.4T1.3	✱	80.4	1.3	0.921	252.60	323.05
RTD80.6T0.8	✱	80.6	0.8	0.572	253.21	200.56
RTD84.8T1.3	✱	84.8	1.3	0.972	266.40	341.02
RTD85T12.5	✱	85.0	12.5	8.114	267.04	2847.07
RTD85T15	✱	85.0	15.0	9.401	267.04	3298.67
RTD85T17.5	✱	85.0	17.5	10.576	267.04	3711.01
RTD85T25	✱	85.0	25.0	13.430	267.04	4712.39
RTD88.9T5.3	✱	88.9	5.3	3.967	279.46	1391.98
RTD89T4	✓	89.0	4.0	3.043	279.46	1067.60
RTD89T5	✱	89.0	5.0	3.760	279.46	1319.47
RTD89.6T1.5	✱	89.6	1.5	1.183	281.50	415.16
RTD90T2	✱	90.0	2.0	1.575	282.60	552.64
RTD90T15	✱	90.0	15.0	10.073	282.74	3534.29
RTD90T17.5	✱	90.0	17.5	11.360	282.74	3985.90
RTD90T20	✱	90.0	20.0	12.535	282.74	4398.23
RTD90T27.5	✱	90.0	27.5	15.389	282.74	5399.61
RTD94T1.5	✱	94.0	1.5	1.242	295.31	435.90
RTD95T0.8	✱	95.0	0.8	0.674	298.30	236.63
RTD95T17.5	✱	95.0	17.5	12.143	298.45	4260.47
RTD95T20	✱	95.0	20.0	13.430	298.45	4712.39
RTD95T22.5	✱	95.0	22.5	14.605	298.45	5124.72
RTD95T30	✱	95.0	30.0	17.459	298.45	6126.11
RTD97T1	✱	97.0	1.0	0.860	304.74	301.59
RTD97T1.1	✱	97.0	1.1	0.944	304.58	331.24
RTD100T4	✓	100.0	4.0	3.436	314.00	1205.76
RTD100T5	✱	100.0	5.0	4.251	314.00	1491.50
RTD100T10	✱	100.0	10.0	8.058	314.16	2827.43
RTD100T20	✱	100.0	20.0	14.326	314.16	5026.55
RTD100T22.5	✱	100.0	22.5	15.613	314.16	5478.15
RTD100T25	✱	100.0	25.0	16.788	314.16	5890.49
RTD100T32.5	✱	100.0	32.5	19.642	314.16	6891.87
RTD102T0.9	✱	102.0	0.9	0.814	320.28	285.71
RTD102T1	✱	102.0	1.0	0.904	320.28	317.14

"✓" Stocked Item  
 "\*" Pre-order Only Item  
 (30-40 working days delivery)



# Round Tubes

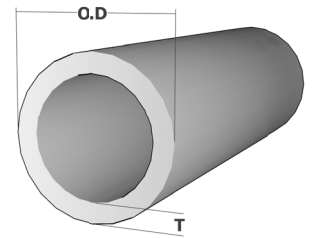

Product Code	Ex Stock	O.D (mm)	T (mm)	Mass (kg/m)	Perimeter (mm)	Area (mm <sup>2</sup> )
RTD102T2	*	102.0	2.0	1.790	320.28	628.00
RTD102T3	*	102.0	3.0	2.659	320.28	933.05
RTD108T5	*	108.0	5.0	4.609	339.12	1617.10
RTD110T10	*	110.0	10.0	8.954	345.57	3141.59
RTD110T15	*	110.0	15.0	12.759	345.58	4476.77
RTD110T25	*	110.0	25.0	19.026	345.58	6675.88
RTD110T27.5	*	110.0	27.5	20.313	345.58	7127.49
RTD110T30	*	110.0	30.0	21.488	345.58	7539.82
RTD110T37.5	*	110.0	37.5	24.342	345.58	8541.24
RTD114.3T2.8	*	114.3	2.8	2.789	359.10	978.76
RTD115.8T1.9	*	115.8	1.9	1.938	363.80	679.87
RTD117.9T1.2	*	117.9	1.2	1.254	370.40	439.95
RTD120T2.5	*	120.0	2.5	2.629	376.80	922.38
RTD120T4	✓	120.0	4.0	4.152	376.80	1456.96
RTD120T10	*	120.0	10.0	9.849	376.80	3455.75
RTD120T15	*	120.0	15.0	14.102	377.00	4948.00
RTD120T20	*	120.0	20.0	17.907	377.00	6283.19
RTD120T30	*	120.0	30.0	24.175	377.00	8482.30
RTD120T32.5	*	120.0	32.5	25.462	377.00	8933.90
RTD120T35	*	120.0	35.0	26.637	377.00	9346.23
RTD120T42.5	*	120.0	42.5	29.491	377.00	10347.62
RTD127T2	✓	127.0	2.0	2.237	398.78	785.00
RTD130T10	*	130.0	10.0	10.744	408.41	3769.91
RTD130T15	*	130.0	15.0	15.445	408.41	5419.25
RTD130T20	*	130.0	20.0	19.698	408.41	6911.50
RTD130T25	*	130.0	25.0	23.503	408.41	8246.68
RTD130T35	*	130.0	35.0	29.771	408.41	10445.80
RTD130T37.5	*	130.0	37.5	31.058	408.41	10897.40
RTD130T40	*	130.0	40.0	32.233	408.41	11309.73
RTD130T47.5	*	130.0	47.5	35.087	408.41	12311.12
RTD133T5	✓	133.0	5.0	5.727	417.62	2009.60
RTD134T1.4	*	134.0	1.4	1.661	420.76	582.91
RTD134T2.4	*	134.0	2.4	2.826	420.76	991.74
RTD140T15	*	140.0	15.0	16.788	439.82	5890.49
RTD140T20	*	140.0	20.0	21.488	439.82	7539.82
RTD140T25	*	140.0	25.0	25.741	439.82	9032.10
RTD140T30	*	140.0	30.0	29.547	439.82	10367.26
RTD140T40	*	140.0	40.0	35.814	439.82	12566.37
RTD140T42.5	*	140.0	42.5	37.101	439.82	13017.97
RTD140T45	*	140.0	45.0	38.276	439.82	13430.31



"✓" Stocked Item  
 "✱" Pre-order Only Item  
 (30-40 working days delivery)



# Round Tubes

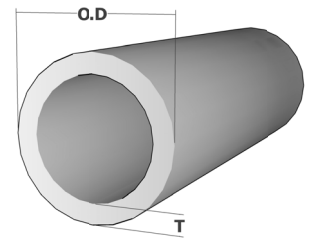

Product Code	Ex Stock	O.D (mm)	T (mm)	Mass (kg/m)	Perimeter (mm)	Area (mm <sup>2</sup> )
RTD140T52.5	✱	140.0	52.5	41.130	439.82	14431.69
RTD141T45	✱	141.0	2.0	2.489	443.00	873.36
RTD150T2	✱	150.0	2.0	2.649	471.24	929.44
RTD150T5	✓	150.0	5.0	6.488	471.24	2276.50
RTD150T10	✱	150.0	10.0	12.535	471.24	4398.23
RTD150T15	✱	150.0	15.0	18.131	471.24	6361.73
RTD150T20	✱	150.0	20.0	23.279	471.24	8168.14
RTD150T25	✱	150.0	25.0	27.980	471.24	9817.48
RTD150T30	✱	150.0	30.0	32.233	471.24	11309.73
RTD150T40	✱	150.0	40.0	39.396	471.24	13823.01
RTD159T6	✓	159.0	6.0	8.215	499.26	2882.52
RTD160T10	✱	160.0	10.0	13.430	502.65	4712.39
RTD160T15	✱	160.0	15.0	19.474	502.65	6832.96
RTD160T20	✱	160.0	20.0	25.070	502.65	8796.46
RTD160T25	✱	160.0	25.0	30.218	502.65	10602.88
RTD160T30	✱	160.0	30.0	34.919	502.65	12252.21
RTD160T35	✱	160.0	35.0	39.172	502.65	13744.47
RTD160T45	✱	160.0	45.0	46.335	502.65	16257.74
RTD162.5T38.5	✱	162.5	38.5	42.744	510.51	14997.96
RTD170T10	✱	170.0	10.0	14.326	534.07	5026.55
RTD170T15	✱	170.0	15.0	20.817	534.07	7304.20
RTD170T20	✱	170.0	20.0	26.861	534.07	9424.78
RTD170T25	✱	170.0	25.0	32.457	534.07	11388.27
RTD170T30	✱	170.0	30.0	37.605	534.07	13194.69
RTD170T35	✱	170.0	35.0	42.305	534.07	14844.03
RTD170T40	✱	170.0	40.0	46.558	534.07	16336.28
RTD170T50	✱	170.0	50.0	53.721	534.07	18849.56
RTD170.4T1.7	✱	170.4	1.7	2.568	535.33	900.98
RTD180T10	✱	180.0	10.0	15.221	565.49	5340.71
RTD180T12.5	✱	180.0	12.5	18.746	565.49	6577.71
RTD180T20	✱	180.0	20.0	28.651	565.49	10053.10
RTD180T25	✱	180.0	25.0	34.695	565.49	12173.67
RTD180T30	✱	180.0	30.0	40.291	565.49	14137.17
RTD180T35	✱	180.0	35.0	45.439	565.49	15943.58
RTD180T40	✱	180.0	40.0	50.140	565.49	17592.92
RTD180T45	✱	180.0	45.0	54.393	565.49	19085.18
RTD180T55	✱	180.0	55.0	61.556	565.49	21598.45
RTD182T15	✱	182.0	15.0	22.429	571.77	7869.69
RTD185T12.5	✱	185.0	12.5	19.306	581.20	6774.06
RTD185T15	✱	185.0	15.0	22.832	581.20	8011.06





"✓" Stocked Item  
 "✱" Pre-order Only Item  
 (30-40 working days delivery)



# Equal Angles

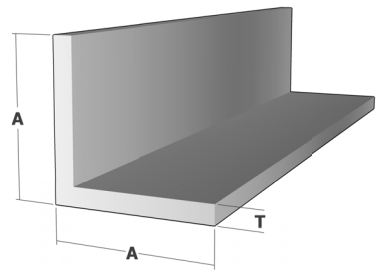

Product Code	Ex Stock	A (mm)	T (mm)	Mass (kg/m)	Perimeter (mm)	Area (mm <sup>2</sup> )
EAA9T0.6	*	9.0	0.6	0.030	36.00	10.40
EAA11T1.2	*	11.0	1.2	0.073	44.00	25.64
EAA12T1.2	*	12.0	1.2	0.078	48.00	27.36
EAA12T1.6	✓	12.0	1.6	0.102	47.00	35.70
EAA12T3	✓	12.0	3.0	0.179	47.00	62.92
EAA12.5T0.6	*	12.5	0.6	0.042	50.00	14.60
EASA15T1.2	✓	15.0	1.2	0.097	60.00	34.12
EAA16 T1.5	✓	16.0	1.5	0.130	63.00	45.60
EAA19T0.65	*	19.0	0.65	0.069	76.00	24.20
EASA19T1.5	✓	19.0	1.5	0.155	76.00	54.30
EAA19T1.9	✓	19.0	1.9	0.195	76.00	68.50
EAA20T0.8	*	20.0	0.8	0.089	80.00	31.22
EAA20T1.5	*	20.0	1.5	0.163	80.00	57.27
EAA20T1.6	✓	20.0	1.6	0.175	80.00	61.44
EASA20T3	✓	20.0	3.0	0.322	77.00	113.14
EAA22T1.1	✓	22.0	1.1	0.135	64.60	73.00
EASA25T1.5	✓	25.0	1.5	0.100	79.70	35.20
EAA25T2.5	✓	25.0	2.5	0.217	79.50	76.00
EAA25T3	✓	25.0	3.0	0.496	76.60	174.20
EAA25.4T0.65	*	25.4	0.65	0.245	89.50	86.00
EAA25.4T1.9	*	25.4	1.9	0.153	70.00	53.76
EASA29.5T3	*	29.5	3.0	0.473	118.00	166.00
EAA30T1	*	30.0	1.0	0.168	120.00	58.90
EAA30T1.5	✓	30.0	1.5	0.250	119.23	87.67
EAA30T2.0	*	30.0	2.0	0.331	120.00	116.00
EAA30T2.5	*	30.0	2.5	0.409	120.00	143.35
EAA30T3	✓	30.0	3.0	0.487	120.00	171.00
EAA30T4	✓	30.0	4.0	0.638	120.00	223.70
EAA30T4.5	*	30.0	4.5	0.712	119.00	249.67
EAA30T5.5	*	30.0	5.5	0.854	119.00	299.67
EAA35T1.5	*	35.0	1.5	0.293	140.00	102.75
EAA37.8T1.8	*	37.8	1.8	0.378	151.00	132.80
EASA38T1.5	✓	38.0	1.5	0.317	152.00	111.30
EAA38T3	*	38.0	3.0	0.624	152.00	218.92
EAA40T1.6	*	40.0	1.6	0.357	159.00	125.36
EAA40T2	*	40.0	2.0	0.445	160.00	156.00
EAA40T3	✓	40.0	3.0	0.658	160.00	231.00
EAA40T4	*	40.0	4.0	0.866	160.00	304.00
EASA40T7	*	40.0	7.0	1.448	159.00	508.23
EAA50T1.6	*	50.0	1.6	0.449	200.00	157.44



"✓" Stocked Item

"✳" Pre-order Only Item  
(30-40 working days delivery)



# Unequal Angles

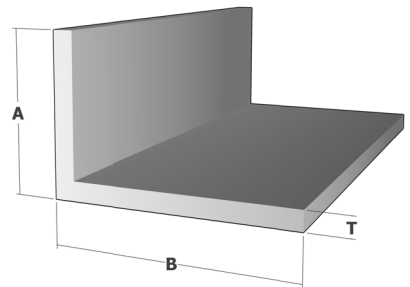

Product Code	Ex Stock	A (mm)	B (mm)	T (mm)	Mass (kg/m)	Perimeter (mm)	Area (mm <sup>2</sup> )
UAA10B5T1	*	10.0	5.0	1.0	0.040	29.23	13.92
UAA15B10T1	*	15.0	10.0	1.0	0.068	50.00	24.00
UAA18B10T1	✓	18.0	10.0	1.0	0.077	56.00	27.00
UAA19B8T1.5	*	19.0	8.0	1.5	0.105	52.98	36.82
UAA20B11T1.5	*	20.0	11.0	1.5	0.126	62.00	44.25
UAA20B11.5T2	*	20.0	11.5	2.0	0.167	91.93	58.73
UAA20B12T1.6	✓	20.0	12.0	1.6	0.138	62.70	48.50
UAA20B12T3	✓	20.0	12.0	3.0	0.248	63.23	86.92
UAA20B14T2	*	20.0	14.0	2.0	0.182	68.00	64.00
UAA20.3B7.1T1.1	*	20.3	7.1	1.1	0.082	54.16	28.83
UAA21B20T2	*	21.0	20.0	2.0	0.220	81.14	77.20
UAA21.2B13.7T1.2	*	21.2	13.7	1.2	0.115	69.40	40.30
UAA21.6B7.8T1.6	*	21.6	7.8	1.6	0.125	57.17	43.93
UAA24B16T1.5	*	24.0	16.0	1.5	0.165	80.00	57.75
UAA25B12T1.6	✓	25.0	12.0	1.6	0.161	74.00	56.64
UAA25B12.4T2	*	25.0	12.4	2.0	0.201	73.50	70.60
UAA25B20T1.6	✓	25.0	20.0	1.6	0.198	88.70	69.30
UAA25B20T2	*	25.0	20.0	2.0	0.245	90.00	86.00
UAA25B20T3	*	25.0	20.0	3.0	0.359	90.00	126.00
UASA29.2B17.3T2.8	*	29.2	17.3	2.8	0.307	92.20	107.80
UASA30B8.5T1.5	*	30.0	8.5	1.5	0.148	77.00	51.95
UAA30B17T2	*	30.0	17.0	2.0	0.257	100.00	96.00
UAA30B20T1.7	*	30.0	20.0	1.7	0.274	99.00	118.67
UAA30B20T2.5	✓	30.0	20.0	2.5	0.338	99.00	118.67
UAA30B25T2	✓	30.0	25.0	2.0	0.302	110.00	106.00
UAA30B25T4	*	30.0	25.0	4.0	0.581	109.23	203.92
UAA30B26T6	*	30.0	26.0	6.0	0.857	112.00	300.80
UASA33.5B25T3	✓	33.5	25.0	3.0	0.472	117.00	165.60
UAA38B11T1	*	38.0	11.0	1.0	0.137	98.00	48.00
UAA38.5B26.5T4	*	38.5	26.5	4.0	0.695	130.00	244.00
UAA38.5B26.5T8	*	38.5	26.5	8.0	1.300	130.00	456.00
UASA40B12T3	*	40.0	12.0	3.0	0.419	104.00	147.00
UASA40B17T2	*	40.0	17.0	2.0	0.314	114.00	110.00
UASA40B20T2	*	40.0	20.0	2.0	0.331	120.00	116.00
UASA40B25T1.5	*	40.0	25.0	1.5	0.271	130.00	95.25
UASA40B25T3	✓	40.0	25.0	3.0	0.530	130.00	186.00
UAA40B25T2	*	40.0	25.0	2.0	0.358	130.00	125.60
UASA41B26T6	*	41.0	26.0	6.0	1.045	134.00	366.80
UASA42B22T2	*	42.0	22.0	2.0	0.351	125.85	123.00
UAA44B30T3	✓	44.0	30.0	3.0	0.627	148.00	219.90

"✓" Stocked Item  
 "✱" Pre-order Only Item  
 (30-40 working days delivery)



# Unequal Angles

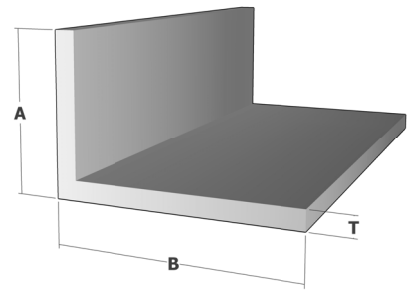

Product Code	Ex Stock	A (mm)	B (mm)	T (mm)	Mass (kg/m)	Perimeter (mm)	Area (mm <sup>2</sup> )
UAA45B8T1.2	✱	45.0	8.0	1.2	0.177	106.00	62.10
UAA45B10T1	✱	45.0	10.0	1.0	0.154	110.00	54.00
UAA45B35T3	✱	45.0	35.0	3.0	0.658	160.00	231.00
UAA50B20T1.6	✱	50.0	20.0	1.6	0.312	140.00	109.44
UAA50B20T3	✓	50.0	20.0	3.0	0.573	140.00	201.00
UAA50B25T1.5	✓	50.0	25.0	1.5	0.314	148.70	110.00
UAA50B25T3	✓	50.0	25.0	3.0	0.615	148.70	215.80
UAA50B30T1.5	✱	50.0	30.0	1.5	0.355	159.23	117.67
UAA50B30T4	✱	50.0	30.0	4.0	0.866	160.00	304.00
UAA50B28T4	✱	50.0	28.0	4.0	1.448	156.00	296.00
UAA50B40T3	✱	50.0	40.0	3.0	0.829	180.00	261.00
UAA52B20T2	✱	52.0	20.0	2.0	0.399	144.00	140.00
UAA52B30T2	✱	52.0	30.0	2.0	0.456	164.00	160.00
UAA52B40T22	✱	52.0	40.0	22.0	1.094	184.00	1540.00
UAA55B40T4	✓	55.0	40.0	4.0	1.037	190.00	363.93
UAA60B25T3	✓	60.0	25.0	3.0	0.701	168.70	245.80
UAA60B25T4	✱	60.0	25.0	4.0	0.923	169.23	323.93
UAA60B30T2	✱	60.0	30.0	2.0	0.502	180.00	176.00
UASA60B40T10	✱	60.0	40.0	10.0	2.567	196..57	900.86
UAA60B50T4.7	✱	60.0	50.0	4.7	1.410	220.00	494.80
UAA62B32T3	✱	62.0	32.0	2.0	0.524	188.00	184.00
UAA63B25T3	✱	63.0	25.0	3.0	0.726	176.33	254.84
UAA64B25T10	✱	64.0	25.0	10.0	2.394	172.96	840.00
UAA64B25T10	✱	64.0	25.0	10.0	2.394	172.96	840.00
UAA64B25T10	✱	64.0	25.0	10.0	2.468	172.68	865.88
UAA65B25T10	✱	65.0	25.0	10.0	2.417	174.71	847.99
UAA70B25T1.5	✱	70.0	25.0	1.5	0.400	190.00	140.25
UAA70B35T3	✱	70.0	35.0	3.0	0.881	205.92	309.17
UAA70B40T5	✓	70.0	40.0	5.0	1.494	220.00	524.10
UAA70B50T4.7	✓	70.0	50.0	4.7	1.544	240.00	541.80
UAA75B25T1.5	✱	75.0	25.0	1.5	0.421	200.00	147.75
UAA75B25T3	✓	75.0	25.0	3.0	0.829	198.70	290.80
UAA75B50T3	✓	75.0	50.0	3.0	1.043	250.00	366.00
UAA75B50T6	✓	75.0	50.0	6.0	2.035	250.00	714.00
UASA80B40T10	✱	80.0	40.0	10.0	3.137	236.57	1100.86
UASA80B50T2	✱	80.0	50.0	2.0	0.730	257.94	255.97
UAA80B50T4.7	✱	80.0	50.0	4.7	1.678	260.00	588.80
UAA90B80T10.4	✱	90.0	80.0	10.4	4.730	339.23	1659.80
UAA100B25T3	✓	100.0	25.0	3.0	1.043	248.70	365.80
UAA100B50T4	✓	100.0	50.0	4.0	1.664	300.00	584.00

"✓" Stocked Item  
 "✱" Pre-order Only Item  
 (30-40 working days delivery)



# Unequal Angles

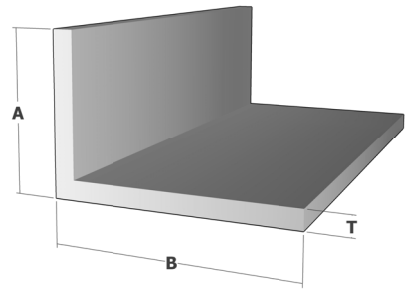

Product Code	Ex Stock	A (mm)	B (mm)	T (mm)	Mass (kg/m)	Perimeter (mm)	Area (mm <sup>2</sup> )
UAA100B50T5	✱	100.0	50.0	5.0	2.066	299.30	725.00
UAA100B50T6	✓	100.0	50.0	6.0	2.462	299.23	863.92
UAA100B50T8	✱	100.0	50.0	8.0	3.237	300.00	1135.92
UAA100B65T6	✱	100.0	65.0	6.0	2.718	328.70	953.80
UAA100B75T8	✓	100.0	75.0	8.0	3.808	350.00	1336.00
UAA110B25T10	✱	110.0	25.0	10.0	3.563	270.00	1250.00
UASA110B70T12	✱	110.0	70.0	12.0	4.628	360.00	1624.00
UAA125B40T6	✓	125.0	50.0	8.0	3.808	350.00	1336.00
UAA130B30T1.8	✱	130.0	30.0	1.8	0.811	319.23	284.68
UAA130B50T2	✱	130.0	50.0	2.0	1.014	359.23	355.92
UAA150B50T2.5	✱	150.0	50.0	2.5	1.407	400.00	493.75
UAA150B75T6	✓	150.0	75.0	6.0	3.745	450.00	1314.00
UAA150B75T10	✱	150.0	75.0	10.0	6.127	449.23	2149.92
UAA150B100T8	✱	150.0	100.0	8.0	5.518	500.00	1936.00
UAA150B120T10	✱	150.0	120.0	10.0	7.410	540.00	2600.00
UAA200B75T10	✓	200.0	75.0	8.0	6.088	550.00	2136.00
UAA200B100T10	✓	200.0	100.0	10.0	8.265	599.23	2899.92

"✓" Stocked Item  
 "✱" Pre-order Only Item  
 (30-40 working days delivery)



# U Channels

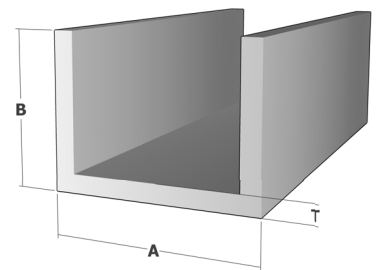

Product Code	Ex Stock	A (mm)	B (mm)	T (mm)	Mass (kg/m)	Perimeter (mm)	Area (mm <sup>2</sup> )
CLA4.3B8T0.6	✓	4.3	8.0	0.6	0.032	38.37	11.38
CLSA5.4B22T1.5	✱	5.4	11.0	1.5	0.103	50.20	36.13
CLA7.2B9.9T1.3	✱	7.2	9.9	1.3	0.087	51.72	30.40
CLA8B9.3T0.65	✓	8.0	9.3	0.65	0.047	50.83	16.35
CLA8.7B9T0.6	✱	8.7	9.0	0.6	0.043	51.20	15.22
CLSA8.84B5T2	✱	8.84	5.0	2.0	0.070	32.48	24.53
CLA10B10T1.5	✓	10.0	10.0	1.5	0.115	56.00	40.42
CLA10B15T1.4	✱	10.0	15.0	1.4	0.148	77.2	52.08
CLA10.3B15T1.5	✱	10.3	15.0	1.5	0.159	77.6	55.95
CLA12B12T1.5	✓	12.0	12.0	1.5	0.141	68.00	49.42
CLA12B4T2	✱	12.0	4.0	2.0	0.091	36.00	32.00
CLA12B12T0.5	✱	12.0	12.0	0.5	0.045	70.20	15.75
CLA13B20T1.25	✱	13.0	20.0	1.25	0.180	103.50	63.13
CLA15.6B20T1.5	✱	15.6	20.0	1.5	0.225	108.20	78.90
CLA16B16T1.6	✓	16.0	16.0	1.6	0.204	91.10	71.50
CLA16B30T1.5	✱	16.0	30.0	1.5	0.312	149.00	109.50
CLA16B60T4.0	✱	16.0	60.0	4.0	1.479	253.88	518.87
CLA18B12T0.5	✱	18.0	12.0	0.5	0.053	82.20	18.45
CLSA19B13T0.5	✱	19.0	13.0	1.0	0.063	46.25	22.27
CLA19B13T0.5	✱	19.0	13.0	0.5	0.063	89.00	22.00
CLA19.6B19.6T1.3	✓	19.6	19.6	1.3	0.207	113.40	72.70
CLA20B10T1.5	✱	20.0	10.0	1.5	0.158	77.00	55.50
CLA20B20T3	✓	20.0	20.0	3.0	0.461	112.30	161.80
CLSA20B25T2.6	✓	20.0	25.0	2.6	0.497	133.00	174.30
CLSA21B21T1.5	✱	21.0	21.0	1.5	0.257	123.00	90.00
CLSA22B22T3	✓	22.0	22.0	3.0	0.513	434.13	179.92
CLSA22B60T3	✱	22.0	60.0	3.0	1.251	271.20	438.80
CLSA22.5B35T3.5	✓	22.5	35.0	3.5	0.860	174.00	301.80
CLA23B20T2	✱	23.0	20.0	2.0	0.107	40.84	37.70
CLA23B15T1	✓	23.0	15.0	1.0	0.145	102.80	51.00
CLA24B7.5T2.4	✱	24.0	7.5	2.4	0.234	72.20	82.00
CLSA24B12T1	✱	24.0	12.0	1.0	0.130	92.73	45.72
CLA25B20T1	✱	25.0	20.0	1.0	0.179	127.00	62.92
CLA25B25T3	✓	25.0	25.0	3.0	0.590	143.00	207.00
CLA25B25T1.9	✓	25.0	25.0	1.9	0.385	147.00	135.20
CLA25B50T3	✓	25.0	50.0	3.0	1.017	243.00	357.00
CLA25.5B12.8T1	✱	25.5	12.8	1.0	0.140	99.17	49.02
CLSA26B15.5T0.7	✱	26.0	15.5	0.7	0.112	111.40	39.34
CLSA28.8B35T3.5	✓	28.8	35.0	3.5	0.932	187.00	327.00
CLA30B10T2	✱	30.0	10.0	2.0	0.262	96.00	92.00

"✓" Stocked Item  
 "✱" Pre-order Only Item  
 (30-40 working days delivery)



# U Channels

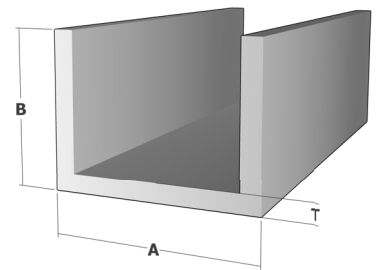

Product Code	Ex Stock	A (mm)	B (mm)	T (mm)	Mass (kg/m)	Perimeter (mm)	Area (mm <sup>2</sup> )
CLA30B17T1.2	✱	30.0	17.0	1.2	0.239	124.60	84.00
CLA30B20T1	✱	30.0	20.0	1.0	0.194	137.00	67.92
CLA35B7.5T2.4	✱	35.0	7.5	2.4	0.309	94.20	108.40
CLSA35B9.5T3.3	✱	35.0	9.5	3.3	0.512	100.00	179.70
CLA35B13T2	✱	35.0	13.0	2.0	0.325	118.00	114.00
CLSA35B15T4	✱	35.0	15.0	4.0	0.726	117.43	254.79
CLA35.5B17T3	✱	35.5	17.0	3.0	0.543	131.87	190.42
CLA36B36T2.5	✓	36.0	36.0	2.5	0.733	209.30	257.30
CLSA36.2B11.9T2	✱	36.2	11.9	2.0	0.319	115.20	111.92
CLA38.2B12.8T1	✱	38.2	12.8	1.0	0.177	124.20	62.00
CLA40B11.5T2	✱	40.0	11.5	2.0	0.335	120.71	117.68
CLA40B15T3	✓	40.0	15.0	3.0	0.547	132.28	191.79
CLSA40B19T4	✱	40.0	19.0	4.0	0.787	144.14	276.03
CLA40B20T1.6	✱	40.0	20.0	1.6	0.350	155.77	122.80
CLA40B25T3	✓	40.0	25.0	3.0	0.718	172.30	251.80
CLSA41B45T3	✱	41.0	45.0	3.0	1.035	252.65	363.00
CLA44B50T4	✓	44.0	50.0	4.0	1.550	278.30	543.80
CLA44B50T6	✱	44.0	50.0	6.0	2.230	270.94	782.57
CLA45B8T1.2	✱	45.0	8.0	1.2	0.200	118.60	70.20
CLA45.5B27T5	✱	45.5	27.0	5.0	1.275	188.00	447.42
CLA46B20T2	✱	46.0	20.0	2.0	0.467	168.00	164.00
CLA46B27T5	✱	46.0	27.0	5.0	1.282	189.00	449.92
CLA46.5B27T4.5	✱	46.5	27.0	4.5	1.173	191.00	411.67
CLSA46.6B22.5T3	✱	46.6	22.5	3.0	0.729	177.00	255.71
CLA48B19T1	✱	48.0	18.8	1.0	0.247	168.28	86.79
CLA48B75T8	✱	48.0	75.0	8.0	4.150	380.00	1456.00
CLA48.5B18.8T1	✱	48.5	18.8	1.0	0.239	168.92	83.89
CLA48.5B24.5T1.7	✱	48.5	24.5	1.7	0.400	188.94	140.20
CLA49.5B38T3	✱	49.5	38.0	3.0	1.021	243.97	358.42
CLSA50B9T3	✱	50.0	9.0	3.0	0.529	128.37	185.53
CLA50B10T3	✱	50.0	10.0	3.0	0.547	133.00	191.90
CLA50B15T3	✓	50.0	15.0	3.0	0.633	154.00	222.00
CLSA50B25T3	✓	50.0	25.0	3.0	0.793	191.50	278.30
CLSA50B25T3	✓	50.0	25.0	3.0	0.803	191.50	278.30
CLA50B30T4	✱	50.0	30.0	4.0	1.163	212.00	408.00
CLSA50B36T6	✱	50.0	36.0	6.0	1.730	228.57	606.87
CLSA50B50T3	✱	50.0	50.0	3.0	1.219	292.40	427.80
CLA50B50T3	✓	50.0	50.0	3.0	1.231	292.96	431.92
CLA50.6B20T1	✱	50.6	20.0	1.0	0.252	177.92	88.39
CLA51B13T1	✱	51.0	13.0	1.0	0.213	151.00	74.80



"✓" Stocked Item  
 "✱" Pre-order Only Item  
 (30-40 working days delivery)



# U Channels

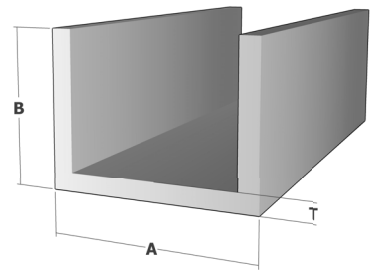

Product Code	Ex Stock	A (mm)	B (mm)	T (mm)	Mass (kg/m)	Perimeter (mm)	Area (mm <sup>2</sup> )
CLA51.1B20T1	✱	51.1	20.0	1.0	0.253	178.95	88.91
CLA51.4B110T4	✱	51.4	110.0	4.0	3.004	534.00	1054.00
CLSA51.8B25T0.9	✱	51.8	25.0	0.9	0.258	201.20	90.50
CLSA55B30T3	✱	55.0	30.0	3.0	0.929	221.40	326.00
CLA56B27T4.5	✱	56.0	27.0	4.5	1.295	210.00	454.42
CLA56B27T5	✱	56.0	27.0	5.0	1.425	209.00	499.92
CLA57B15T3	✓	57.0	15.0	3.0	0.693	168.00	243.00
CLA58B20T2	✱	58.0	20.0	2.0	0.536	192.00	188.00
CLA58B65T3.5	✓	58.0	65.0	3.5	1.873	367.42	657.10
CLSA69B59T4	✱	59.0	69.0	4.0	2.128	383.90	746.70
CLA60B40T3.5	✱	60.0	40.0	3.5	1.351	263.56	473.87
CLA60B70T4	✱	60.0	70.0	4.0	2.189	392.00	768.00
CLA60B110T4	✱	60.0	110.0	4.0	3.101	559.00	1088.00
CLSA61B150T5	✓	61.0	150.0	5.0	4.480	705.50	1571.98
CLA65B25T4	✓	65.0	25.0	4.0	1.220	222.00	428.00
CLA65B40T10	✱	65.0	40.0	10.0	3.809	259.13	1336.57
CLA68B19T1	✱	68.0	19.0	1.0	0.296	209.00	103.92
CLA70B12T1	✱	70.0	12.0	1.0	0.308	217.00	107.92
CLA70B20T1	✱	70.0	20.0	1.0	0.308	217.00	107.92
CLA75B25T3	✓	75.0	25.0	3.0	1.017	242.30	356.80
CLA75B40T3	✓	75.0	40.0	3.0	1.273	302.30	446.80
CLA76.5B12.8T1.1	✱	76.5	12.8	1.1	0.312	200.50	109.6
CLA80B36T5	✱	80.0	36.0	5.0	2.028	291.51	711.60
CLSA80B39.8T3.9	✱	80.0	39.8	3.9	1.701	305.39	596.96
CLA80B30T2	✱	80.0	30.0	2.0	0.778	276.00	272.97
CLA80B40T3	✓	80.0	40.0	3.0	1.317	314.00	462.00
CLA80B40T5	✓	80.0	40.0	5.0	2.137	308.97	749.92
CLSA90B75T13	✱	90.0	75.0	13.0	6.888	450.57	2416.87
CLA100B25T3	✓	100.0	25.0	3.0	1.231	292.30	431.80
CLA100B50T5	✓	100.0	50.0	5.0	2.707	388.97	949.92
CLSA100B60T5.5	✱	100.0	60.0	5.5	3.429	426.00	1203.00
CLSA100B85T1.7	✱	100.0	85.0	1.7	1.158	478.96	406.31
CLA100B100T5	✱	100.0	100.0	5.0	4.133	589.00	1450.00
CLA101.6B12.8T1.1	✱	101.6	12.8	1.1	0.391	251.00	137.20
CLSA104B45T8	✱	104.0	45.0	8.0	4.269	372.00	1498.00
CLA108B48T2.6	✱	108.0	48.0	2.6	1.473	401.80	516.80
CLA110B15T3	✱	110.0	15.0	3.0	1.148	272.28	402.79
CLA116B40.5T5	✱	116.0	40.5	5.0	2.555	382.51	896.50
CLSA120B85T1.7	✱	120.0	85.0	1.7	1.255	518.95	440.31
CLSA127B69.85T4.83	✱	127.0	69.85	4.83	4.879	514.56	1711.77

“✓” Stocked Item  
 “\*” Pre-order Only Item  
 (30-40 working days delivery)



# U Channels

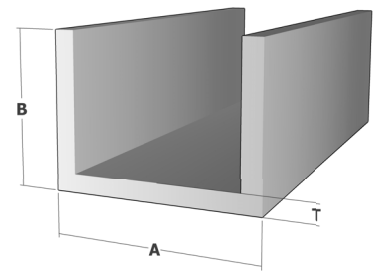

Product Code	Ex Stock	A (mm)	B (mm)	T (mm)	Mass (kg/m)	Perimeter (mm)	Area (mm <sup>2</sup> )
CLSA150B61T5	✓	150.0	61.0	5.0	3.734	540.00	1310.00
CLSA150B65T6.5	*	150.0	65.0	6.5	5.068	537.64	1778.30
CLA150B75T5	✓	150.0	75.0	5.0	4.132	588.30	1449.80
CLA152.4B82.6T5.33	*	152.4	82.6	5.33	6.299	617.80	2210.19
CLSA170B100T6	*	170.0	100.0	6.0	6.048	719.42	2122.25
CLA180B52T15	*	180.0	52.0	15.0	10.859	538.00	3810.00
CLA180B120T15	*	180.0	120.0	15.0	16.673	810.00	5850.00
CLSA180B120T15	*	180.0	120.0	15.0	15.421	811.71	5410.73
CLSA200B70T10	*	200.0	70.0	10.0	9.242	651.42	3242.92
CLSA203.2B95.3T6.35	*	203.2	95.3	6.35	9.049	767.07	3175.14
CLSA254B88.9T6.35	*	254.0	88.9	6.35	9.592	843.30	3365.51
CLSA280B53T11	*	280.0	53.0	11.0	10.258	744.85	3599.45
CLSA280B53T21	*	280.0	53.0	21.0	18.067	742.85	6339.45
CLSA300B100T7	*	300.0	100.0	7.0	9.696	986.00	3402.00

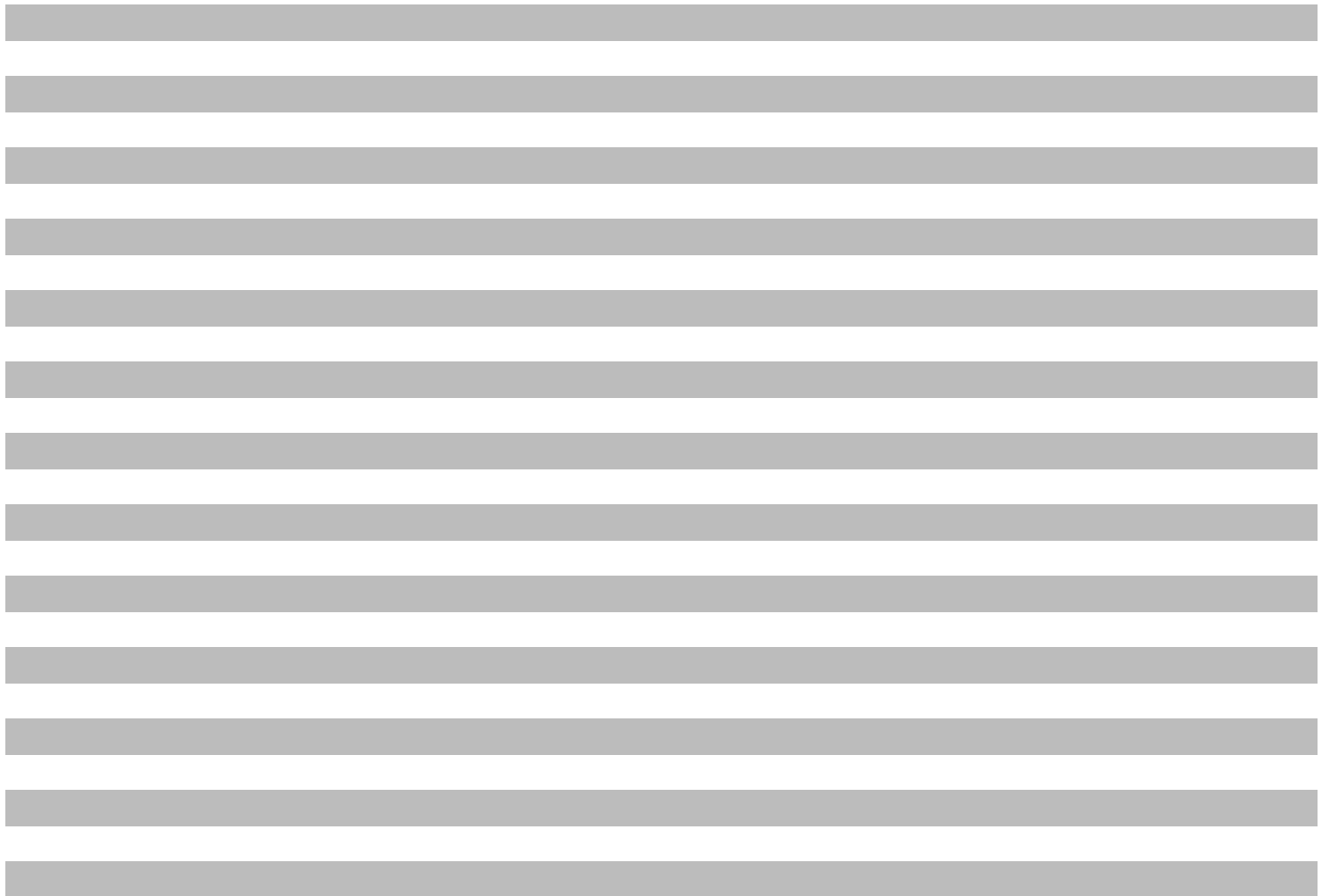

"✓" Stocked Item  
 "✱" Pre-order Only Item  
 (30-40 working days delivery)



# Flat Bars

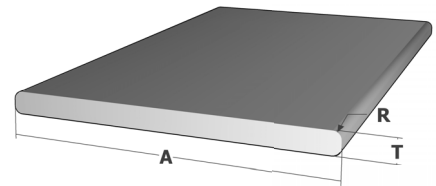

Product Code	Ex Stock	A (mm)	T (mm)	R (mm)	Mass (kg/m)	Perimeter (mm)	Area (mm <sup>2</sup> )
FBRA6.9T4.9R2.5	*	6.9	4.9	2.5	0.082	19.40	28.70
FBA7.5T2	*	7.5	2.0		0.043	19.00	15.00
FBA8T4	*	8.0	4.0		0.091	24.00	32.00
FBA10T2	*	10.0	2.0		0.057	24.00	20.00
FBA10T3	*	10.0	3.0		0.086	26.00	30.00
FBA10T6	*	10.0	6.0		0.171	32.00	60.00
FBA11.4T4.4	*	11.4	4.4		0.143	31.60	50.16
FBA12T3	✓	12.0	3.0		0.103	30.00	36.00
FBA13T6	*	13.0	6.0		0.222	38.00	78.00
FBA15T2	*	15.0	2.0		0.085	33.50	29.90
FBRA15T2.7R1	*	15.0	2.7	1.0	0.113	33.70	39.64
FBA15T4	*	15.0	4.0		0.170	37.14	59.79
FBA16T3	✓	16.0	3.0		0.136	37.20	47.80
FBRA16T4R4.7	*	16.0	4.0	4.7	0.180	38.18	62.76
FBA18T1.8	*	18.0	1.8		0.092	39.60	32.40
FBA19T1.2	*	19.0	1.2		0.062	42.00	21.89
FBA19T2	*	19.0	2.0		0.108	42.00	38.00
FBA19T3	*	19.0	3.0		0.162	44.00	57.00
FBRA19T5R1	*	19.0	5.0	1.0	0.268	46.28	94.14
FBA20T1.5	✓	20.0	1.5		0.086	42.50	30.00
FBA20T2	*	20.0	2.0		0.114	44.00	40.00
FBA20T2.5	*	20.0	2.5		0.143	45.00	50.00
FBA20T2.8	✓	20.0	2.8		0.160	45.60	56.00
FBA20T3	*	20.0	3.0		0.171	46.00	60.00
FBA20T5	*	20.0	5.0		0.285	50.00	100.00
FBA23T4	*	23.0	4.0		0.262	54.00	92.00
FBA20T10	*	20.0	10.0		0.570	60.00	200.00
FBA23T10	*	23.0	10.0		0.656	66.00	230.00
FBA25T1.5	*	25.0	1.5		0.107	53.00	37.50
FBA25T2	*	25.0	2.0		0.143	54.00	50.00
FBA25T2.5	✓	25.0	2.5		0.178	55.00	62.50
FBA25T3	✓	25.0	3.0		0.214	55.50	74.92
FBA25T4	*	25.0	4.0		0.285	58.40	99.90
FBA25T5	✓	25.0	5.0		0.356	60.00	125.00
FBA25T10	*	25.0	10.0		0.356	60.00	125.00
FBA28T1.5	*	28.0	1.5		0.119	58.50	41.90
FBA28T3	*	28.0	3.0		0.239	62.00	84.00
FBA28T5.8	*	28.0	5.8		0.462	66.74	162.20
FBA28T8	*	28.0	8.0		0.638	71.14	223.80
FBA28T14	*	28.0	14.0		1.117	83.14	391.80

"✓" Stocked Item  
 "✱" Pre-order Only Item  
 (30-40 working days delivery)



# Flat Bars

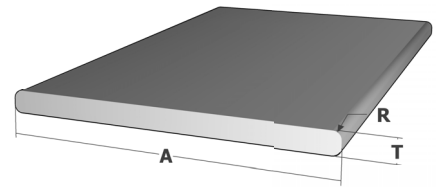

Product Code	Ex Stock	A (mm)	T (mm)	R(mm)	Mass (kg/m)	Perimeter (mm)	Area (mm <sup>2</sup> )
FBA28.3T2	✱	28.3	2.0		0.161	60.60	56.60
FBA29.5T3.9	✱	29.5	3.9		0.328	66.80	115.05
FBA30T1.2	✱	30.0	1.2		0.092	61.26	32.74
FBA30T2	✱	30.0	2.0		0.171	64.00	60.00
FBA30T2.5	✱	30.0	2.5		0.214	65.00	75.00
FBA30T3	✱	30.0	3.0		0.257	66.00	90.00
FBRA30T3R1	✱	30.0	3.0	1.0	0.254	64.28	89.14
FBA30T4.8	✱	30.0	4.8		0.410	69.60	144.00
FBSA30T5	✱	30.0	5.0		0.428	70.00	150.00
FBRSA32T22R3	✱	32.0	22.0	3.0	1.995	105.00	700.03
FBRA34.5T3.8R1	✱	34.5	3.8	1.0	0.374	76.60	131.10
FBA35T5	✱	35.0	5.0		0.499	80.00	175.00
FBRA35T5R1	✱	35.0	5.0	1.0	0.496	78.28	174.14
FBA35T20	✱	35.0	20.0		2.000	110.00	700.00
FBRA37.6T5.5R2.7	✱	37.6	5.5	2.7	0.571	82.00	200.30
FBA38T10	✱	38.0	10.0		0.669	207.27	234.74
FBA38T13	✱	38.0	13.0		1.408	102.00	494.00
FBRA38.1T3R1.5	✓	38.1	3.0	1.5	0.326	82.20	114.30
FBRA38.1T6.3R3.1	✓	38.1	6.3	3.1	0.684	88.80	240.03
FBA40T0.9	✱	40.0	0.9		0.103	81.80	36.00
FBA40T1.5	✱	40.0	1.5		0.171	82.50	59.92
FBA40T2.9	✓	40.0	2.9		0.331	85.80	116.00
FBRA40T5R2.5	✱	40.0	5.0	2.5	0.555	85.70	194.60
FBA40T6	✓	40.0	6.0		0.684	92.00	240.00
FBA40T8.2	✱	40.0	8.2		0.935	96.40	328.00
FBA40T10	✓	40.0	10.0		1.140	100.00	400.00
FBA45T10	✓	45.0	10.0		1.282	110.00	449.92
FBA45T42	✱	45.0	42.0		5.387	174.00	1890.00
FBA45.2T3.2	✱	45.2	3.2		0.412	96.80	144.64
FBA46T2	✱	46.0	2.0		0.262	96.00	92.00
FBA47.5T1.3	✓	47.5	1.3		0.176	97.60	61.75
FBA47.6T1.5	✱	47.6	1.5		0.203	97.70	71.32
FBRA49T5R2.5	✱	49.0	5.0	2.5	0.695	108.00	245.00
FBRA50T3R1.5	✱	50.0	3.0	1.5	0.428	106.00	150.00
FBA50T3	✓	50.0	3.0		0.428	106.00	150.00
FBA50T3.5	✱	50.0	3.5		0.500	107.00	175.00
FBA50T4	✱	50.0	4.0		0.570	108.00	200.00
FBA50T5	✱	50.0	5.0		0.713	110.00	250.00
FBA50T6	✓	50.0	6.0		0.855	112.00	300.00
FBRA50T6R3	✱	50.0	6.0	3.0	0.855	112.00	300.00

"✓" Stocked Item  
 "✱" Pre-order Only Item  
 (30-40 working days delivery)



# Flat Bars

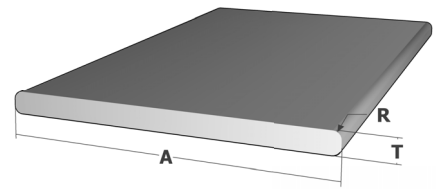

Product Code	Ex Stock	A (mm)	T (mm)	R(mm)	Mass (kg/m)	Perimeter (mm)	Area (mm <sup>2</sup> )
FBA50T10	✓	50.0	10.0		1.425	120.00	500.00
FBA50T12	✱	50.0	12.0		1.710	124.00	600.00
FBA50T20	✱	50.0	20.0		2.850	140.00	1000.00
FBA50T25	✱	50.0	25.0		3.563	150.00	1250.00
FBA55T1.7	✱	55.0	1.7		0.266	113.40	93.50
FBSA55T5	✱	55.0	5.0		0.784	120.00	275.00
FBSA55T8	✱	55.0	8.0		1.254	125.50	439.92
FBA56.5T27	✱	56.5	27.0		4.344	164.77	1524.05
FBA57.6T2.8	✱	57.6	2.8		0.460	120.80	161.28
FBA58T4	✱	58.0	4.0		0.661	124.00	232.00
FBA60T0.9	✱	60.0	0.9		0.154	121.80	54.00
FBA60T3	✓	60.0	3.0		0.512	125.20	179.80
FBA60T4	✱	60.0	4.0		0.684	128.00	240.00
FBA60T5	✓	60.0	5.0		0.855	130.00	300.00
FBA60T10	✓	60.0	10.0		1.710	140.00	600.00
FBA60T12	✱	60.0	12.0		2.052	144.00	720.00
FBRA64T5R2.5	✱	64.0	5.0	2.5	0.911	135.70	319.60
FBA65T8	✱	65.0	8.0		1.482	146.00	520.00
FBA70T2	✱	70.0	2.0		0.399	144.00	140.00
FBA70T4	✱	70.0	4.0		0.789	147.50	279.92
FBA70T10	✓	70.0	10.0		1.995	160.00	700.00
FBA70T15	✱	70.0	15.0		2.993	170.00	1050.00
FBA75T2	✓	75.0	2.0		0.428	154.00	150.00
FBA75T4	✓	75.0	4.0		0.855	158.00	300.00
FBA75T6	✓	75.0	6.0		1.283	162.00	450.00
FBA75T10	✱	75.0	10.0		1.283	162.00	450.00
FBA75T12	✱	75.0	12.0		2.565	174.00	900.00
FBA75T20	✱	75.0	20.0		4.275	190.00	1500.00
FBA77T6	✱	77.0	6.0		1.317	165.50	462.00
FBA80T6	✓	80.0	6.0		1.368	172.00	480.00
FBA80T10	✓	80.0	10.0		2.280	180.00	800.00
FBA80T12	✓	80.0	12.0		2.736	184.00	960.00
FBA84T4	✱	84.0	4.0		0.958	176.00	336.00
FBA84T5	✱	84.0	5.0		1.197	177.48	419.92
FBA84T6	✱	84.0	6.0		1.436	180.00	504.00
FBA88T5	✱	88.0	5.0		1.254	185.50	440.00
FBA90T3	✓	90.0	3.0		0.769	185.50	269.92
FBRA90T5R2.5	✓	90.0	5.0	2.5	1.267	185.70	444.60
FBRA90T6R3	✓	90.0	6.0	3.0	1.517	186.90	532.30
FBA95T3.5	✱	95.0	3.5		0.925	197.00	332.40

"✓" Stocked Item  
 "✱" Pre-order Only Item  
 (30-40 working days delivery)



# Flat Bars

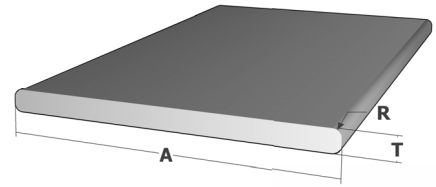

Product Code	Ex Stock	A (mm)	T (mm)	R (mm)	Mass (kg/m)	Perimeter (mm)	Area (mm <sup>2</sup> )
FBA96T6	✱	96.0	6.0		1.925	204.00	576.00
FBA100T1.5	✱	100.0	1.5		0.430	203.00	150.00
FBA100T3	✓	100.0	3.0		0.855	206.00	300.00
FBA100T3	✱	100.0	4.0		1.140	208.00	400.00
FBA100T6	✓	100.0	6.0		1.709	211.20	599.80
FBA100T8	✱	100.0	8.0		2.280	216.00	800.00
FBA100T10	✓	100.0	10.0		2.850	220.00	1000.00
FBRA100T10R5	✱	100.0	10.0	5.0	2.789	211.42	978.54
FBA100T12	✓	100.0	12.0		3.420	224.00	1200.00
FBA106T6	✱	106.0	6.0		1.813	224.00	636.00
FBA110T2	✱	110.0	2.0		0.627	224.00	220.00
FBA110T8	✓	110.0	8.0		2.508	236.00	880.00
FBA116T6	✱	116.0	6.0		1.984	224.00	696.00
FBA117T3.7	✱	117.0	3.7		1.234	241.40	432.90
FBRA119T5R2.5	✱	119.0	5.0	2.5	1.682	243.70	590.00
FBA120T6	✓	120.0	6.0		2.052	252.00	720.00
FBRA120T6R3	✓	120.0	6.0	3.0	2.030	246.90	712.30
FBA120T8	✱	120.0	8.0		2.736	256.00	960.00
FBA120T12	✱	120.0	12.0		4.104	264.00	1440.00
FBA123T4.8	✱	123.0	4.8		1.683	255.60	590.40
FBA123T5.5	✱	123.0	5.5		1.928	257.00	676.50
FBA123T3.5	✱	123.0	3.5		1.227	253.00	430.50
FBA125T6	✱	125.0	6.0		2.138	262.00	750.00
FBA125T10	✱	125.0	10.0		2.138	262.00	750.00
FBA125T12	✱	125.0	10.0		2.138	262.00	750.00
FBA126T6	✱	126.0	6.0		2.155	264.00	756.00
FBA133.5T6	✱	133.5	6.0		2.283	279.00	801.00
FBA136T4	✱	136.0	4.0		1.550	280.00	544.00
FBA136T6	✱	136.0	6.0		2.326	284.00	816.00
FBA138T5.8	✓	138.0	5.8		2.281	287.60	800.40
FBRA140T5.9R2.9	✱	140.0	5.9	2.9	2.333	286.70	818.50
FBA140T10	✱	140.0	10.0		3.990	300.00	1400.00
FBA142T3.6	✱	142.0	3.6		1.457	291.20	511.20
FBA143T25	✱	143.0	25.0		10.189	336.00	3575.00
FBA145T6	✓	145.0	6.0		2.480	302.00	870.00
FBA150T3	✓	150.0	3.0		1.283	306.00	450.00
FBA150T5	✱	150.0	5.0		2.138	310.00	750.00
FBA150T10	✓	150.0	10.0		4.275	319.50	1500.00
FBA150T13.5	✓	150.0	13.5		5.771	327.00	2025.00
FBA151T3.2	✱	151.0	3.2		1.377	308.40	483.20

"✓" Stocked Item  
 "✱" Pre-order Only Item  
 (30-40 working days delivery)



# Flat Bars

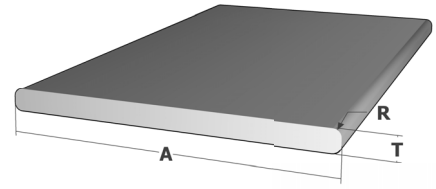

Product Code	Ex Stock	A (mm)	T (mm)	R (mm)	Mass (kg/m)	Perimeter (mm)	Area (mm <sup>2</sup> )
FBA151T4.8	✱	151.0	4.8		2.066	311.60	724.80
FBA151T5.8	✱	151.0	5.8		2.496	313.60	875.80
FBA151T3.7	✱	151.0	3.7		1.592	309.40	588.70
FBRA160T5.9R2.9	✱	160.0	5.9	2.9	2.670	427.00	937.00
FBA160T10	✓	160.0	10.0		4.560	340.00	1600.00
FBA160T20	✱	160.0	20.0		9.120	340.00	3200.00
FBA200T5	✓	200.0	5.0		2.850	410.00	1000.00
FBA200T10	✓	200.0	10.0		5.700	420.00	2000.00
FBA200T11	✓	200.0	11.0		6.270	422.00	2200.00
FBRA209T5.9R2.9	✱	209.0	5.9	2.9	3.493	424.70	1225.60
FBA220T5	✓	220.0	5.0		3.135	450.00	1100.00
FBA222T1.8	✱	222.0	1.8		1.139	447.60	399.60
FBA270T6	✱	270.0	6.0		4.617	552.00	1620.00
FBA270T9	✓	270.0	9.0		6.926	558.00	2430.00
FBA270T14	✱	270.0	14.0		10.773	568.00	3780.00
FBA300T4	✱	300.0	4.0		3.420	608.00	1200.00
FBA300T10	✓	300.0	10.0		8.550	619.50	2999.92

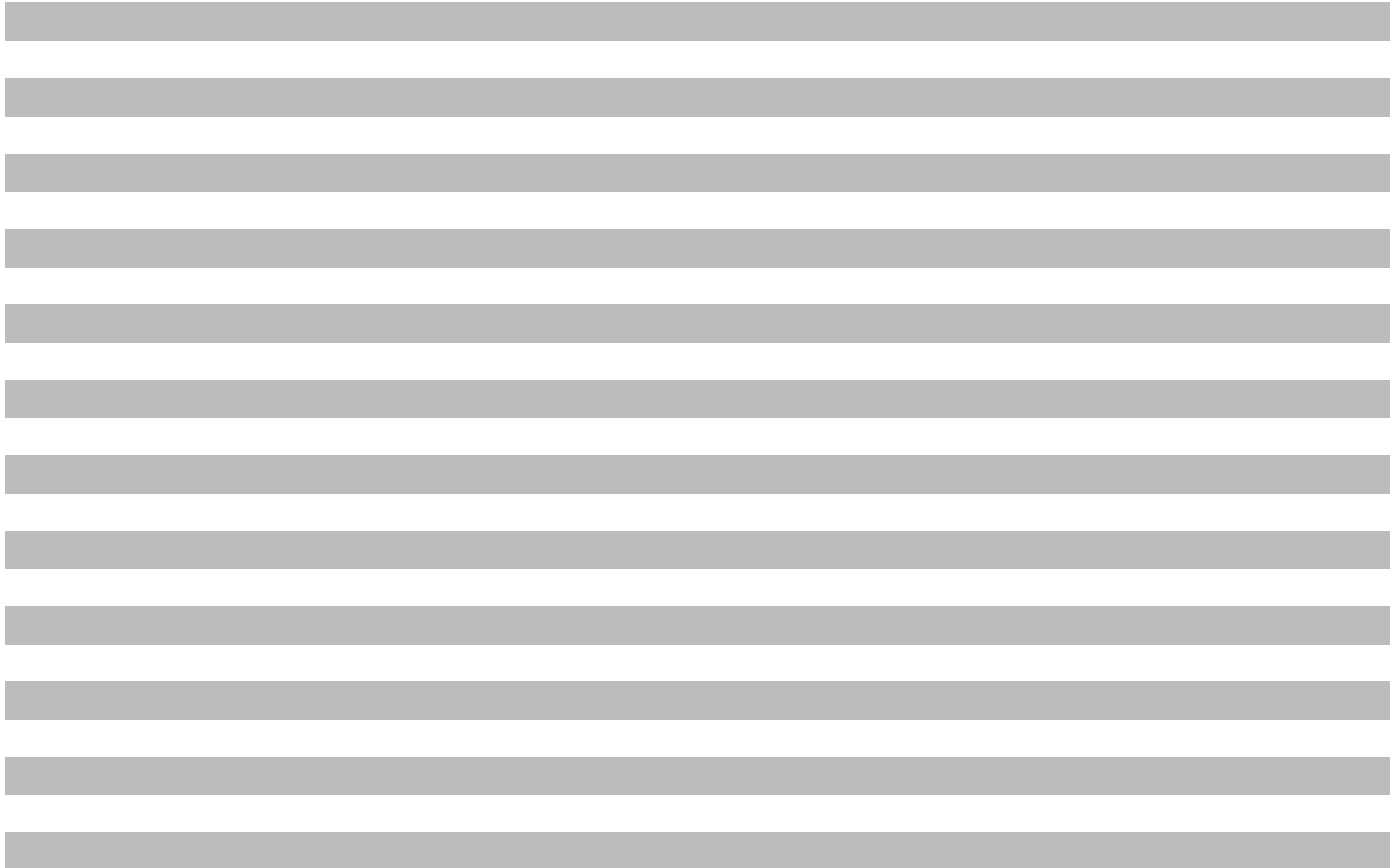

"✓" Stocked Item  
 "✱" Pre-order Only Item  
 (30-40 working days delivery)



# Tee Bars

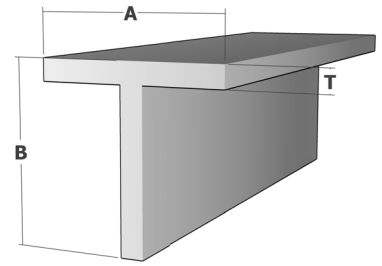

Product Code	Ex Stock	A (mm)	B (mm)	T (mm)	Mass (kg/m)	Perimeter (mm)	Area (mm <sup>2</sup> )
TBA15B15T1.5	✱	15.0	15.0	1.5	0.122	60.00	42.75
TBA15B80T3	✱	15.0	80.0	3.0	0.787	190.00	276.00
TBA19B19T3.2	✓	19.0	19.0	3.2	0.316	76.71	110.89
TBA15B35T1.1	✱	15.0	35.0	1.1	0.153	98.97	53.71
TBA20B10T1.5	✓	20.0	10.0	1.5	0.122	59.00	42.68
TBA20B11.5T4	✓	20.0	11.5	4.0	0.292	62.00	102.42
TBA20B20T1.5	✓	20.0	20.0	1.5	0.165	80.00	57.75
TBSA22.8B42.7T1	✱	22.8	42.7	1.0	0.189	129.37	66.35
TBA25B25T3	✓	25.0	25.0	3.0	0.401	98.30	140.80
TBSA30B40T4	✱	30.0	40.0	4.0	0.763	137.44	267.86
TBSA35.8B68T2.8	✱	35.8	68.0	2.8	1.139	231.00	399.50
TBSA35.8B78T2.8	✱	35.8	78.0	2.8	1.269	253.80	445.30
TBSA35.8B88T2.8	✱	35.8	88.0	2.8	1.400	277.00	491.20
TBSA35.8B98T2.8	✱	35.8	98.0	2.8	1.530	300.00	537.00
TBSA37B53.7T3.7	✱	37.0	53.7	3.7	0.908	184.00	318.76
TBA40B20T1.5	✓	40.0	20.0	1.5	0.250	118.30	87.60
TBA40B40T3	✓	40.0	40.0	3.0	0.658	158.30	230.80
TBA40B40T6	✓	40.0	40.0	6.0	1.265	158.30	443.80
TBA40B50T6	✓	40.0	50.0	6.0	1.436	178.30	503.80
TBSA41B32T1.5	✓	41.0	32.0	1.5	0.353	143.00	123.90
TBSA45B25T2.5	✱	45.0	25.0	2.5	0.481	139.23	168.63
TBA50B50T3	✓	50.0	50.0	3.0	0.829	199.00	290.92
TBA50B50T6	✓	50.0	50.0	6.0	1.607	198.30	563.80
TBA50B100T6	✓	50.0	100.0	6.0	2.462	298.30	863.80
TBA51B62T16.7	✱	51.0	62.0	16.7	4.207	225.15	1476.17
TBA55B55T3	✱	55.0	55.0	3.0	0.915	220.00	321.00
TBSA60B30T4.5	✱	60.0	30.0	4.5	1.351	179.00	473.92
TBSA60B30T5.5	✱	60.0	30.0	5.5	1.499	179.00	525.92
TBSA60B60T6	✱	60.0	60.0	6.0	1.949	240.00	684.00
TBA60B70T2	✱	60.0	70.0	2.0	0.729	259.00	255.92
TBA63.5B63.5T6.35	✓	63.5	63.5	6.35	2.183	252.30	766.00
TBA75B75T6	✓	75.0	75.0	6.0	2.462	298.30	863.80
TBA101B60T4	✱	101.0	60.0	4.0	1.809	318.57	634.87
TBA120B84T4	✱	120.0	84.0	4.0	2.280	406.97	800.00
TBA150B100T8	✱	150.0	100.0	8.0	5.518	500.00	1936.00



"✓" Stocked Item  
 "\*" Pre-order Only Item  
 (30-40 working days delivery)



# Solid Rounds

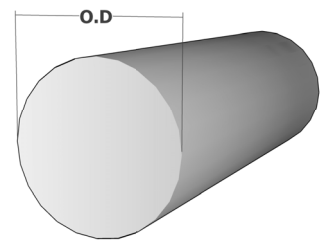

Product Code	Ex Stock	O.D (mm)	Mass (kg/m)	Perimeter (mm)	Grade & Temper
SRD4.4L3	*	4.4	0.043	13.82	6063-T6
SRD5L3	*	5.0	0.056	15.71	6063-T6
SRD5.3L3	*	5.3	0.063	16.65	6063-T6
SRD6L3	*	6.0	0.081	18.90	6063-T6
SRD6.3L3	*	6.3	0.089	19.79	6063-T6
SRD6.8L3	*	6.8	0.104	21.36	6063-T6
SRD7L3	*	7.0	0.110	21.99	6063-T6
SRD8L3	*	8.0	0.143	25.13	6063-T6
SRD9.53L3	✓	9.53	0.203	30.00	6063-T6
SRD9.7L3	*	9.7	0.211	30.50	6063-T6
SRD10L3	*	10.0	0.224	31.42	6063-T6
SRD10.5L3	*	10.5	0.247	32.99	6063-T6
SRD11L3	*	11.0	0.271	34.56	6063-T6
SRD11.8L3	*	11.8	0.312	37.10	6063-T6
SRD12L3	*	12.0	0.322	37.70	6063-T6
SRD12.7L3	✓	12.7	0.361	40.00	6063-T6
SRD13L3	*	13.0	0.378	40.84	6063-T6
SRD14L3	*	14.0	0.439	44.00	6063-T6
SRD15L3	*	15.0	0.504	47.12	6063-T6
SRD15.6L3	*	15.6	0.545	49.00	6063-T6
SRD16L3	*	16.0	0.573	50.27	6063-T6
SRD17L3	*	17.0	0.647	53.40	6063-T6
SRD18L3	*	18.0	0.725	56.55	6063-T6
SRD19L3	*	19.0	0.808	59.70	6063-T6
SRD20L3	✓	20.0	0.895	62.80	6063-T6
SRD21L3	*	21.0	0.987	66.00	6063-T6
SRD22L3	*	22.0	1.083	69.12	6063-T6
SRD23L3	*	23.0	1.184	72.26	6063-T6
SRD24L3	*	24.0	1.289	75.40	6063-T6
SRD25L3	*	25.0	1.399	78.54	6063-T6
SRD25.4L3	✓	25.4	1.444	79.80	6063-T6
SRD26L3	*	26.0	1.513	81.70	6063-T6
SRD26.2L3	*	26.2	1.537	82.31	6063-T6
SRD26.5L3	✓	26.5	1.572	83.25	6063-T6
SRD27L3	✓	27.0	1.623	84.80	6063-T6
SRD28L3	*	28.0	1.755	88.00	6063-T6
SRD29L3	*	29.0	1.882	91.11	6063-T6
SRD32L3	*	32.0	2.292	100.53	6063-T6
SRD33L3	*	33.0	2.438	103.67	6063-T6
SRD34L3	*	34.0	2.588	106.81	6063-T6

“✓” Stocked Item  
 “\*” Pre-order Only Item  
 (30-40 working days delivery)



# Solid Rounds

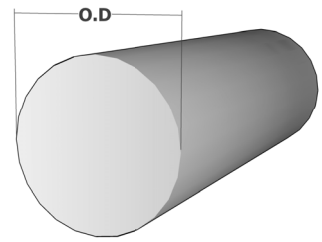

Product Code	Ex Stock	O.D (mm)	Mass (kg/m)	Perimeter (mm)	Grade & Temper
SRD35L3	*	35.0	2.742	109.96	6063-T6
SRD36L3	*	36.0	2.901	113.10	6063-T6
SRD37.5L3	*	37.5	3.148	117.81	6063-T6
SRD38.1L3	✓	38.1	3.249	119.70	6063-T6
SRD39.5L3	*	39.5	3.492	124.10	6063-T6
SRD40L3	*	40.0	3.581	125.66	6063-T6
SRD41.28L3	✓	41.28	3.814	129.70	6063-T6
SRD42L3	*	42.0	3.949	131.95	6063-T6
SRD42.8L3	*	42.8	4.100	134.46	6063-T6
SRD44.5L3	*	44.5	4.423	139.70	6063-T6
SRD47.7L3	*	47.7	5.093	149.90	6063-T6
SRD50L3	*	50.0	5.596	157.08	6063-T6
SRD50.8L3	✓	50.8	5.777	159.60	6063-T6
SRD54L3	✓	54.0	6.527	169.70	6063-T6
SRD60.32L3	✓	60.32	8.144	189.50	6063-T6
SRD64L3	*	64.0	9.168	201.10	6063-T6
SRD69.5L3	✓	69.5	10.812	177.12	6061-T6
SRD76.2L3	✓	75.0	12.315	239.39	6061-T6
SRD88.9L3	✓	90.0	16.820	279.29	6061-T6
SRD101.6L3	✓	100.0	21.900	319.19	6061-T6
SRD127L3	✓	127.0	34.210	398.98	6061-T6
SRD150L3	✓	150.0	49.260	478.78	6061-T6
SRD165L3	*	165.0	60.940	518.36	6061-T6
SRD203L3	*	203.0	92.242	637.74	6061-T6
SRD250L3	*	250.0	139.900	785.40	6061-T6
SRD280L3	*	280.0	175.489	879.65	6061-T6

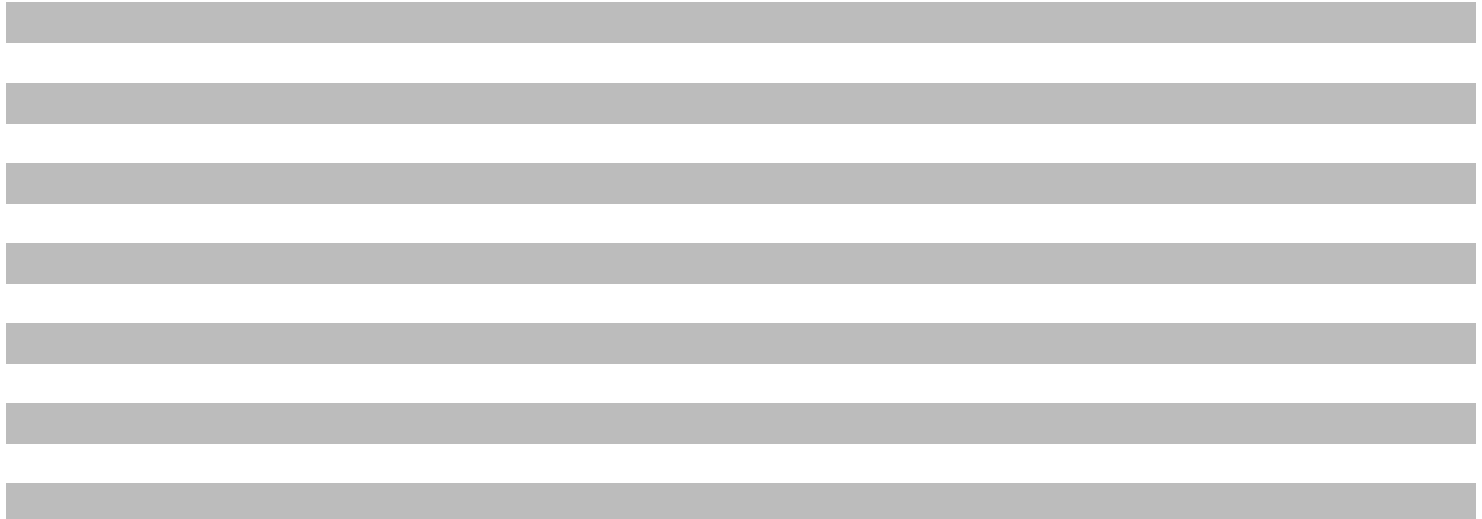

"✓" Stocked Item  
 "✱" Pre-order Only Item  
 (30-40 working days delivery)



# Solid Square

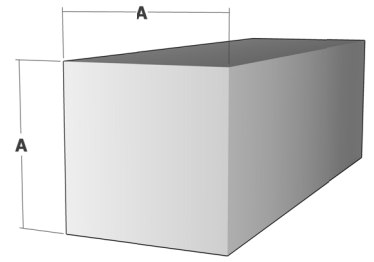

Product Code	Ex Stock	A (mm)	Mass (kg/m)	Perimeter (mm)	Grade & Temper
SQBA8L3	✱	8.0	0.175	29.00	6063-T6
SQBA8L3	✱	8.0	0.175	29.00	6063-T6
SQBA10L3	✓	10.0	0.284	39.10	6063-T6
SQBA12L3	✓	12.0	0.401	47.10	6063-T6
SQBA16L3	✓	16.0	0.729	63.10	6063-T6
SQBA19L3	✓	19.0	1.034	75.30	6063-T6
SQBA20L3	✓	20.0	1.139	79.10	6063-T6
SQBA25L3	✓	25.0	1.781	99.10	6063-T6
SQBA31.8L3	✓	31.8	2.881	126.30	6063-T6
SQBA33L3	✱	33.0	3.104	132.00	6063-T6
SQBA38.1L3	✓	38.1	4.136	151.40	6063-T6
SQBA40L3	✓	40.0	4.560	160.00	6063-T6
SQBA42L3	✓	42.0	5.027	168.00	6063-T6
SQBA44.5L3	✓	44.5	5.643	177.10	6063-T6
SQBA51L3	✓	51.0	7.413	201.00	6063-T6
SQBA60L3	✓	60.0	10.260	240.00	6063-T6
SQBA100L3	✓	100.0	28.500	400.00	6063-T6

"✓" Stocked Item  
 "\*" Pre-order Only Item  
 (30-40 working days delivery)



# Flat Sheet

5005 - H32

General Purpose

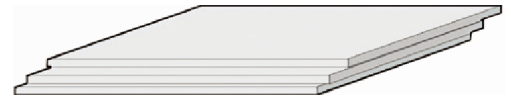

Product Code	Ex Stock	Thickness (mm)	Length (kg/m)	Width (mm)	Weight (kg)
5005AS121224	✓	0.75	1200	2400	5.93
5005AS121224	✓	1.20	1200	2400	9.48
5005AS15153	✓	1.50	1500	3000	18.90
5005AS161224	✓	1.60	1200	2400	12.72
5005AS16153	✓	1.60	1500	3000	20.30
5005AS161236	*	1.60	1200	3600	18.80
5005AS21224	✓	2.00	1200	2400	16.13
5005AS2153	✓	2.00	1500	3000	25.17
5005AS251224	✓	2.50	1200	2400	20.14
5005AS31224	✓	3.00	1200	2400	23.88
5005AS3153	✓	3.00	1500	3000	37.86
5005AS41224	✓	4.00	1200	2400	31.91
5005AS4153	✓	4.00	1500	3000	50.79
5005AS51224	✓	5.00	1200	2400	39.73
5005AS5153	✓	5.00	1500	3000	64.32
5005AS61224	✓	6.00	1200	2400	47.71

# Flat Sheet

5052 - H32

Marine Grade



Product Code	Ex Stock	Thickness (mm)	Length (kg/m)	Width (mm)	Weight (kg)
5052AS161224	✓	1.60	1200	2400	12.53
5052AS21224	✓	2.00	1200	2400	16.18
5052AS31224	✓	3.00	1200	2400	24.35
5052AS3153	✓	3.00	1500	3000	38.05
5052AS41224	✓	4.00	1200	2400	31.62

"✓" Stocked Item  
 "✱" Pre-order Only Item  
 (30-40 working days delivery)



# Flat Sheet

6061 - T6  
 Structural

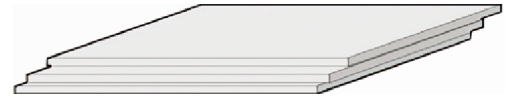

Product Code	Ex Stock	Thickness (mm)	Length (kg/m)	Width (mm)	Weight (kg)
6061AS412525	✓	4.00	1250	2500	34.00
6061AS612525	✓	6.00	1250	2500	54.20
6061AS812525	✓	8.00	1250	2500	71.45
6061AS8153	✓	8.00	1500	3000	107.91
6061AS1012525	✓	10.00	1250	2500	90.92
6061AS1212525	✓	12.00	1250	2500	103.00

# Flat Sheet

5083 - H116  
 Hard Marine & Transport



Product Code	Ex Stock	Thickness (mm)	Length (kg/m)	Width (mm)	Weight (kg)
5083AS31224	✓	3.00	1200	2400	22.95
5083AS41224	✓	4.00	1200	2400	30.60
5083AS51224	✓	5.00	1200	2400	38.20
5083AS61224	✓	6.00	1200	2400	45.90
5083AS81224	✓	8.00	1200	2400	61.20
5083AS101224	✓	10.00	1200	2400	76.50
5083AS121224	✓	12.00	1200	2400	91.80

"✓" Stocked Item  
 "✱" Pre-order Only Item  
 (30-40 working days delivery)



# Standard Treadplate

5052 - H32

5 Bar Pattern



Product Code	Ex Stock	Thickness (mm)	Length (kg/m)	Width (mm)	Weight (kg)
5052TP15153	✓	1.50	1500	3000	18.90
5052TP161224	✓	1.60	1200	2400	13.82
5052TP21224	✓	2.00	1200	2400	17.06
5052TP251224	✓	2.50	1200	2400	21.67
5052TP31224	✓	3.00	1200	2400	25.89
5052TP3153	✓	3.00	1500	3000	40.25
5052TP41224	✓	4.00	1200	2400	33.41
5052TP51224	✓	5.00	1200	2400	41.76
5052TP61224	✓	6.00	1200	2400	50.11
5052TP6153	✓	6.00	1500	3000	77.16

# Honeycomb Panel

*Powdercoated both sides of surfaces*

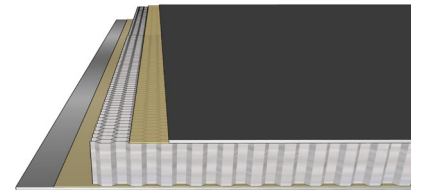

Product Code	Ex Stock	Thickness (mm)	Length (kg/m)	Width (mm)	Colour
HS1712525MF	✓	17.00	1250	2500	Mill Finish
HS1712525Ironsand	✓	17.00	1250	2500	Ironsand
HS1712525Black	✓	17.00	1250	2500	Black

*One side powdercoated, one side mill finish*

Product Code	Ex Stock	Thickness (mm)	Length (kg/m)	Width (mm)	Colour
HS1461022MF	✓	14.60	1000	2200	Mill Finish
HS1461022Black	✓	14.60	1000	2200	Black
HS1461022Ironsand	✓	14.60	1000	2200	Ironsand
HS14610245MF	✓	14.60	1000	2450	Mill Finish
HS14610245Black	✓	14.60	1000	2450	Black
HS14610245Ironsand	✓	14.60	1000	2450	Ironsand

"✓" Stocked Item  
 "\*" Pre-order Only Item  
 (30-40 working days delivery)



# Flat Sheet

5005 - H32

General Purpose

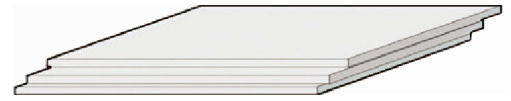

Product Code	Ex Stock	Thickness (mm)	Length (kg/m)	Width (mm)	Weight (kg)
5005AS121224	✓	0.75	1200	2400	5.93
5005AS121224	✓	1.20	1200	2400	9.48
5005AS15153	✓	1.50	1500	3000	18.90
5005AS161224	✓	1.60	1200	2400	12.72
5005AS16153	✓	1.60	1500	3000	20.30
5005AS161236	*	1.60	1200	3600	18.80
5005AS21224	✓	2.00	1200	2400	16.13
5005AS2153	✓	2.00	1500	3000	25.17
5005AS251224	✓	2.50	1200	2400	20.14
5005AS31224	✓	3.00	1200	2400	23.88
5005AS3153	✓	3.00	1500	3000	37.86
5005AS41224	✓	4.00	1200	2400	31.91
5005AS4153	✓	4.00	1500	3000	50.79
5005AS51224	✓	5.00	1200	2400	39.73
5005AS5153	✓	5.00	1500	3000	64.32
5005AS61224	✓	6.00	1200	2400	47.71

# Flat Sheet

5052 - H32

Marine Grade



Product Code	Ex Stock	Thickness (mm)	Length (kg/m)	Width (mm)	Weight (kg)
5052AS161224	✓	1.60	1200	2400	12.53
5052AS21224	✓	2.00	1200	2400	16.18
5052AS31224	✓	3.00	1200	2400	24.35
5052AS3153	✓	3.00	1500	3000	38.05
5052AS41224	✓	4.00	1200	2400	31.62

“✓” Stocked Item  
“\*” Pre-order Only Item  
(30-40 working days delivery)



# Flat Sheet

6061 - T6

Structural

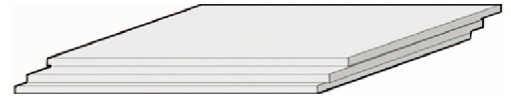

Product Code	Ex Stock	Thickness (mm)	Length (kg/m)	Width (mm)	Weight (kg)
6061AS412525	✓	4.00	1250	2500	34.00
6061AS612525	✓	6.00	1250	2500	54.20
6061AS812525	✓	8.00	1250	2500	71.45
6061AS8153	✓	8.00	1500	3000	107.91
6061AS1012525	✓	10.00	1250	2500	90.92
6061AS1212525	✓	12.00	1250	2500	103.00

# Flat Sheet

5083 - H116

Hard Marine & Transport



Product Code	Ex Stock	Thickness (mm)	Length (kg/m)	Width (mm)	Weight (kg)
5083AS31224	✓	3.00	1200	2400	22.95
5083AS41224	✓	4.00	1200	2400	30.60
5083AS51224	✓	5.00	1200	2400	38.20
5083AS61224	✓	6.00	1200	2400	45.90
5083AS81224	✓	8.00	1200	2400	61.20
5083AS101224	✓	10.00	1200	2400	76.50
5083AS121224	✓	12.00	1200	2400	91.80



"✓" Stocked Item  
 "✱" Pre-order Only Item  
 (30-40 working days delivery)



# Standard Treadplate

5052 - H32

5 Bar Pattern



Product Code	Ex Stock	Thickness (mm)	Length (kg/m)	Width (mm)	Weight (kg)
5052TP15153	✓	1.50	1500	3000	18.90
5052TP161224	✓	1.60	1200	2400	13.82
5052TP21224	✓	2.00	1200	2400	17.06
5052TP251224	✓	2.50	1200	2400	21.67
5052TP31224	✓	3.00	1200	2400	25.89
5052TP3153	✓	3.00	1500	3000	40.25
5052TP41224	✓	4.00	1200	2400	33.41
5052TP51224	✓	5.00	1200	2400	41.76
5052TP61224	✓	6.00	1200	2400	50.11
5052TP6153	✓	6.00	1500	3000	77.16

# Honeycomb Panel

*Powdercoated both sides of surfaces*

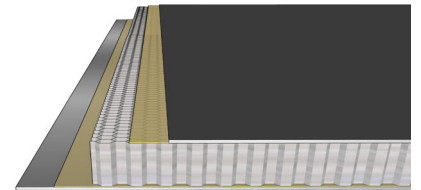

Product Code	Ex Stock	Thickness (mm)	Length (kg/m)	Width (mm)	Colour
HS1712525MF	✓	17.00	1250	2500	Mill Finish
HS1712525Ironsand	✓	17.00	1250	2500	Ironsand
HS1712525Black	✓	17.00	1250	2500	Black

*One side powdercoated, one side mill finish*

Product Code	Ex Stock	Thickness (mm)	Length (kg/m)	Width (mm)	Colour
HS1461022MF	✓	14.60	1000	2200	Mill Finish
HS1461022Black	✓	14.60	1000	2200	Black
HS1461022Ironsand	✓	14.60	1000	2200	Ironsand
HS14610245MF	✓	14.60	1000	2450	Mill Finish
HS14610245Black	✓	14.60	1000	2450	Black
HS14610245Ironsand	✓	14.60	1000	2450	Ironsand



“✓” Stocked Item  
 “\*” Pre-order Only Item  
 (30-40 working days delivery)



# Galvanized Square Hollow

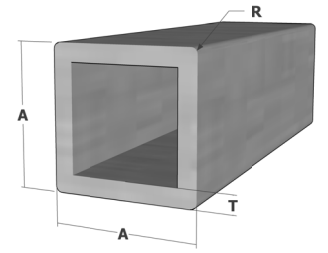

Product Code	Ex Stock	A (mm)	T (mm)	R (mm)	Mass (kg/m)	Area (mm <sup>2</sup> )
SHA20T1.5GALV	✓	20.0	1.5	2.0	0.818	107.78
SHA25T1.5GALV	✓	25.0	1.5	2.0	1.080	154.88
SHA25T2GALV	✓	25.0	2.0	2.0	1.463	186.18
SHA25T2.5GALV	*	25.0	2.5		1.789	242.00
SHA25T3GALV	*	25.0	3.0		2.099	290.40
SHA30T1.6GALV	*	30.0	1.6		1.445	186.88
SHA30T2GALV	✓	30.0	2.0	2.0	1.789	232.00
SHA30T2.5GALV	*	30.0	2.5		2.099	287.50
SHA40T1.6GALV	*	40.0	1.6		1.954	250.88
SHA40T2R3GALV	✓	40.0	2.0	3.0	2.471	314.46
SHA40T2.5R3GALV	✓	40.0	2.5	3.0	2.981	379.36
SHA40T3GALV	*	40.0	3.0		3.530	462.00
SHA40T4GALV	*	40.0	4.0		4.579	608.00
SHA50T1.6GALV	*	50.0	1.6		2.463	314.88
SHA50T2R3GALV	✓	50.0	2.0	3.0	3.053	388.52
SHA50T2.5GALV	*	50.0	2.5		3.776	487.50
SHA50T3GALV	*	50.0	3.0		4.484	582.00
SHA50T3R3GALV	✓	50.0	3.0	3.0	4.423	583.12
SHA50T4GALV	*	50.0	4.0		5.851	768.00
SHA50T5GALV	*	50.0	5.0		7.155	950.00
SHA65T1.6GALV	*	65.0	1.6		3.226	414.72
SHA65T2.75R3GALV		65.0	2.75	3.0	5.315	700.73
SHA65T3GALV	*	65.0	3.0		5.915	762.00
SHA65T4GALV	*	65.0	4.0		7.759	1008.00
SHA65T5GALV	*	65.0	5.0		9.540	1250.00
SHA75T2.5GALV	*	75.0	2.5		5.764	7367.50
SHA75T3GALV	*	75.0	3.0		6.869	882.00
SHA75T3R3GALV	✓	75.0	3.0	3.0	6.808	897.56
SHA75T4GALV	*	75.0	4.0		9.031	1168.00
SHA75T5GALV	*	75.0	5.0		11.130	1450.00
SHA89T3.5GALV	*	89.0	3.5		9.516	1221.50
SHA89T5GALV	*	89.0	5.0		13.356	1730.00
SHA89T6GALV	*	89.0	6.0		15.836	2064.00
SHA90T3R3GALV	✓	90.0	3.0	3.0	7.860	1036.27
SHA100T3GALV	*	100.0	3.0		9.254	182.00
SHA100T3R3GALV	✓	100.0	3.0	3.0	9.193	1211.99
SHA100T4GALV	*	100.0	4.0		12.211	1568.00
SHA100T5GALV	*	100.0	5.0		15.105	1950.00
SHA100T6GALV	*	100.0	6.0		17.935	2328.00





"✓" Stocked Item  
 "✱" Pre-order Only Item  
 (30-40 working days delivery)



# Galvanized Flat Bar

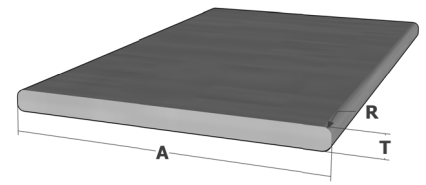

Product Code	Ex Stock	A (mm)	T (mm)	Mass (kg/m)	Area (mm <sup>2</sup> )
FBA20T3GALV	✱	20.0	3.0	0.455	60.00
FBA20T5GALV	✱	20.0	5.0	0.795	100.00
FBA20T6GALV	✱	20.0	6.0	0.954	120.00
FBA25T3GALV	✓	25.0	3.0	0.569	75.00
FBA25T5GALV	✱	25.0	5.0	0.994	125.00
FBA25T6GALV	✱	25.0	6.0	1.193	150.00
FBA30T3GALV	✓	30.0	3.0	0.683	90.00
FBA30T5GALV	✱	30.0	5.0	1.193	150.00
FBA30T6GALV	✱	30.0	6.0	1.431	180.00
FBA30T8GALV	✱	30.0	8.0	1.908	240.00
FBA30T10GALV	✱	30.0	10.0	2.385	300.00
FBA40T3GALV	✱	40.0	3.0	0.954	120.00
FBA40T4GALV	✓	40.0	4.0	1.214	160.00
FBA40T5GALV	✱	40.0	5.0	1.590	200.00
FBA50T4GALV	✱	50.0	4.0	1.517	200.00
FBA60T6GALV	✱	60.0	6.0	2.829	360.00
FBA80T10GALV	✱	80.0	10.0	6.286	800.00
FBA100T3GALV	✱	100.0	12.0	9.430	1200.00

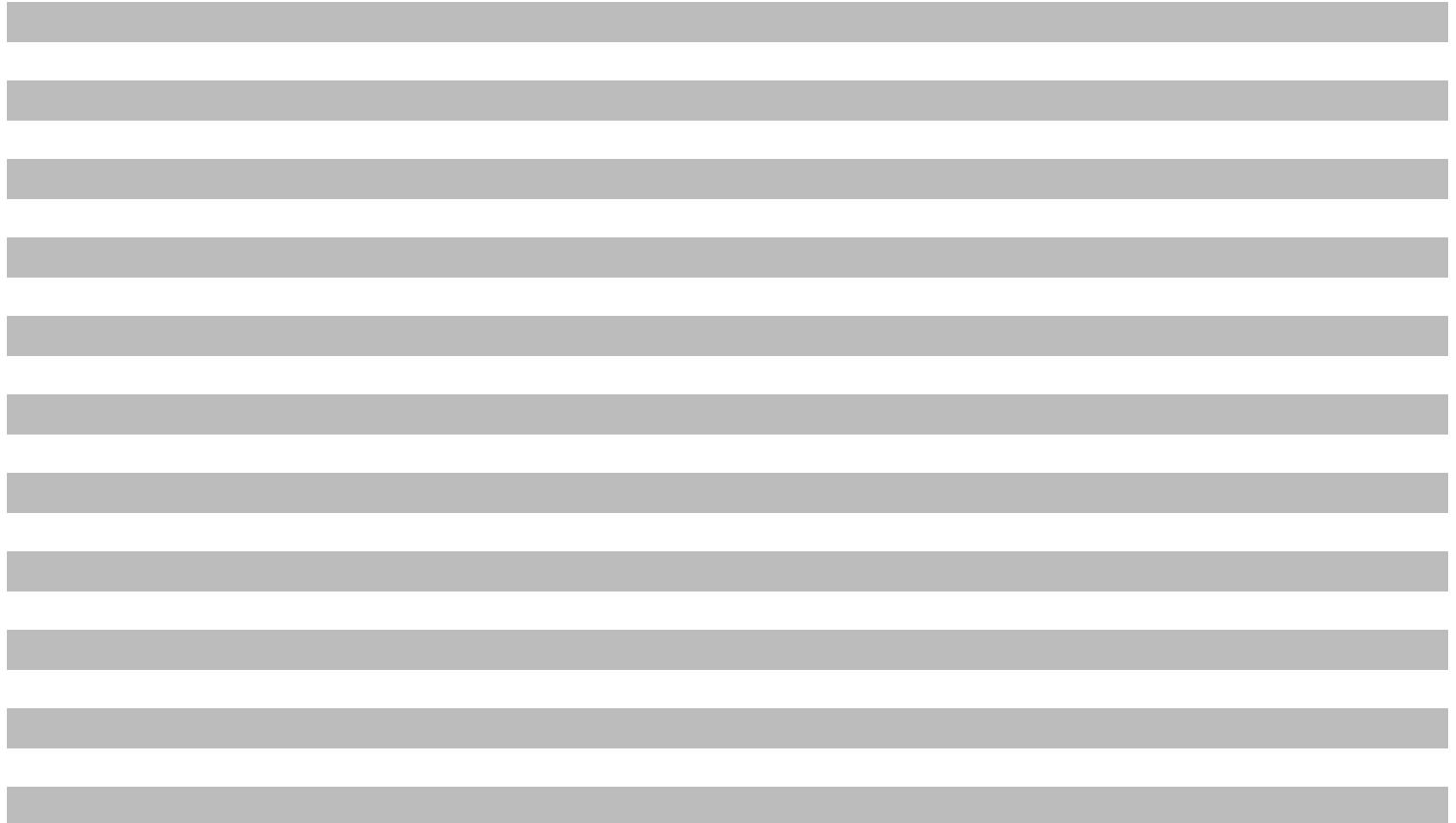

"✓" Stocked Item  
 "\*" Pre-order Only Item  
 (30-40 working days delivery)



## Powder Coated Profiles Square Hollow

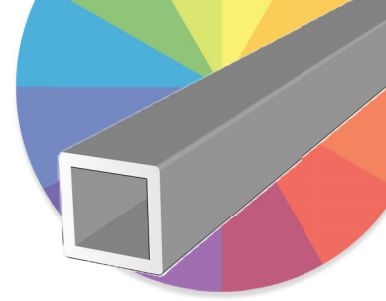

Product Code	Ex Stock	A (mm)	T (mm)	R (mm)	Length (m)	Stocked Colours
SHA19T1.2R2	✓	19.0	1.2	2.0	1.20	Matt Appliance White
SHA19T1.2R2	✓	19.0	1.2	2.0	5.97	Matt Black, Matt Appliance White
SHRA25T1.5R2	✓	25.0	1.5	2.0	5.97	Matt Black, Matt Appliance White
SHRA40T2R3	✓	40.0	2.0	3.0	5.97	Matt Black, Signal White, Dark Cedar, Antique Wood
SHRA50T2R3	✓	50.0	2.0	3.0	5.97	Matt Black, Matt Ironsand, Matt Appliance White
SHRA50T3R3	✓	50.0	3.0	3.0	5.97	Matt Black
SHRA65T2.5R3	✓	65.0	2.5	3.0	5.97	Matt Black
SHRA75T3R3	✓	75.0	3.0	3.0	5.97	Matt Black
SHA100T3	✓	100.0	3.0		3.00	Matt Black, Matt Ironsand
SHA100T3	✓	100.0	3.0		5.97	Matt Black, Matt Appliance White
SHRA100T3	✓	100.0	3.0	3.0	5.97	Matt Black, Matt Appliance White

## Powder Coated Profiles Square Hollow with Screw Holes

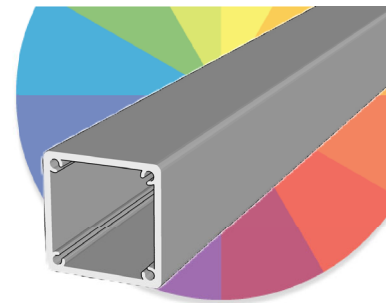

Product Code	Ex Stock	A (mm)	T (mm)	R (mm)	Length (m)	Stocked Colours
GM-NEWZ-50	✓	50.0	2.0	2.0	5.95	Matt Black, Matt Appliance White, Matt Ironsand
GM-NEWZ-49	✓	65.0	2.0	2.0	5.95	Matt Black, Matt Appliance White
GM-NEWZ-48	✓	75.0	2.5	3.0	5.95	Matt Black, Matt Ironsand, Matt Appliance White
GM-NEWZ-47	✓	100.0	4.0		5.95	Matt Black, Matt Ironsand, Matt Appliance White, Signal White

"✓" Stocked Item  
 "✱" Pre-order Only Item  
 (30-40 working days delivery)



## Powder Coated Profiles Rectangular Hollow

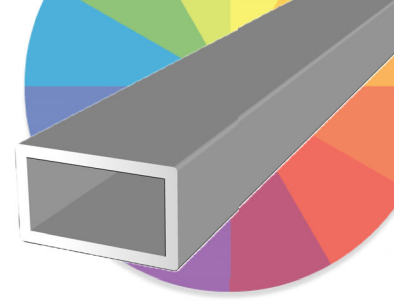

Product Code	Ex Stock	A (mm)	B (mm)	T (mm)	R (mm)	Length (m)	Stocked Colours
GM-NEWZ-127	✓	38.0	25.0	1.5		5.95	Matt Black, Matt Ironsand
GM-NEWZ-61	✓	65.0	16.0	1.2	2.0	5.95	Matt Black, Matt Appliance White
RHA75B40T2	✓	75.0	40.0	2.0		5.95	Matt Black
RHA80B50T3	✓	80.0	50.0	3.0		5.95	Matt Black, Matt Ironsand
RHRA80B50T3R3	✓	80.0	50.0	3.0	3.0	5.95	Matt Black, Matt Ironsand, Matt Appliance White
GM-NEWZ-59	✓	100.0	19.7	1.4		5.95	Matt Black, Dark Cedar, Antique White
GM-NEWZ-60	✓	100.0	19.7	1.4		5.95	Matt Black, Dark Cedar, Matt Appliance White
RHA100B44T3	✓	100.0	44.0	3.0		5.95	Dark Cedar
RHA100B50T3	✓	100.0	50.0	3.0		5.95	Matt Black, Matt Ironsand

## Powder Coated Profiles Equal Angle

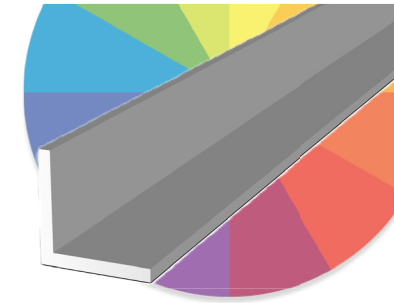

Product Code	Ex Stock	A (mm)	T (mm)	Length (m)	Stocked Colours
EAA12T1.6	✓	12.0	1.6	3.00	Matt Black, Signal White
EAA20T1.6	✓	20.0	1.6	3.00	Matt Black, Signal White
EAA25T1.6	✓	25.0	1.5	3.00	Matt Black, Signal White
EAA25T2.5	✓	25.0	2.5	5.95	Matt Black, Matt Ironsand
EAA30T1.5	✓	30.0	1.5	3.00	Matt Black, Signal White
EAA30T3	✓	30.0	3.0	5.95	Matt Black, Matt Ironsand
EAA40T1.6	✓	40.0	1.6	3.00	Matt Black, Signal White
EAA50T3	✓	50.0	3.0	5.95	Matt Black, Matt Ironsand
EAA50T6	✓	50.0	6.0	5.95	Matt Black, Matt Ironsand



"✓" Stocked Item  
 "\*" Pre-order Only Item  
 (30-40 working days delivery)



## Powder Coated Profiles Round Tube



Product Code	Ex Stock	D (mm)	T (mm)	Length (m)	Stocked Colours
RTD19T1.2	✓	19.0	1.2	5.95	Matt Black, Matt Appliance White
RTD19T1.6	✓	19.0	1.6	5.95	Matt Black, Matt Appliance White
RTD40T0.9	✓	40.0	0.9	5.95	Matt Black, Matt Ironsand, Signal White, Matt Charcoal

## Powder Coated Profiles Flat Bar

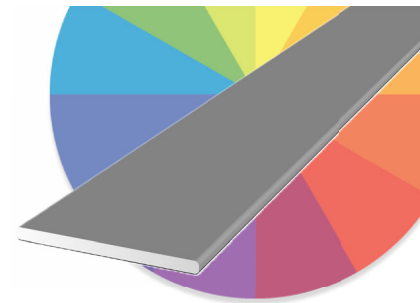

Product Code	Ex Stock	A (mm)	T (mm)	Length (m)	Stocked Colours
FBA25T3	✓	25.0	3.0	5.97	Matt Black
FBA50T3	✓	50.0	3.0	5.97	Matt Black
FBA50T10	✓	50.0	10.0	5.97	Matt Black, Matt Ironsand
FBA70T10	✓	70.0	10.0	6.00	Matt Black
FBA90T6	✓	90.0	6.0	5.40	Matt Black, Matt Appliance, Matt Ironsand, Dark Cedar

## Powder Coated Profiles Channel

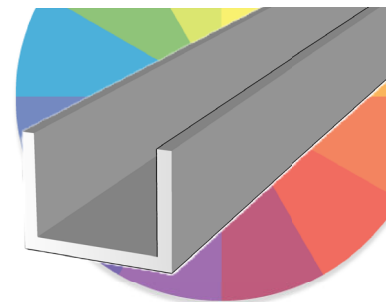

Product Code	Ex Stock	A (mm)	B (mm)	T (mm)	Length (m)	Stocked Colours
CLA50B15T3	✓	50.0	15.0	3.0	5.97	Matt Black, Matt Ironsand
CLA50B50T3	✓	50.0	50.0	3.0	5.95	Matt Black, Matt Ironsand

# Pre-Punched Extrusions

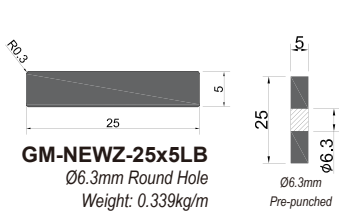
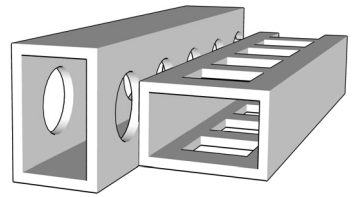

**GM-NEWZ-25x5LB**  
 $\varnothing 6.3$ mm Round Hole  
Weight: 0.339kg/m

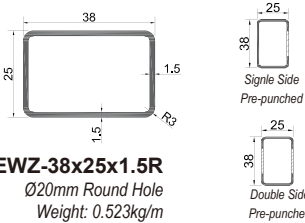
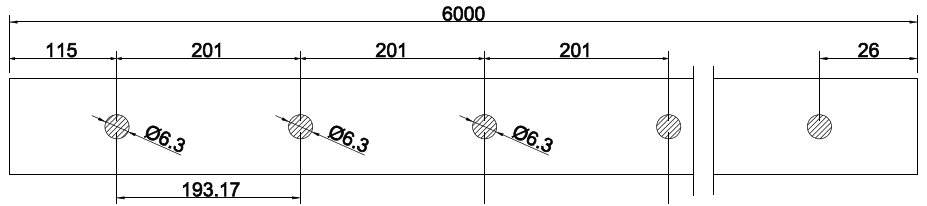

**GM-NEWZ-38x25x1.5R**  
 $\varnothing 20$ mm Round Hole  
Weight: 0.523kg/m

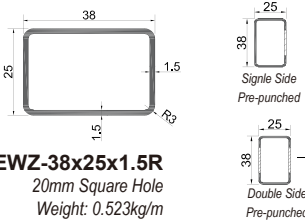
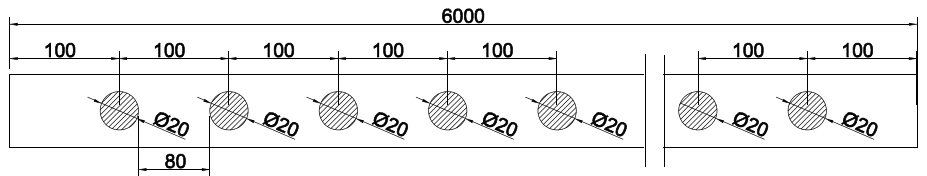

**GM-NEWZ-38x25x1.5R**  
20mm Square Hole  
Weight: 0.523kg/m

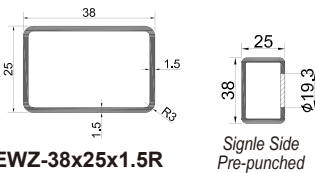
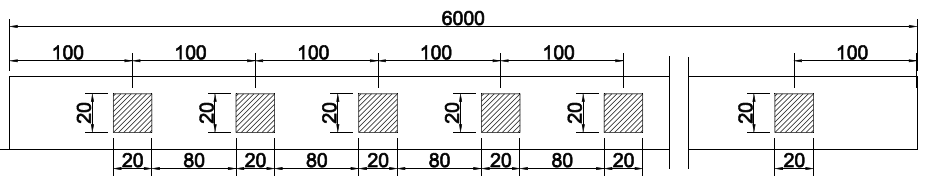

**GM-NEWZ-38x25x1.5R**  
 $\varnothing 20$ mm Round Hole  
Weight: 0.523kg/m

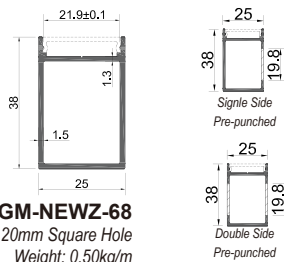
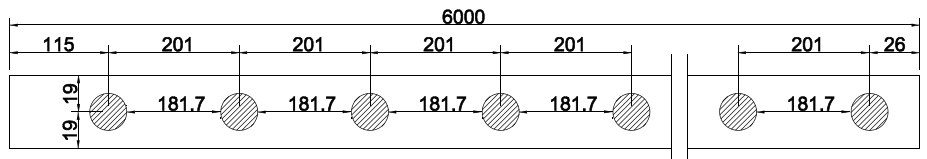

**GM-NEWZ-68**  
20mm Square Hole  
Weight: 0.50kg/m

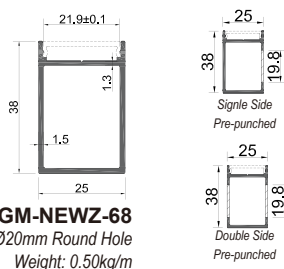
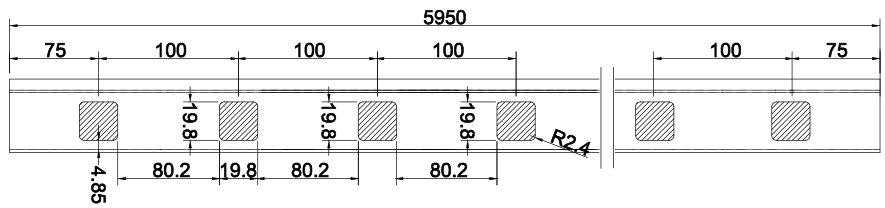

**GM-NEWZ-68**  
 $\varnothing 20$ mm Round Hole  
Weight: 0.50kg/m

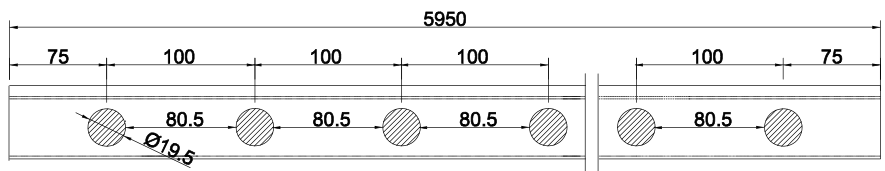

# Pre-Punched Extrusions

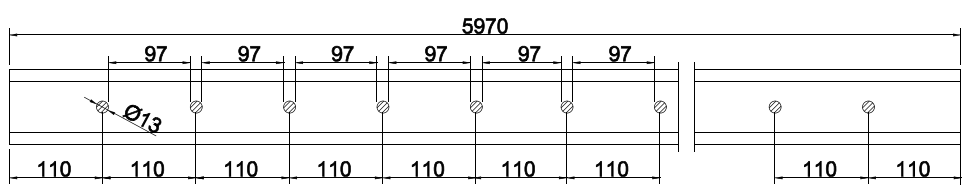
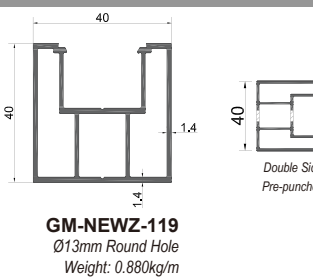
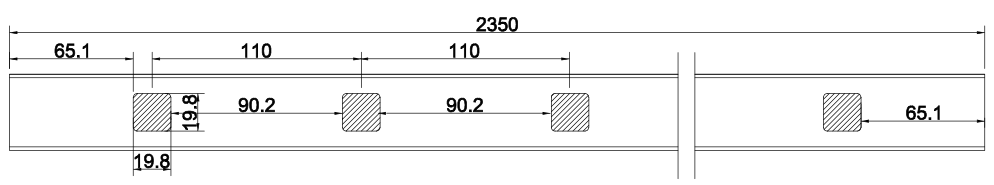
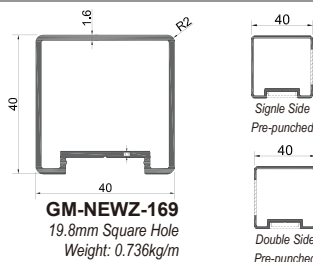
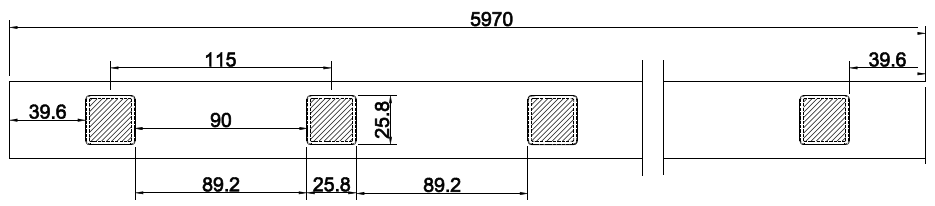
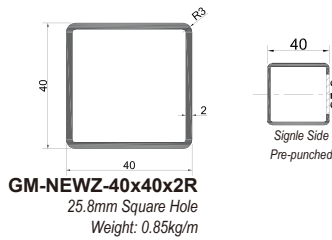
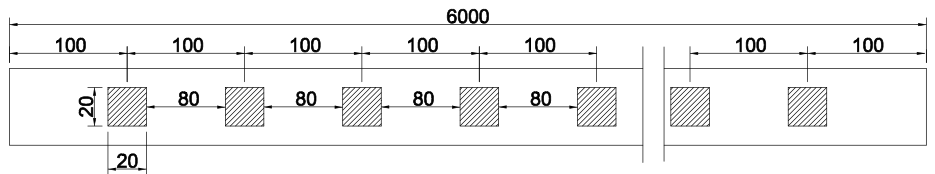
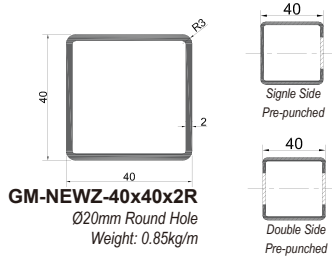
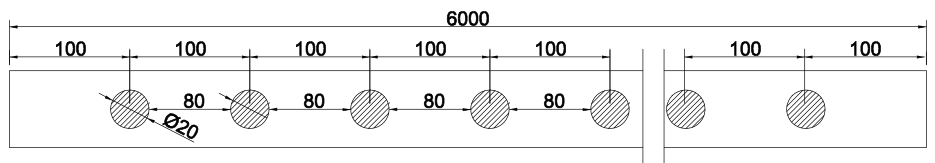
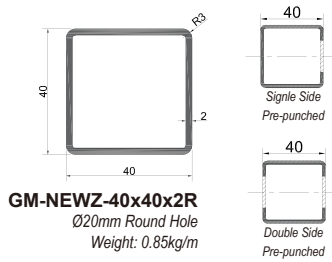
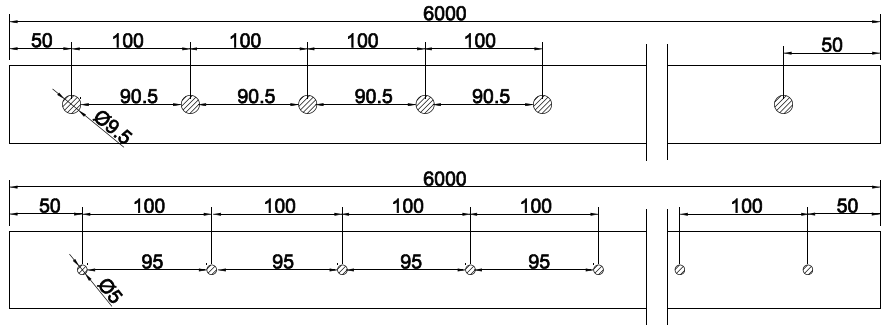
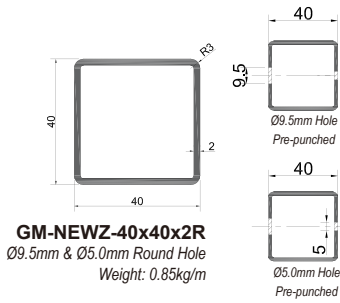
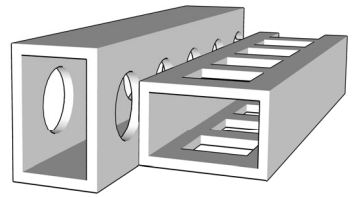

# Pre-Punched Extrusions

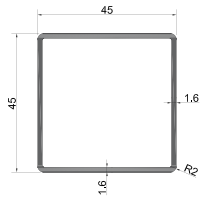
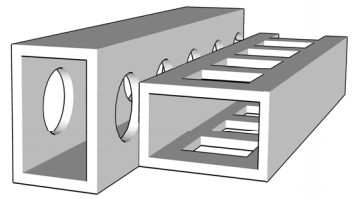

**GM-NEWZ-45x45x1.6R**  
25.6mm Square Hole  
Weight: 0.783kg/m

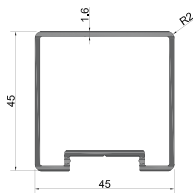
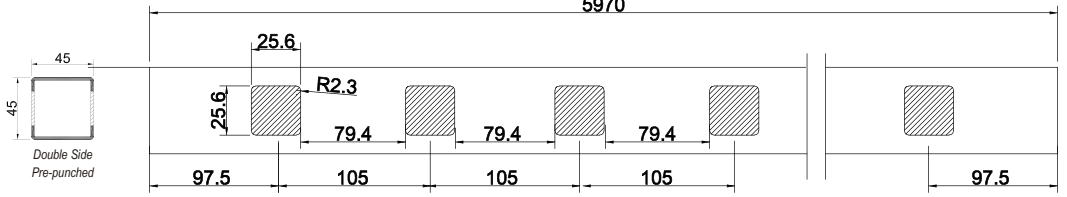

**GM-NEWZ-167**  
25.8mm Square Hole  
Weight: 0.830kg/m

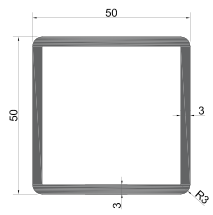
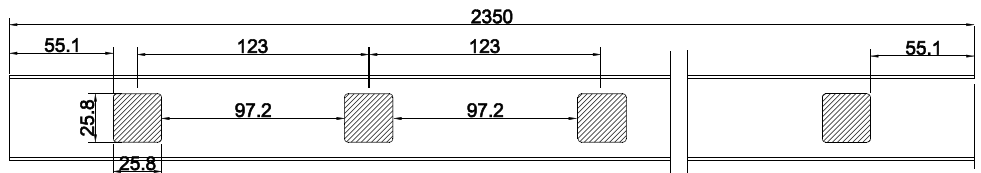
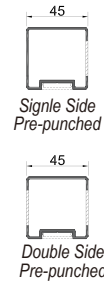

**GM-NEWZ-50x50x3R**  
Ø20mm Round Hole  
Weight: 1.67kg/m

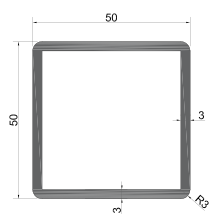
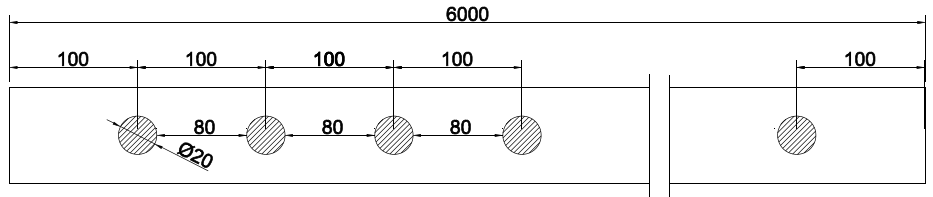
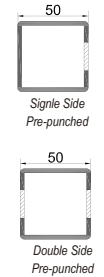

**GM-NEWZ-50x50x3R**  
20mm Square Hole  
Weight: 1.67kg/m

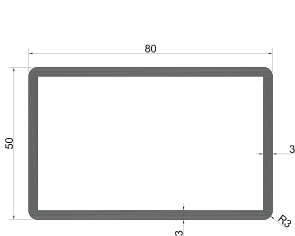
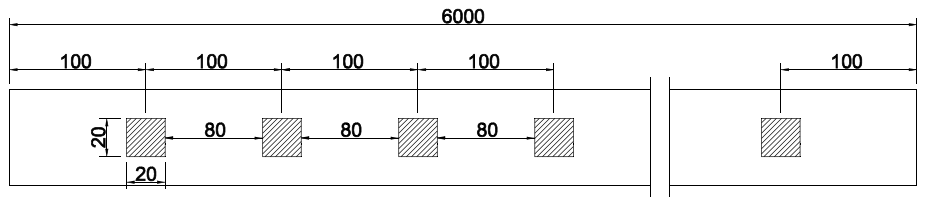
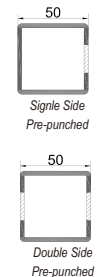

**WZ-80x50x3R**  
Ø20mm Round Hole  
Weight: 2.21kg/m

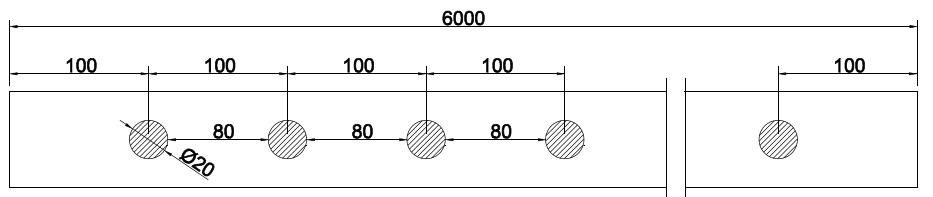
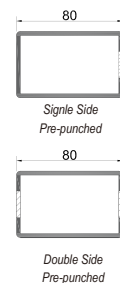

# Pre-Punched Extrusions

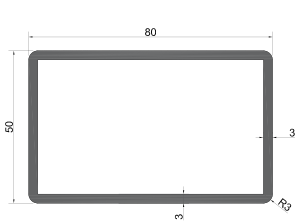
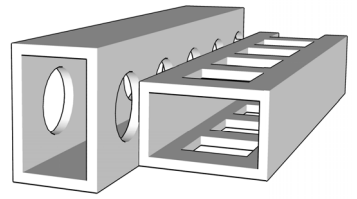

**WZ-80x50x3R**  
20mm Square Hole  
Weight: 2.21kg/m

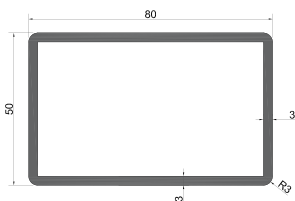
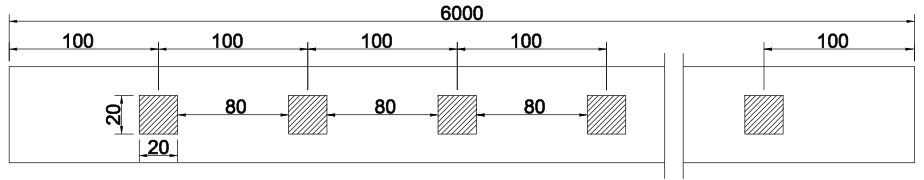
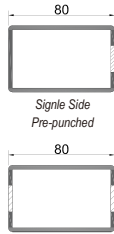

**WZ-80x50x3R**  
25.8mm Square Hole  
Weight: 2.21kg/m

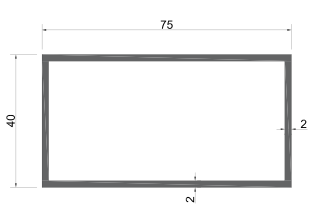
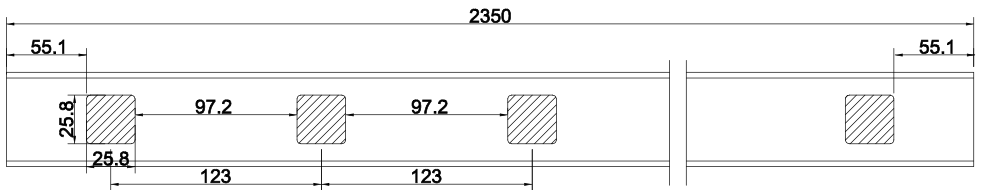
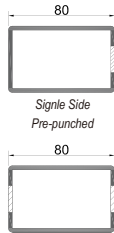

**GM-NEWZ-75x40x2**  
GM-NEWZ-06 Hole  
Weight: 1.33kg/m

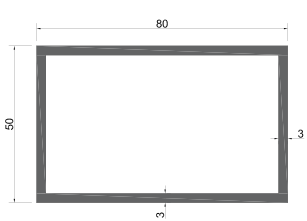
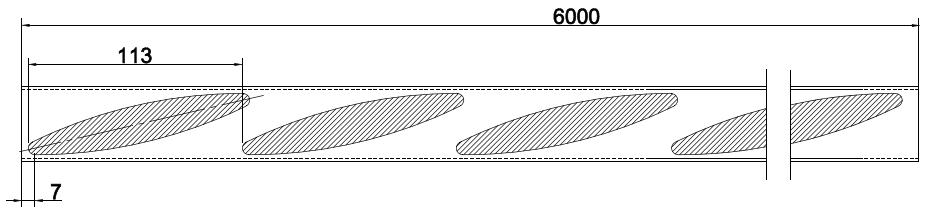
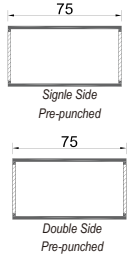

**GM-NEWZ-80x50x3**  
GM-NEWZ-06 Hole  
Weight: 2.33kg/m

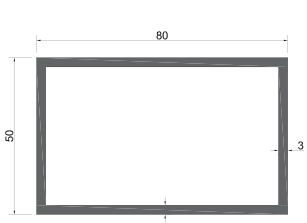
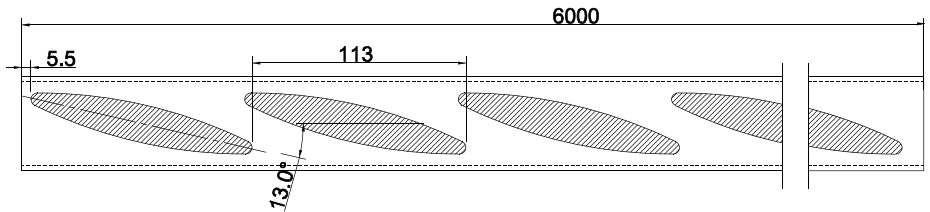
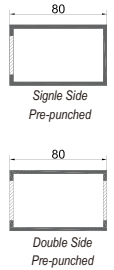

**GM-NEWZ-80x50x3**  
GM-NEWZ-06 Hole  
Weight: 2.33kg/m

